

LOC		DIST		REVISIONS			
P	LTR	DESCRIPTION	DATE	DMN	APVD		
U3		REVISED PER ECR-17-006277	25MAY2017	BW	KR		

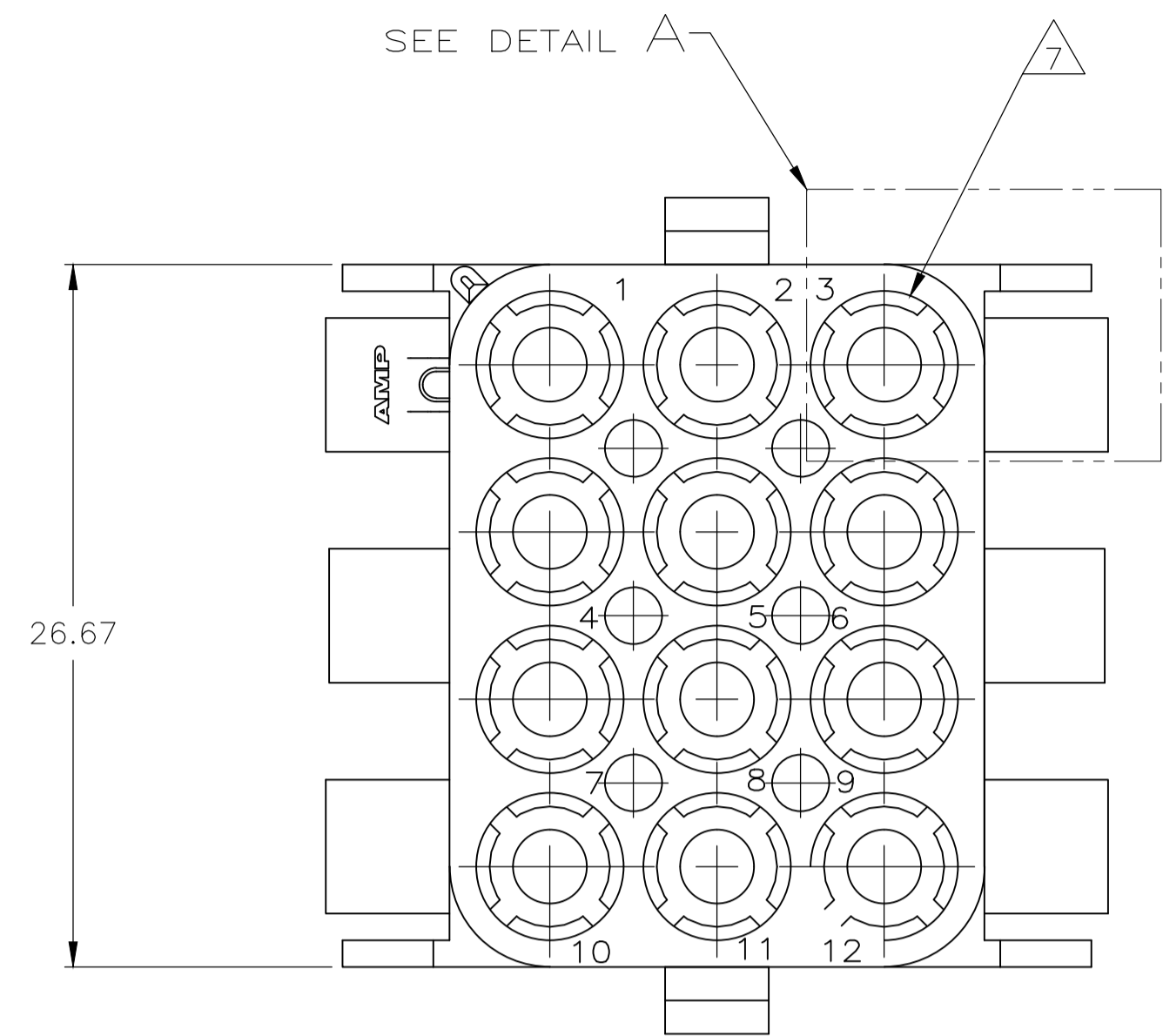

1. MATES WITH APPROPRIATE UNIVERSAL MATE-N-LOK™ PLUG.
2. RECOMMENDED PANEL THICKNESS 0.76 - 2.29.
3. PANEL MUST BE PUNCHED SO THAT THE HOUSING ENTERS THE PANEL IN THE SAME DIRECTION AS THE PUNCH.
4. OPTIONAL FOR KEYING HOUSING IN PANEL.
5. CIRCUIT NUMBER 1 LOCATION.
6. DIMENSIONS SHOWN REPRESENT PRODUCT IN DRY, AS MOLDED, CONDITION. ADDITIONAL 2% GROWTH DUE TO SUBSEQUENT MOISTURE ABSORPTION MAY OCCUR AND SHOULD BE ACCOUNTED FOR.
7. FOUR RIBS EQUALLY SPACED, NO SPECIFIC ORIENTATION. NO RIBS OR SIX RIBS EQUALLY SPACED, NO SPECIFIC ORIENTATION, OPTIONAL.
8. UNDERWRITERS RECOGNIZED COMPONENT LOGO AND CSA CERTIFICATION LOGO TO BE LOCATED ONCE EACH ON SIDE OF HOUSING.

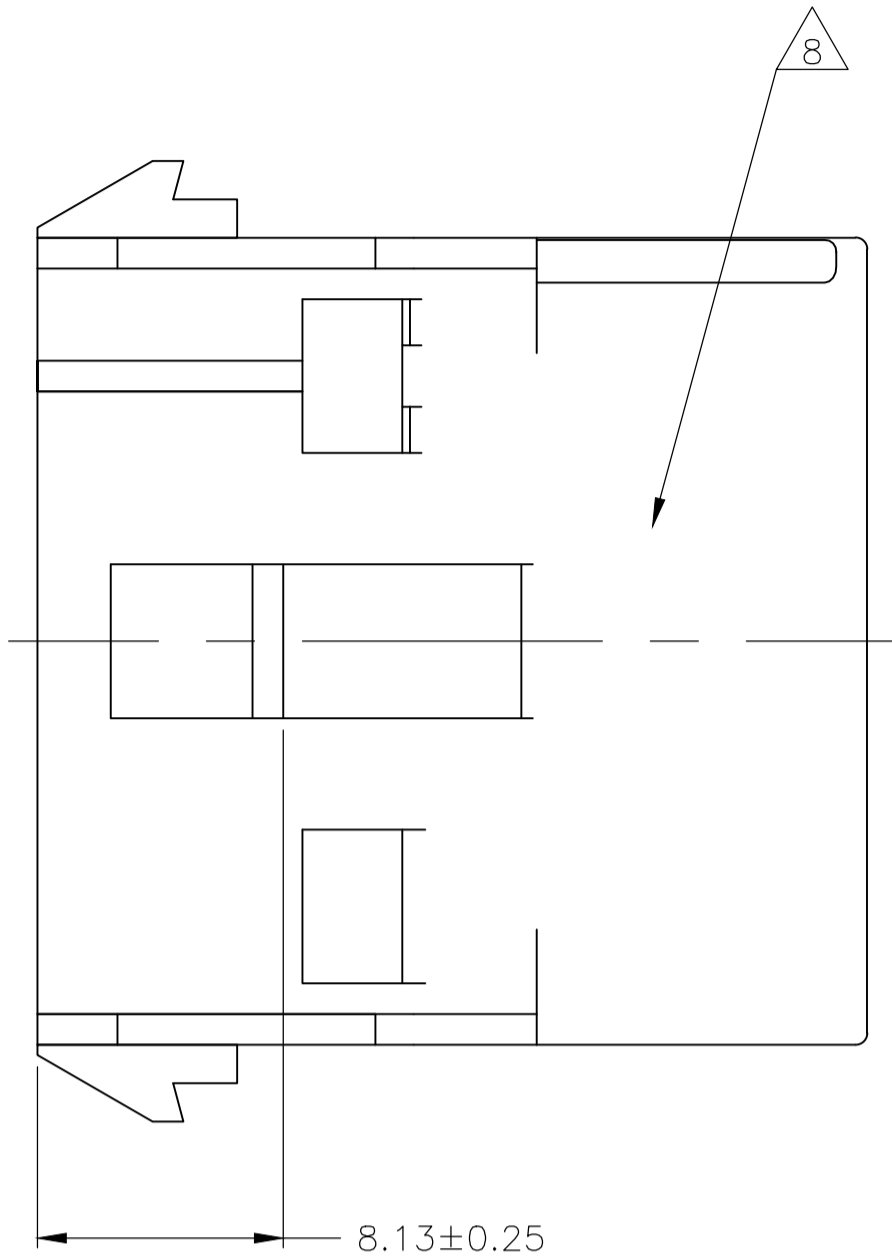
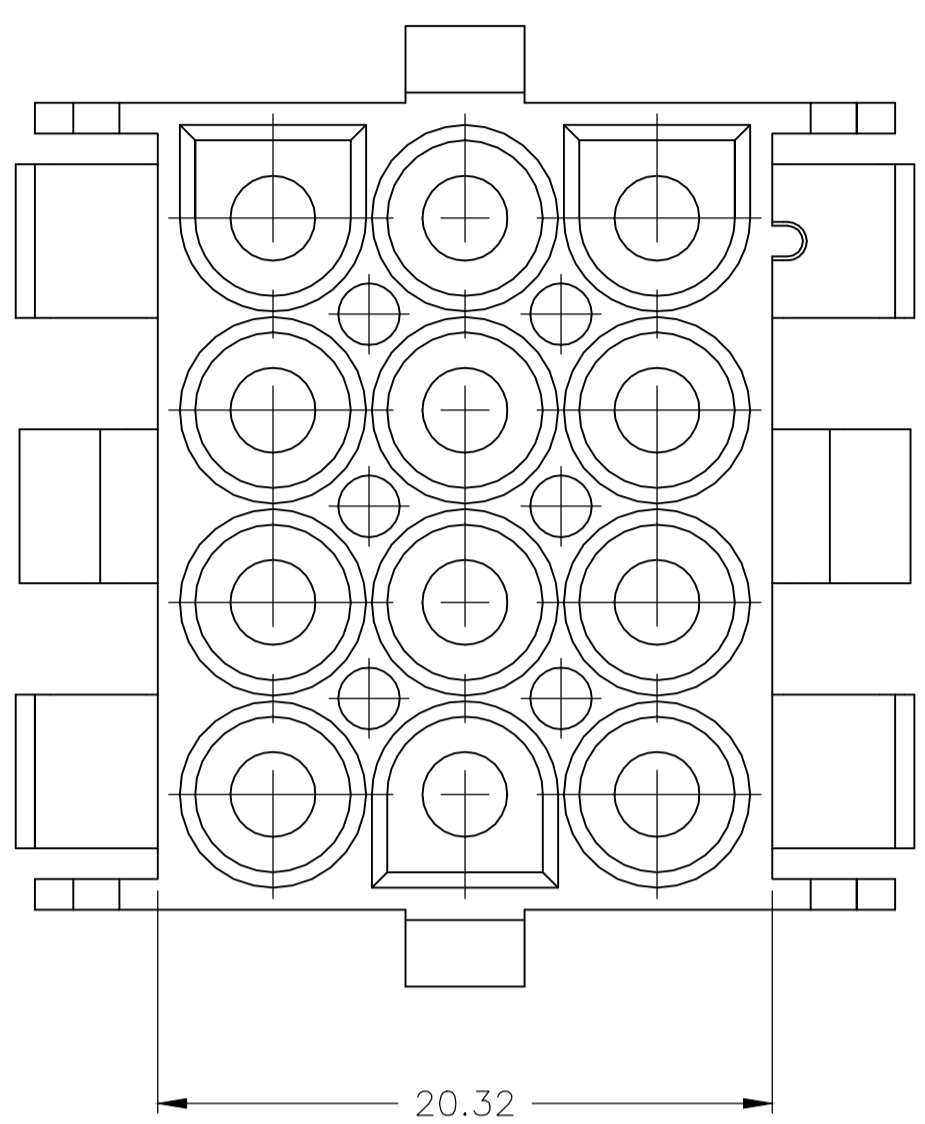
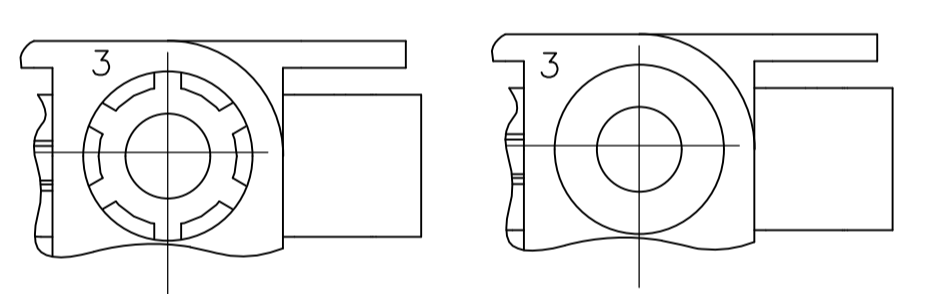

DETAIL A
OPTIONAL CONSTRUCTION

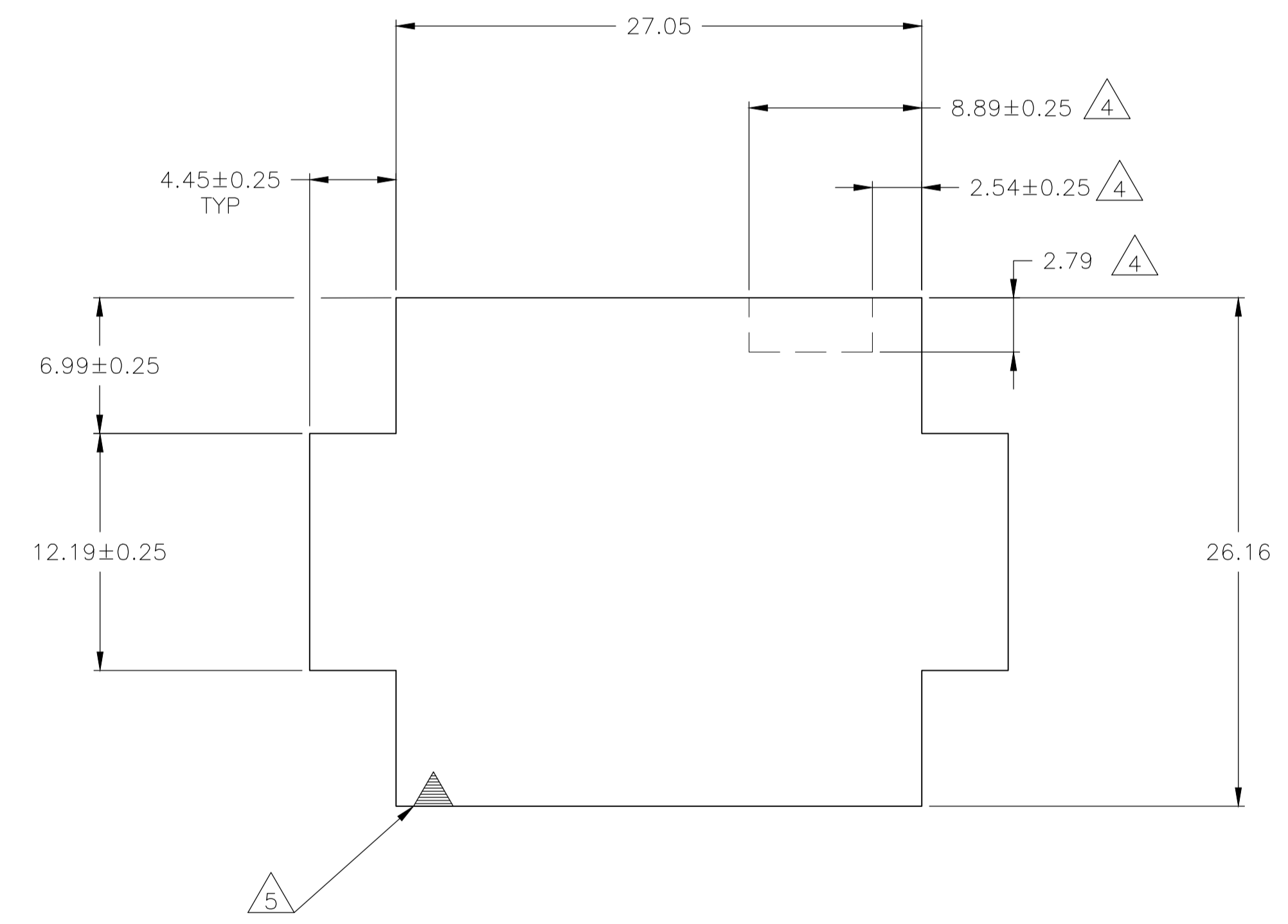
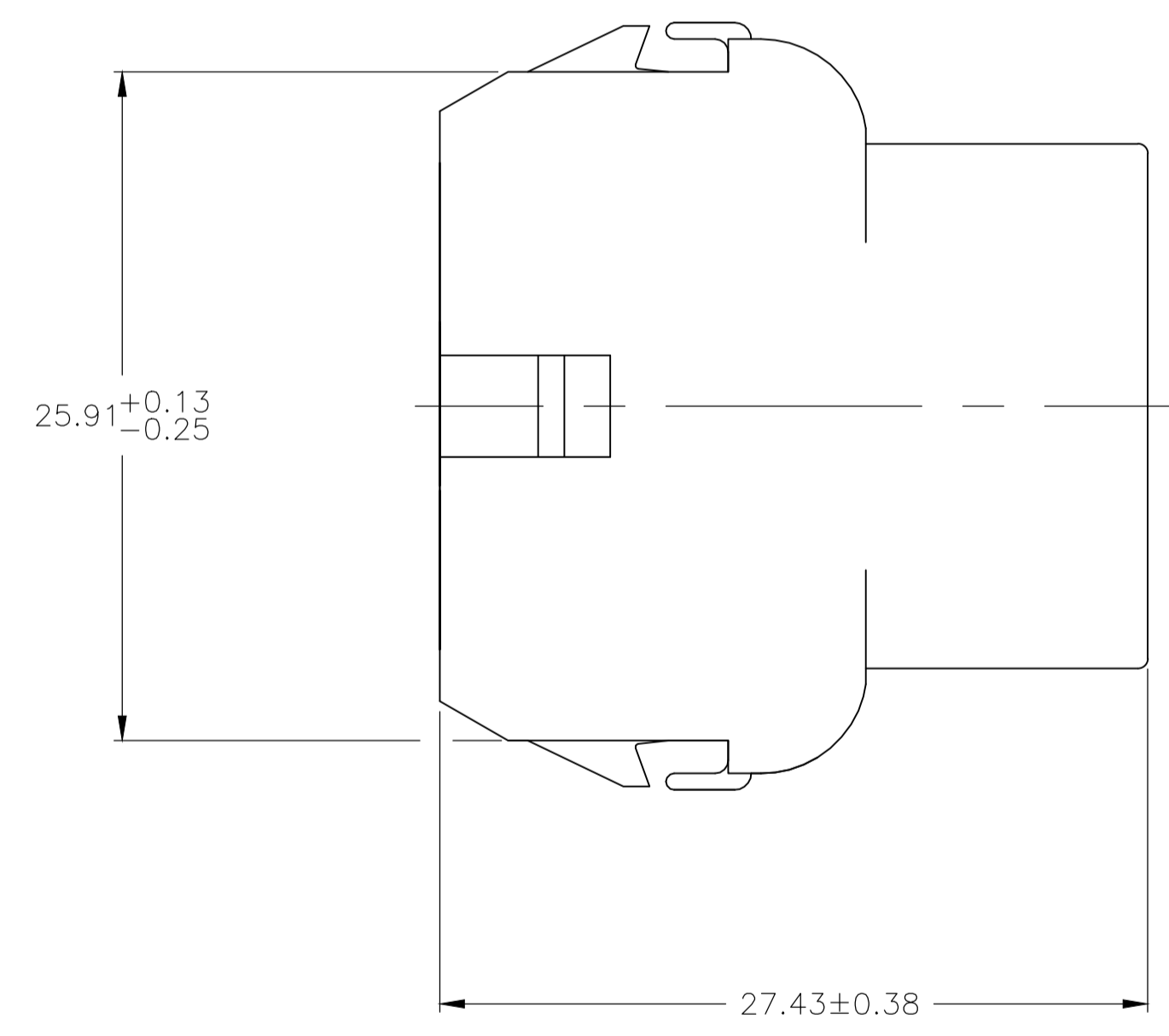

RECOMMENDED PANEL CUT OUT

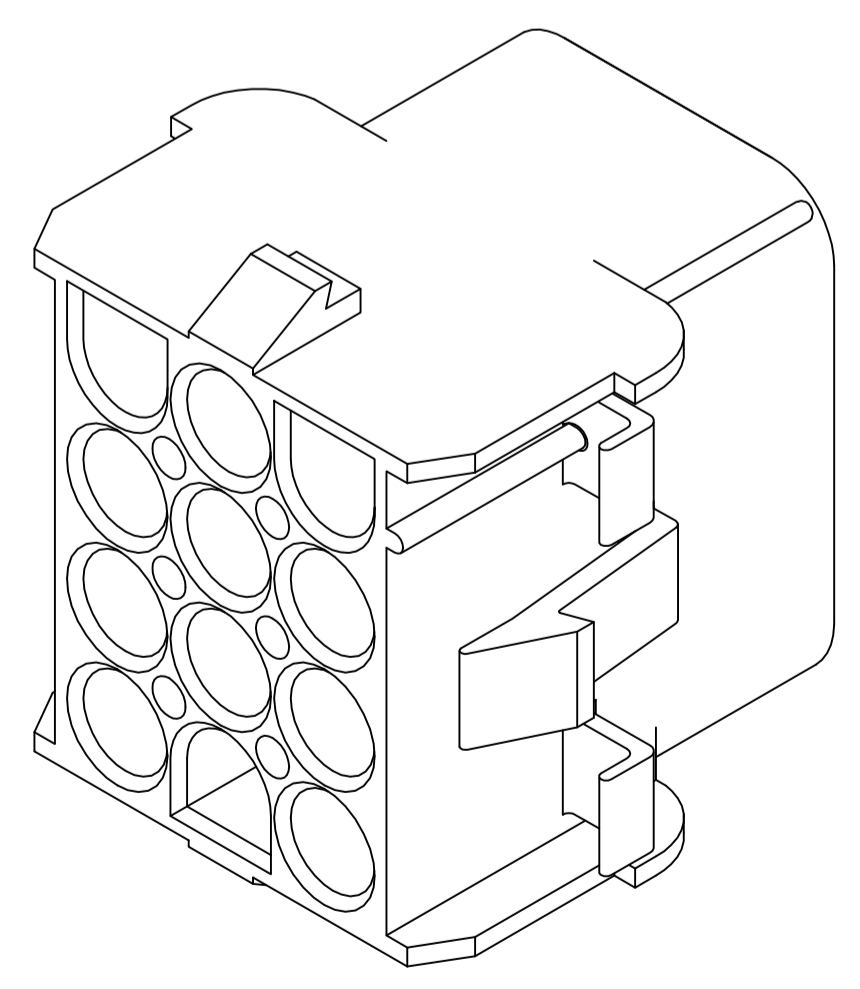

3-DIMENSIONAL MODEL
NTS

6.99	.275	27.43	1.080
4.45	.175	27.05	1.065
2.79	.110	26.67	1.050
2.54	.100	26.16	1.030
2.29	.090	25.91	1.020
0.76	.030	20.32	.800
0.38	.015	12.19	.480
0.25	.010	8.89	.350
0.13	.005	8.13	.320
MM	IN	MM	IN

CONVERSION TABLE

BLACK	1-350783-9
GRAY	1-350783-8
BLUE	1-350783-6
GREEN	1-350783-5
YELLOW	1-350783-4
ORANGE	1-350783-3
RED	1-350783-2
BROWN	1-350783-1
NATURAL	350783-1
COLOR	PART NO.

THIS DRAWING IS A CONTROLLED DOCUMENT.

DIMENSIONS:	TOLERANCES UNLESS OTHERWISE SPECIFIED:	DIN K. WHITAKER 28MAY92	TE Connectivity
mm	0. PLC ± -	CHK R. SWING 28MAY92	NAME CAP.12 CIRCUIT, UNIVERSAL MATE-N-LOK™
	1. PLC ± -	APVD D. SELF 02JUN92	PRODUCT SPEC
	2. PLC ± 0.13	APPLICATION SPEC	SIZE CAGE CODE DRAWING NO
	3. PLC ± -	WEIGHT	A1 00779 350783
	4. PLC ± -	CUSTOMER DRAWING	SCALE 4:1 SHEET 1 OF 1 REV U3
	ANGLES ± 1°		
MATERIAL NYLON,UL 94V-0	FINISH -		