

TPS76425, TPS76427, TPS76428, TPS76430, TPS76433 LOW-POWER LOW-NOISE 150-mA LOW-DROPOUT LINEAR REGULATORS

SLVS180A – MARCH 1999 – REVISED JUNE 1999

- 150-mA Low Noise, Low-Dropout Regulator
- Output Voltage: 2.5 V, 2.7 V, 2.8 V, 3.0 V, 3.3 V
- Output Noise Typically 50 μ V
- Quiescent Current Typically 85 μ A
- Dropout Voltage, Typically 300 mV at 150 mA
- Thermal Protection
- Over Current Limitation
- Less Than 2- μ A Quiescent Current in Shutdown Mode
- -40°C to 125°C Operating Junction Temperature Range
- 5-Pin SOT-23 (DBV) Package

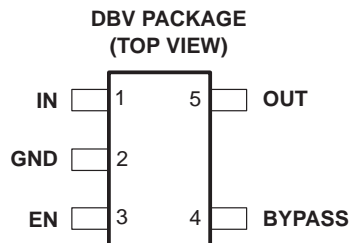

description

The TPS764xx family of low-dropout (LDO) voltage regulators offers the benefits of a low noise, low-dropout voltage, low-power operation, and miniaturized package. Additionally, they feature low quiescent current when compared to conventional LDO regulators. Offered in 5-terminal small outline integrated-circuit SOT-23 package, the TPS764xx series devices are ideal for low-noise applications, cost-sensitive designs and applications where board space is at a premium.

A combination of new circuit design and process innovation has enabled the usual pnp pass transistor to be replaced by a PMOS pass element. Because the PMOS pass element behaves as a low-value resistor, the dropout voltage is very low—typically 300 mV at 150 mA of load current (TPS76433)—and is directly proportional to the load current. Since the PMOS pass element is a voltage-driven device, the quiescent current is very low (140 μ A maximum) and is stable over the entire range of output load current (0 mA to 150 mA). Intended for use in portable systems such as laptops and cellular phones, the low-dropout voltage feature and low-power operation result in a significant increase in system battery operating life.

The TPS764xx also features a logic-enabled sleep mode to shut down the regulator, reducing quiescent current to 1 μ A maximum at $T_J = 25^\circ\text{C}$. The TPS764xx is offered in 2.5-V, 2.7-V, 2.8-V, 3.0-V, and 3.3-V fixed-voltages.

AVAILABLE OPTIONS

T_J	VOLTAGE	PACKAGE	PART NUMBER		SYMBOL
-40°C to 125°C	2.5 V	SOT-23 (DBV)	TPS76425DBVT†	TPS76425DBVR‡	PBJI
	2.7 V		TPS76427DBVT†	TPS76427DBVR‡	PBKI
	2.8 V		TPS76428DBVT†	TPS76428DBVR‡	PCEI
	3.0 V		TPS76430DBVT†	TPS76430DBVR‡	PBLI
	3.3 V		TPS76433DBVT†	TPS76433DBVR‡	PBMI

† The DBVT passive indicates tape and reel of 250 parts.

‡ The DBVR passive indicates tape and reel of 3000 parts.



Please be aware that an important notice concerning availability, standard warranty, and use in critical applications of Texas Instruments semiconductor products and disclaimers thereto appears at the end of this data sheet.

PRODUCTION DATA information is current as of publication date. Products conform to specifications per the terms of Texas Instruments standard warranty. Production processing does not necessarily include testing of all parameters.

 **TEXAS
INSTRUMENTS**

POST OFFICE BOX 655303 • DALLAS, TEXAS 75265

Copyright © 1999, Texas Instruments Incorporated

TPS76425, TPS76427, TPS76428, TPS76430, TPS76433 LOW-POWER LOW-NOISE 150-mA LOW-DROPOUT LINEAR REGULATORS

SLVS180A – MARCH 1999 – REVISED JUNE 1999

functional block diagram

TPS76425/ 27/ 28/ 30/ 33

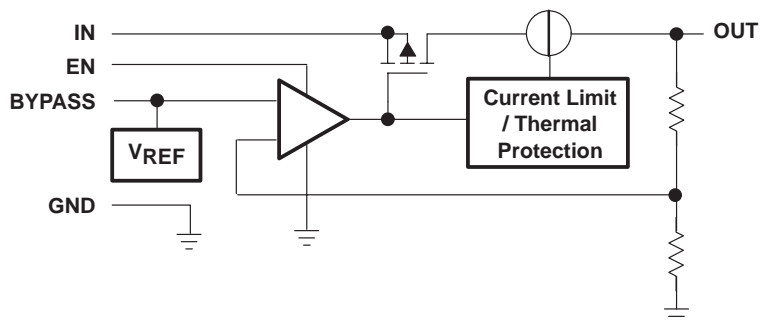

Terminal Functions

TERMINAL NAME	I/O	DESCRIPTION
GND		Ground
EN	I	Enable input
BYPASS		Output bypass capacitor
IN	I	Input supply voltage
OUT	O	Regulated output voltage

TPS76425, TPS76427, TPS76428, TPS76430, TPS76433 LOW-POWER LOW-NOISE 150-mA LOW-DROPOUT LINEAR REGULATORS

SLVS180A – MARCH 1999 – REVISED JUNE 1999

absolute maximum ratings over operating free-air temperature range (unless otherwise noted)†

Input voltage range (see Note 1)	–0.3 V to 10 V
Voltage range at EN	–0.3 V to $V_I + 0.3$ V
Voltage on OUT,	7 V
Peak output current	Internally limited
ESD rating, HBM	2 kV
Continuous total power dissipation	See dissipation rating tables
Operating virtual junction temperature range, T_J	–40°C to 150°C
Storage temperature range, T_{stg}	–65°C to 150°C

† Stresses beyond those listed under “absolute maximum ratings” may cause permanent damage to the device. These are stress ratings only, and functional operation of the device at these or any other conditions beyond those indicated under “recommended operating conditions” is not implied. Exposure to absolute-maximum-rated conditions for extended periods may affect device reliability.

NOTE 1: All voltage values are with respect to network ground terminal.

DISSIPATION RATING TABLE

	PACKAGE	$T_A \leq 25^\circ\text{C}$ POWER RATING	DERATING FACTOR ABOVE $T_A = 25^\circ\text{C}$	$T_A = 70^\circ\text{C}$ POWER RATING	$T_A = 85^\circ\text{C}$ POWER RATING
Recommended	DBV	350 mW	3.5 mW/°C	192 mW	140 mW
Maximum	DBV	437 mW	3.5 mW/°C	280 mW	227 mW

recommended operating conditions

	MIN	NOM	MAX	UNIT
Input voltage, V_I †	2.7		10	V
Continuous output current, I_O	0		150	mA
Operating junction temperature, T_J	–40		125	°C

† To calculate the minimum input voltage for your maximum output current, use the following equation: $V_{I(\min)} = V_{O(\max)} + V_{DO(\max \text{ load})}$



TPS76425, TPS76427, TPS76428, TPS76430, TPS76433

LOW-POWER LOW-NOISE 150-mA LOW-DROPOUT LINEAR REGULATORS

SLVS180A – MARCH 1999 – REVISED JUNE 1999

electrical characteristics over recommended operating free-air temperature range, $V_I = V_{O(typ)} + 1\text{ V}$, $I_O = 1\text{ mA}$, $EN = IN$, $C_O = 4.7\text{ }\mu\text{F}$ (unless otherwise noted)

PARAMETER		TEST CONDITIONS		MIN	TYP	MAX	UNIT
V _O	Output voltage	TPS76425	I _O = 1 mA to 100 mA, T _J = 25°C	2.45	2.5	2.55	V
			I _O = 1 mA to 100 mA	2.425	2.5	2.575	
			I _O = 1 mA to 150 mA, T _J = 25°C	2.438	2.5	2.562	
			I _O = 1 mA to 150 mA	2.407	2.5	2.593	
		TPS76427	I _O = 1 mA to 100 mA, T _J = 25°C	2.646	2.7	2.754	V
			I _O = 1 mA to 100 mA	2.619	2.7	2.781	
			I _O = 1 mA to 150 mA, T _J = 25°C	2.632	2.7	2.768	
			I _O = 1 mA to 150 mA	2.598	2.7	2.8013	
		TPS76428	I _O = 1 mA to 100 mA, T _J = 25°C	2.744	2.8	2.856	V
			I _O = 1 mA to 150 mA,	2.73	2.8	2.870	
			I _O = 1 mA to 150 mA, T _J = 25°C	2.716	2.8	2.884	
			I _O = 1 mA to 150 mA	2.695	2.8	2.905	
		TPS76430	I _O = 1 mA to 100 mA, T _J = 25°C	2.94	3.0	3.06	V
			I _O = 1 mA to 100 mA	2.925	3.0	3.075	
			I _O = 1 mA to 150 mA, T _J = 25°C	2.91	3.0	3.090	
			I _O = 1 mA to 150 mA	2.887	3.0	3.112	
TPS76433	I _O = 1 mA to 100 mA, T _J = 25°C	3.234	3.3	3.366	V		
	I _O = 1 mA to 100 mA	3.201	3.3	3.399			
	I _O = 1 mA to 150 mA, T _J = 25°C	3.218	3.3	3.382			
	I _O = 1 mA to 150 mA	3.177	3.3	3.423			
I _(Q)	Quiescent current (GND terminal current)	I _O = 0 to 150 mA, T _J = 25°C, See Note 2		85	100	μA	
		I _O = 0 to 150 mA, See Note 2			140		
	Standby current	EN < 0.5 V, T _J = 25°C		0.5	1		
		EN < 0.5 V			2		
V _n	Output noise voltage	BW = 300 Hz to 50 kHz, C _O = 10 μF, T _J = 25°C, See Note 2		50		μV	
	Bypass voltage	T _J = 25°C		1.192		V	
PSRR	Ripple rejection	f = 1 kHz, C _O = 10 μF, T _J = 25°C, See Note 2		60		dB	
	Current limit	T _J = 25°C See Note 3		0.8	1.5	A	

NOTES: 2. Minimum IN operating voltage is 2.7 V or V_{O(typ)} + 1 V, whichever is greater.
 3. Test condition includes, output voltage V_O=0 V and pulse duration = 10 mS.



TPS76425, TPS76427, TPS76428, TPS76430, TPS76433

LOW-POWER LOW-NOISE 150-mA LOW-DROPOUT LINEAR REGULATORS

SLVS180A – MARCH 1999 – REVISED JUNE 1999

electrical characteristics over recommended operating free-air temperature range, $V_I = V_{O(\text{typ})} + 1 \text{ V}$, $I_O = 1 \text{ mA}$, $EN = IN$, $C_O = 4.7 \mu\text{F}$ (unless otherwise noted) (continued)

PARAMETER		TEST CONDITIONS	MIN	TYP	MAX	UNIT	
Output voltage line regulation ($\Delta V_O/V_O$) (see Note 4)		$V_O + 1 \text{ V} < V_I \leq 10 \text{ V}$, $V_I \geq 3.5 \text{ V}$, $T_J = 25^\circ\text{C}$		0.04	0.07	%V	
		$V_O + 1 \text{ V} < V_I \leq 10 \text{ V}$, $V_I \geq 3.5 \text{ V}$			0.1		
V_{IH}	EN high level input	See Note 2		1.4	2	V	
V_{IL}	EN low level input	See Note 2	0.5	1.2			
I_I	EN input current	EN = 0 V		-0.01	-0.5	μA	
		EN = IN		-0.01	-0.5		
V_{DO}	Dropout voltage (Note 5)	TPS76425	$I_O = 0 \text{ mA}$, $T_J = 25^\circ\text{C}$		0.2	mV	
			$I_O = 1 \text{ mA}$, $T_J = 25^\circ\text{C}$		3		
			$I_O = 50 \text{ mA}$, $T_J = 25^\circ\text{C}$		120		150
			$I_O = 50 \text{ mA}$				200
			$I_O = 75 \text{ mA}$, $T_J = 25^\circ\text{C}$		180		225
			$I_O = 75 \text{ mA}$				300
			$I_O = 100 \text{ mA}$, $T_J = 25^\circ\text{C}$		240		300
			$I_O = 100 \text{ mA}$				400
			$I_O = 150 \text{ mA}$, $T_J = 25^\circ\text{C}$		360		450
			$I_O = 150 \text{ mA}$				600
		TPS76433	$I_O = 0 \text{ mA}$, $T_J = 25^\circ\text{C}$		0.2	mV	
			$I_O = 1 \text{ mA}$, $T_J = 25^\circ\text{C}$		3		
			$I_O = 50 \text{ mA}$, $T_J = 25^\circ\text{C}$		100		125
			$I_O = 50 \text{ mA}$				166
			$I_O = 75 \text{ mA}$, $T_J = 25^\circ\text{C}$		150		188
			$I_O = 75 \text{ mA}$				250
			$I_O = 100 \text{ mA}$, $T_J = 25^\circ\text{C}$		200		250
			$I_O = 100 \text{ mA}$				333
			$I_O = 150 \text{ mA}$, $T_J = 25^\circ\text{C}$		300		375
			$I_O = 150 \text{ mA}$				500

- NOTES: 2. Minimum IN operating voltage is 2.7 V or $V_{O(\text{typ})} + 1 \text{ V}$, whichever is greater.
4. If $V_O < 2.5 \text{ V}$ and $V_{i\text{max}} = 10 \text{ V}$, $V_{i\text{min}} = 3.5 \text{ V}$:

$$\text{Line Reg. (mV)} = (\%/V) \times \frac{V_O(V_{i\text{max}} - 3.5 \text{ V})}{100} \times 1000$$

If $V_O > 2.5 \text{ V}$ and $V_{i\text{max}} = 10 \text{ V}$, $V_{i\text{min}} = V_O + 1 \text{ V}$:

$$\text{Line Reg. (mV)} = (\%/V) \times \frac{V_O(V_{i\text{max}} - (V_O + 1))}{100} \times 1000$$

5. Dropout voltage is defined as the differential voltage between V_O and V_I when V_O drops 100 mV below the value measured with $V_I = V_O + 1.0 \text{ V}$.:



TPS76425, TPS76427, TPS76428, TPS76430, TPS76433 LOW-POWER LOW-NOISE 150-mA LOW-DROPOUT LINEAR REGULATORS

SLVS180A – MARCH 1999 – REVISED JUNE 1999

TYPICAL CHARACTERISTICS

Table of Graphs

			FIGURE
V_O	Output voltage	vs Output current	1
		vs Free-air temperature	2, 3, 4
V_n	Output noise	vs Frequency	5
V_n	Output noise voltage	vs Bypass capacitance	6
		vs Load current	7
Z_o	Output impedance	vs Frequency	8
V_{DO}	Dropout voltage	vs Free-air temperature	9
		Ripple rejection	vs Frequency
	Line transient response		11, 13
	Load transient response		12, 14
	Compensation series resistance (CSR)	vs Output current	15, 17
		vs Added ceramic capacitance	16, 18

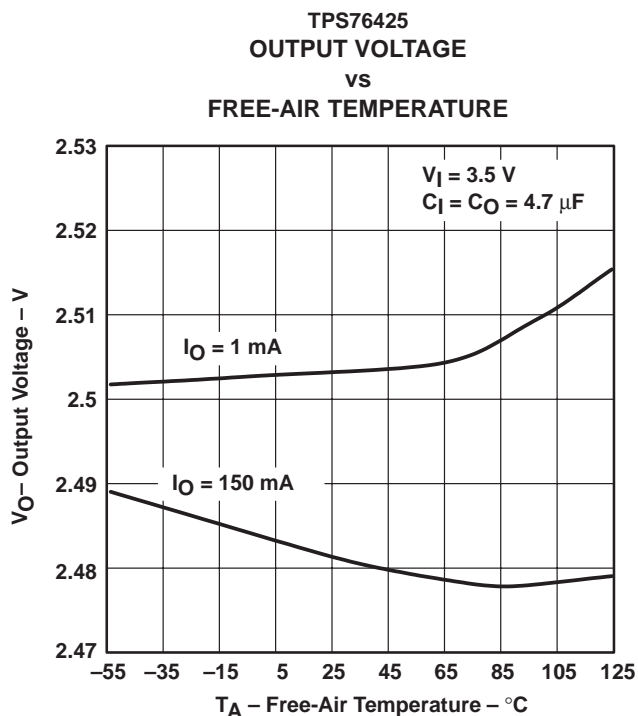
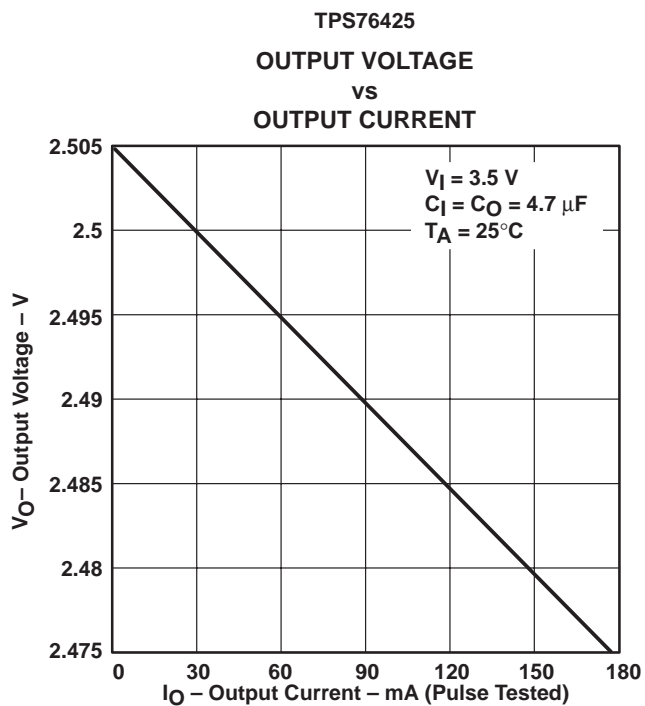

TYPICAL CHARACTERISTICS

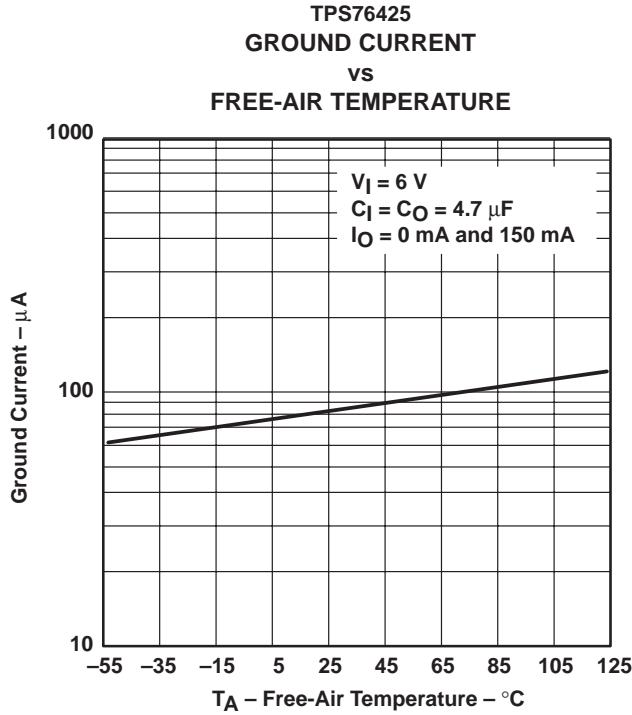

Figure 3

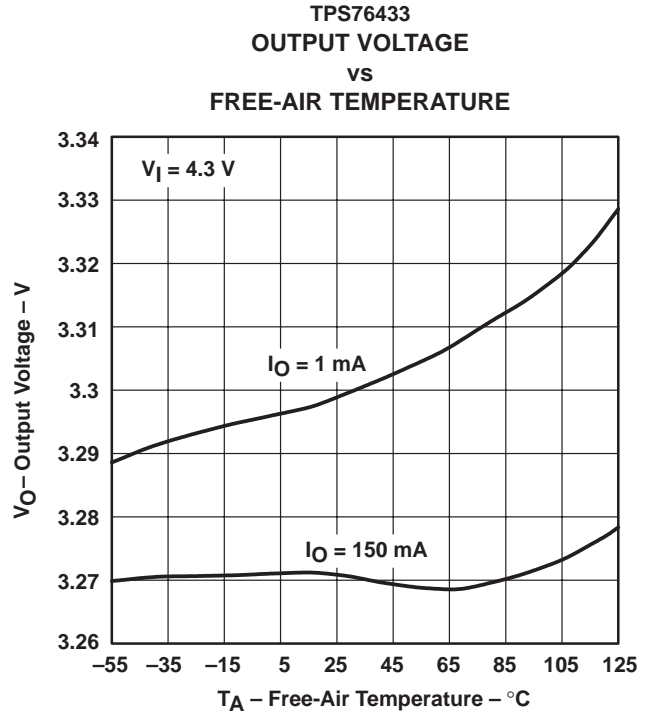

Figure 4

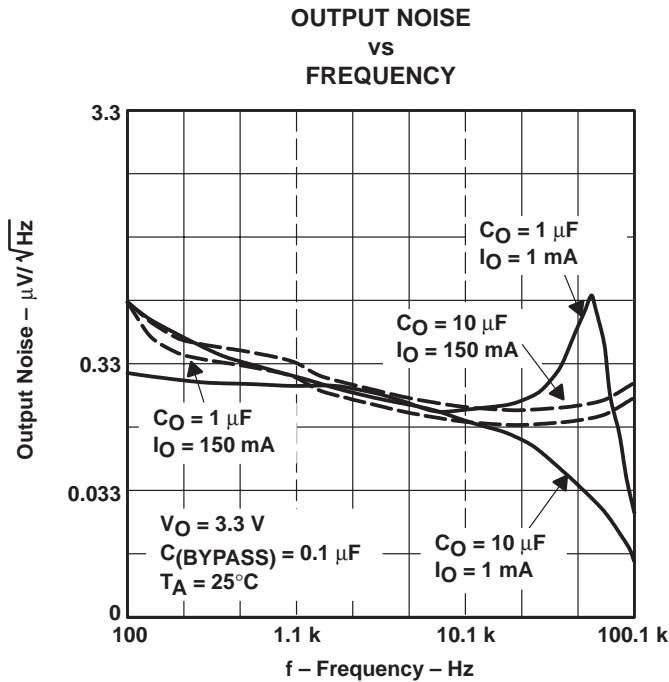

Figure 5

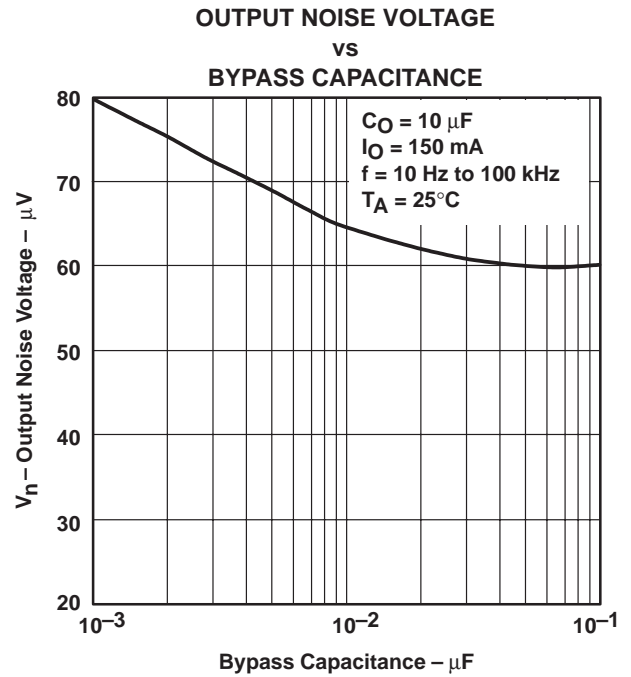
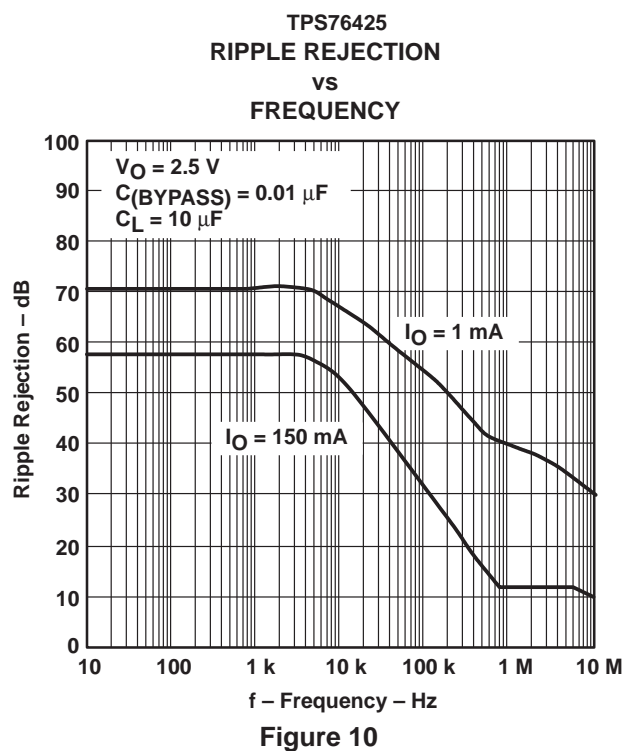
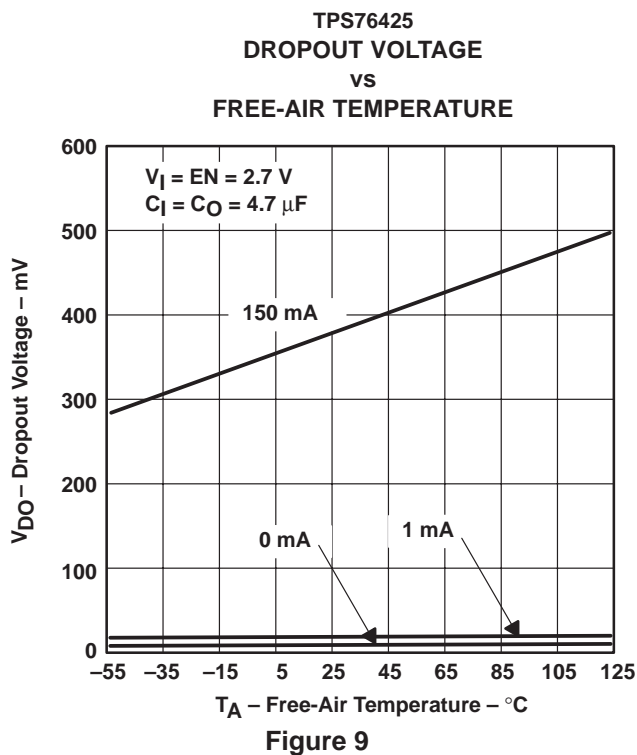
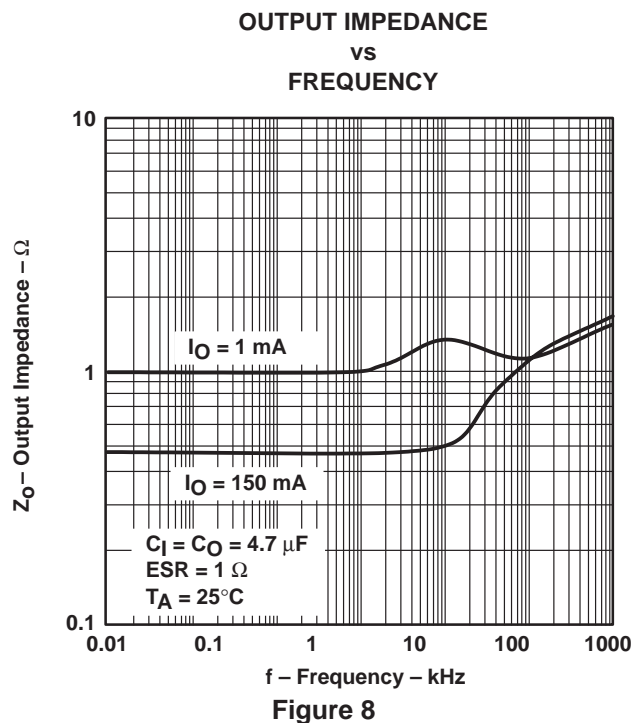
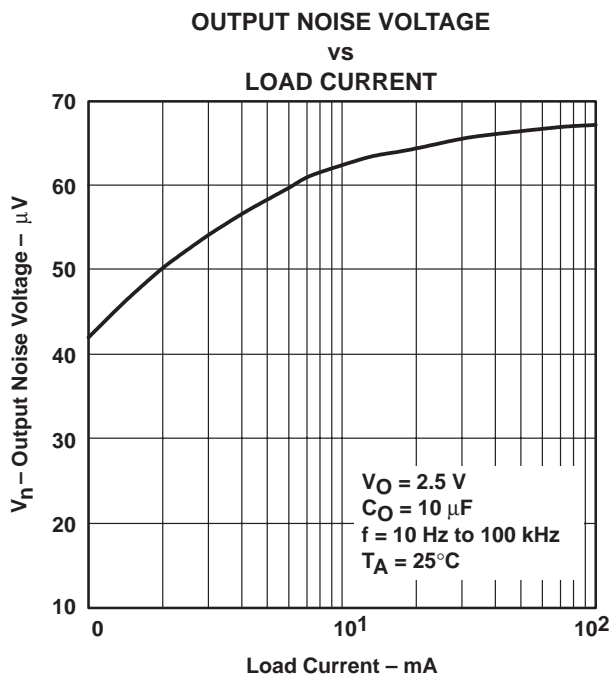

Figure 6

TPS76425, TPS76427, TPS76428, TPS76430, TPS76433 LOW-POWER LOW-NOISE 150-mA LOW-DROPOUT LINEAR REGULATORS

SLVS180A – MARCH 1999 – REVISED JUNE 1999

TYPICAL CHARACTERISTICS



TYPICAL CHARACTERISTICS

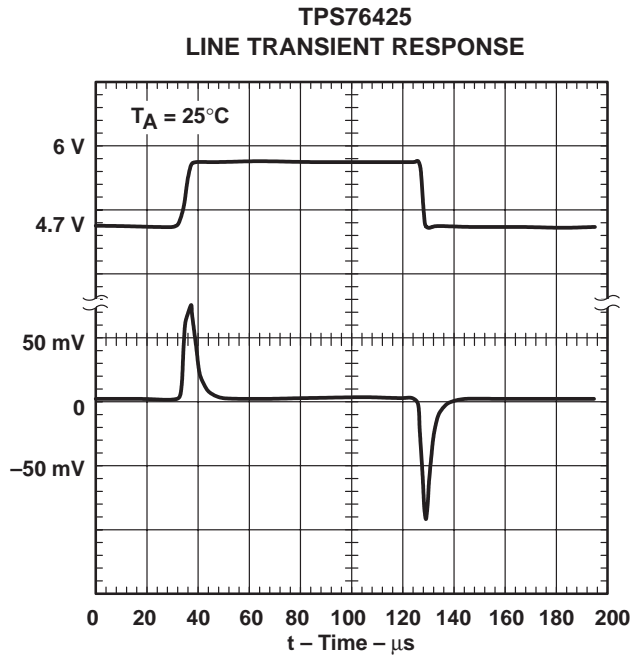

Figure 11

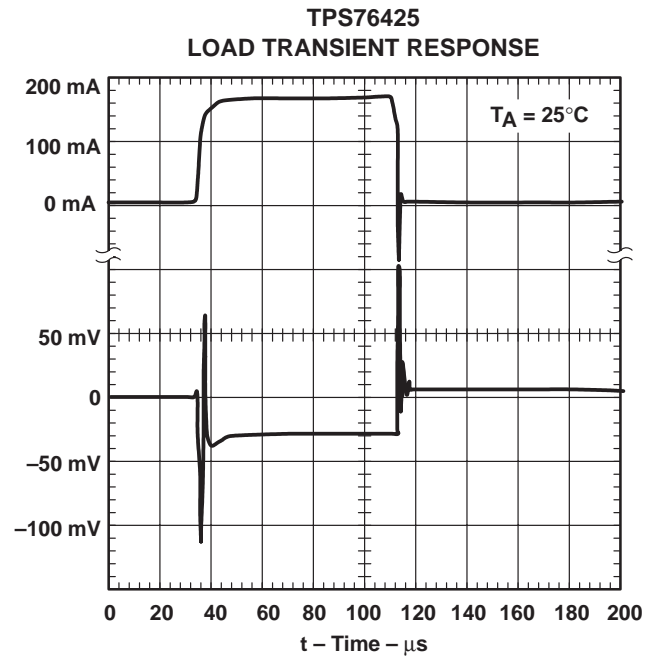

Figure 12

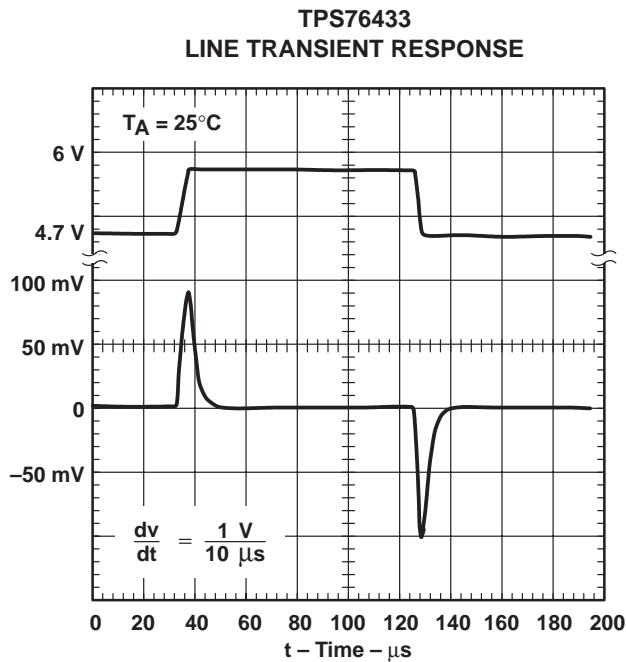

Figure 13

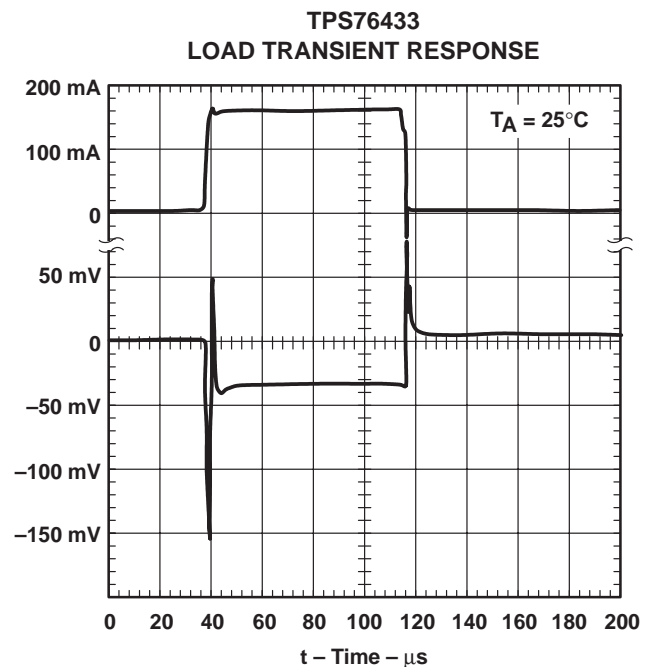

Figure 14

TPS76425, TPS76427, TPS76428, TPS76430, TPS76433 LOW-POWER LOW-NOISE 150-mA LOW-DROPOUT LINEAR REGULATORS

SLVS180A – MARCH 1999 – REVISED JUNE 1999

TYPICAL CHARACTERISTICS

TYPICAL REGIONS OF STABILITY
COMPENSATION SERIES RESISTANCE (CSR)[†]
VS
OUTPUT CURRENT

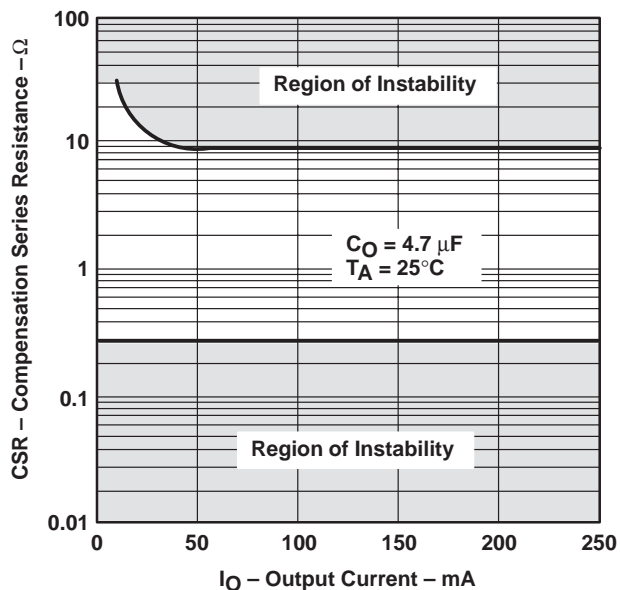

Figure 15

TYPICAL REGIONS OF STABILITY
COMPENSATION SERIES RESISTANCE (CSR)[†]
VS
ADDED CERAMIC CAPACITANCE

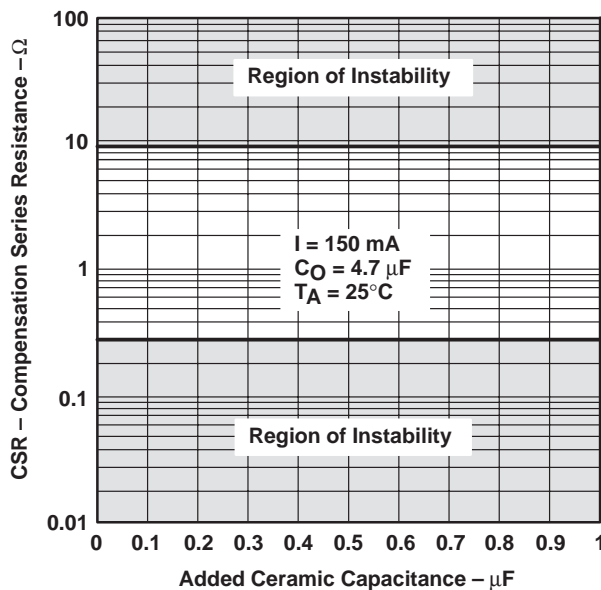

Figure 16

TYPICAL REGIONS OF STABILITY
COMPENSATION SERIES RESISTANCE (CSR)[†]
VS
OUTPUT CURRENT

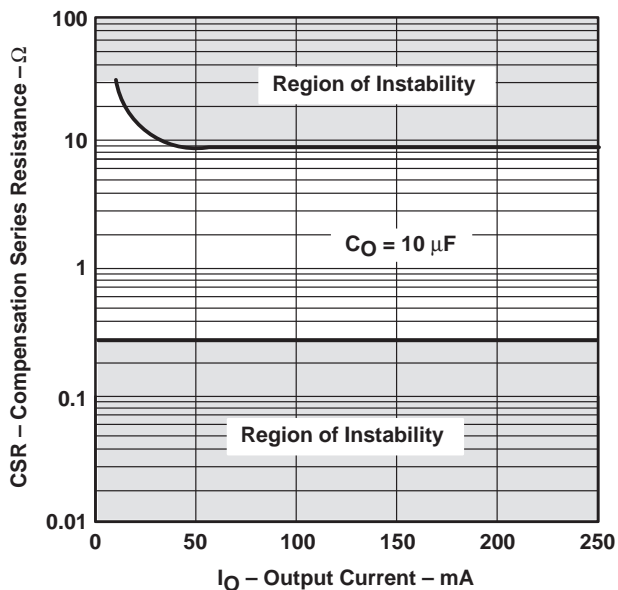

Figure 17

TYPICAL REGIONS OF STABILITY
COMPENSATION SERIES RESISTANCE (CSR)[†]
VS
ADDED CERAMIC CAPACITANCE

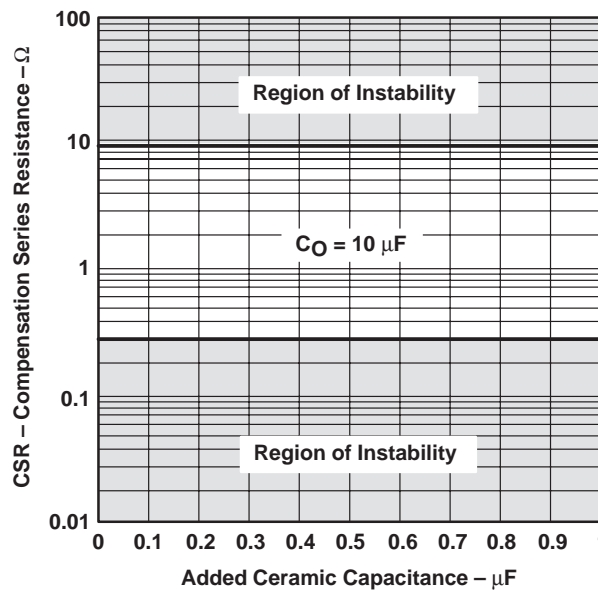

Figure 18

[†] CSR refers to the total series resistance, including the ESR of the capacitor, any series resistance added externally, and PWB trace resistance to C_O .

APPLICATION INFORMATION

The TPS764xx family of low-noise and low-dropout (LDO) regulators are optimized for use in battery-operated equipment. They feature extremely low noise (50 μV), low dropout voltages, low quiescent current (140 μA), and an enable input to reduce supply current to less than 2 μA when the regulator is turned off.

device operation

The TPS764xx uses a PMOS pass element to dramatically reduce both dropout voltage and supply current over more conventional PNP-pass-element LDO designs. The PMOS pass element is a voltage-controlled device which, unlike a PNP transistor, does not require increased drive current as output current increases. Supply current in the TPS764xx is essentially constant from no-load to maximum load.

Current limiting and thermal protection prevent damage by excessive output current and/or power dissipation. The device switches into a constant-current mode at approximately 1 A; further load reduces the output voltage instead of increasing the output current. The thermal protection shuts the regulator off if the junction temperature rises above 165°C. Recovery is automatic when the junction temperature drops approximately 25°C below the high temperature trip point. The PMOS pass element includes a back diode that safely conducts reverse current when the input voltage level drops below the output voltage level.

An internal resistor, in conjunction with external 0.01- μF bypass capacitor, creates a low-pass filter to further reduce the noise. The TPS764xx exhibits only 50 μV of output voltage noise using 0.01 μF bypass and 4.7- μF output capacitors.

A logic low on the enable input, EN, shuts off the output and reduces the supply current to less than 2 μA . EN should be tied high in applications where the shutdown feature is not used.

A typical application circuit is shown in Figure 22.

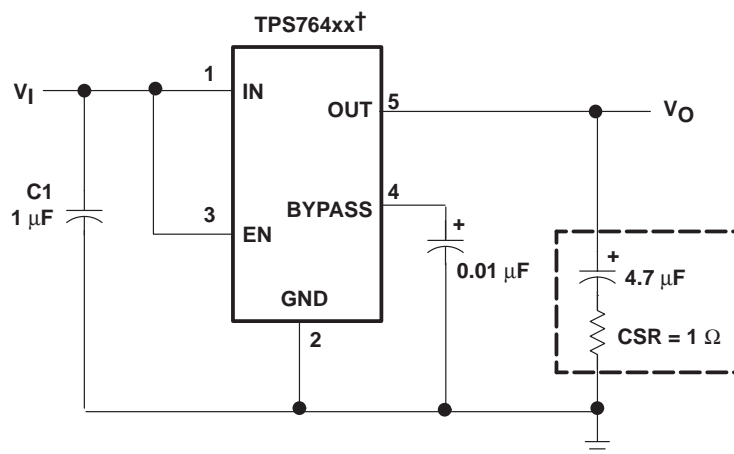

† TPS76425, TPS76427, TPS76430, TPS76433.

Figure 19. Typical Application Circuit

TPS76425, TPS76427, TPS76428, TPS76430, TPS76433 LOW-POWER LOW-NOISE 150-mA LOW-DROPOUT LINEAR REGULATORS

SLVS180A – MARCH 1999 – REVISED JUNE 1999

APPLICATION INFORMATION

external capacitor requirements

Although not required, a 0.047- μ F or larger ceramic bypass input capacitor, connected between IN and GND and located close to the TPS764xx, is recommended to improve transient response and noise rejection. A higher-value electrolytic input capacitor may be necessary if large, fast-rise-time load transients are anticipated and the device is located several inches from the power source.

Like all low dropout regulators, the TPS764xx requires an output capacitor connected between OUT and GND to stabilize the internal loop control. The minimum recommended capacitance value is 4.7 μ F and the ESR (equivalent series resistance) must be between 0.2 Ω and 10 Ω . Capacitor values 4.7 μ F or larger are acceptable, provided the ESR is less than 10 Ω . Solid tantalum electrolytic, aluminum electrolytic, and multilayer ceramic capacitors are all suitable, provided they meet the requirements described above. Most of the commercially available 4.7 μ F surface-mount solid tantalum capacitors, including devices from Sprague, Kemet, and Nichico, meet the ESR requirements previously stated. Multilayer ceramic capacitors should have minimum values of 1 μ F over the full operating temperature range of the equipment.

CAPACITOR SELECTION

PART NO.	MFR.	VALUE	MAX ESR†	SIZE (H × L × W)†
T494B475K016AS	KEMET	4.7 μ F	1.5 Ω	1.9 × 3.5 × 2.8
195D106x0016x2T	SPRAGUE	10 μ F	1.5 Ω	1.3 × 7.0 × 2.7
695D106x003562T	SPRAGUE	10 μ F	1.3 Ω	2.5 × 7.6 × 2.5
TPSC475K035R0600	AVX	4.7 μ F	0.6 Ω	2.6 × 6.0 × 3.2

† Size is in mm. ESR is maximum resistance in ohms at 100 kHz and $T_A = 25^\circ\text{C}$. Listings are sorted by height.



POST OFFICE BOX 655303 • DALLAS, TEXAS 75265

APPLICATION INFORMATION

power dissipation and junction temperature

Specified regulator operation is assured to a junction temperature of 125°C; the maximum junction temperature allowable without damaging the device is 150°C. This restriction limits the power dissipation the regulator can handle in any given application. To ensure the junction temperature is within acceptable limits, calculate the maximum allowable dissipation, $P_{D(max)}$, and the actual dissipation, P_D , which must be less than or equal to $P_{D(max)}$.

The maximum-power-dissipation limit is determined using the following equation:

$$P_{D(max)} = \frac{T_{Jmax} - T_A}{R_{\theta JA}}$$

Where

T_{Jmax} is the maximum allowable junction temperature

$R_{\theta JA}$ is the thermal resistance junction-to-ambient for the package, i.e., 285°C/W for the 5-terminal SOT23.

T_A is the ambient temperature.

The regulator dissipation is calculated using:

$$P_D = (V_I - V_O) \times I_O$$

Power dissipation resulting from quiescent current is negligible.

regulator protection

The TPS764xx pass element has a built-in back diode that safely conducts reverse current when the input voltage drops below the output voltage (e.g., during power down). Current is conducted from the output to the input and is not internally limited. If extended reverse voltage is anticipated, external limiting might be appropriate.

The TPS764xx also features internal current limiting and thermal protection. During normal operation, the TPS764xx limits output current to approximately 800 mA. When current limiting engages, the output voltage scales back linearly until the overcurrent condition ends. While current limiting is designed to prevent gross device failure, care should be taken not to exceed the power dissipation ratings of the package. If the temperature of the device exceeds 165°C, thermal-protection circuitry shuts it down. Once the device has cooled down to below 140°C, regulator operation resumes.

TPS76425, TPS76427, TPS76428, TPS76430, TPS76433
 LOW-POWER LOW-NOISE 150-mA LOW-DROPOUT LINEAR REGULATORS

SLVS180A – MARCH 1999 – REVISED JUNE 1999

MECHANICAL DATA

DBV (R-PDSO-G5)

PLASTIC SMALL-OUTLINE PACKAGE

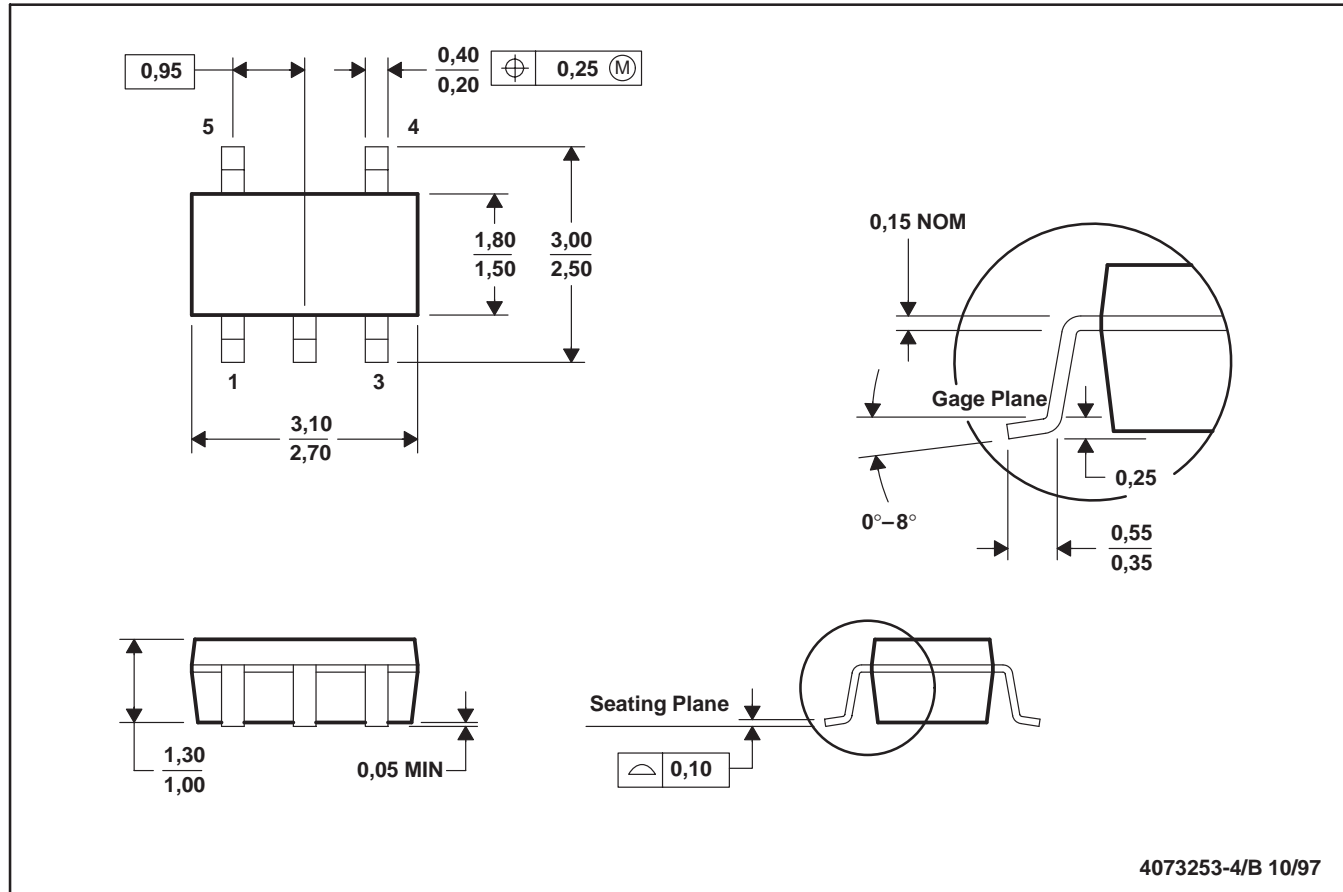

- NOTES: A. All linear dimensions are in millimeters.
 B. This drawing is subject to change without notice.
 C. Body dimensions include mold flash or protrusion.

IMPORTANT NOTICE

Texas Instruments and its subsidiaries (TI) reserve the right to make changes to their products or to discontinue any product or service without notice, and advise customers to obtain the latest version of relevant information to verify, before placing orders, that information being relied on is current and complete. All products are sold subject to the terms and conditions of sale supplied at the time of order acknowledgement, including those pertaining to warranty, patent infringement, and limitation of liability.

TI warrants performance of its semiconductor products to the specifications applicable at the time of sale in accordance with TI's standard warranty. Testing and other quality control techniques are utilized to the extent TI deems necessary to support this warranty. Specific testing of all parameters of each device is not necessarily performed, except those mandated by government requirements.

CERTAIN APPLICATIONS USING SEMICONDUCTOR PRODUCTS MAY INVOLVE POTENTIAL RISKS OF DEATH, PERSONAL INJURY, OR SEVERE PROPERTY OR ENVIRONMENTAL DAMAGE ("CRITICAL APPLICATIONS"). TI SEMICONDUCTOR PRODUCTS ARE NOT DESIGNED, AUTHORIZED, OR WARRANTED TO BE SUITABLE FOR USE IN LIFE-SUPPORT DEVICES OR SYSTEMS OR OTHER CRITICAL APPLICATIONS. INCLUSION OF TI PRODUCTS IN SUCH APPLICATIONS IS UNDERSTOOD TO BE FULLY AT THE CUSTOMER'S RISK.

In order to minimize risks associated with the customer's applications, adequate design and operating safeguards must be provided by the customer to minimize inherent or procedural hazards.

TI assumes no liability for applications assistance or customer product design. TI does not warrant or represent that any license, either express or implied, is granted under any patent right, copyright, mask work right, or other intellectual property right of TI covering or relating to any combination, machine, or process in which such semiconductor products or services might be or are used. TI's publication of information regarding any third party's products or services does not constitute TI's approval, warranty or endorsement thereof.