

# Data sheet | Item number: 2616-1106/020-000

PCB terminal block; lever; 16 mm<sup>2</sup>; Pin spacing 10 mm; 6-pole; Push-in CAGE CLAMP®; 16,00 mm<sup>2</sup>; gray

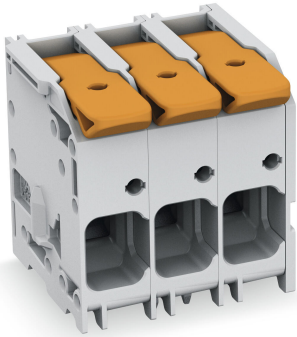

[www.wago.com/2616-1106/020-000](http://www.wago.com/2616-1106/020-000)



**i** Picture differs from the item.

RoHS  Compliant

BOMcheck.net

Color:

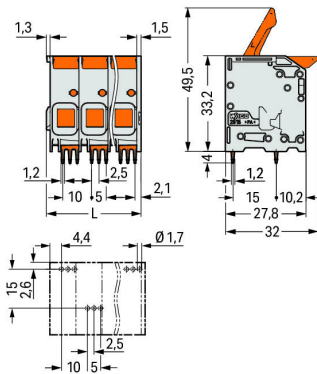
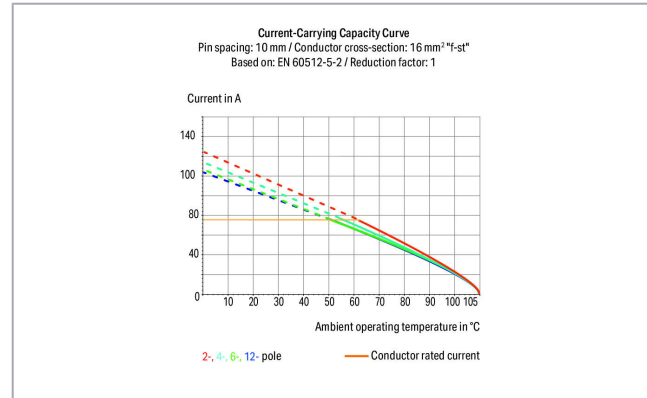

$$L = (\text{pole no.} - 1) \times \text{pin spacing} + 12.8 \text{ mm}$$

## Item description

- PCB terminal blocks with levers and Push-in CAGE CLAMP® connection
- Push-in termination of solid and ferruled conductors
- Intuitive and tool-free operation

Subject to changes. Please also observe the further product documentation!

WAGO Kontakttechnik GmbH & Co. KG  
Hansastr. 27  
32423 Minden  
Phone: +49571 887-0 | Fax: +49571 887-169  
Email: [info.de@wago.com](mailto:info.de@wago.com) | Web: [www.wago.com](http://www.wago.com)

Do you have any questions about our products?  
We are always happy to take your call at +49 (571) 887-44222.



- Several clamping units can be held open simultaneously – convenient for terminating multi-core cables
- Testing can be performed both parallel and perpendicular to conductor entry

## Data

### Electrical data

#### Ratings per IEC/EN

Ratings per	IEC/EN 60664-1
Nominal voltage (III/3)	1000 V
Rated surge voltage (III/3)	8 kV
Rated voltage (III/2)	1000 V
Rated surge voltage (III/2)	8 kV
Nominal voltage (II/2)	1000 V
Rated surge voltage (II/2)	8 kV
Rated current	76 A
Legend (ratings)	(III / 2) $\hat{=}$ Overvoltage category III / Pollution degree 2

#### Ratings per UL

Approvals per	UL 1059
Rated voltage UL (Use Group B)	600 V
Rated current UL (Use Group B)	66 A
Rated voltage UL (Use Group C)	600 V
Rated current UL (Use Group C)	66 A

#### Ratings per CSA

Approvals per	CSA
Rated voltage CSA (Use Group B)	600 V
Rated current CSA (Use Group B)	66 A
Rated voltage CSA (Use Group C)	600 V
Rated current CSA (Use Group C)	66 A

### Connection data

Connection technology	Push-in CAGE CLAMP®
Actuation type	Lever
Solid conductor	0.75 ... 16 mm <sup>2</sup> / 18 ... 4 AWG
Fine-stranded conductor	0.75 ... 25 mm <sup>2</sup> / 18 ... 4 AWG

Subject to changes. Please also observe the further product documentation!



Fine-stranded conductor; with insulated ferrule	0.75 ... 16 mm <sup>2</sup>
Fine-stranded conductor; with uninsulated ferrule	0.75 ... 16 mm <sup>2</sup>
Fine-stranded conductor; with twin ferrule	0.75 ... 6 mm <sup>2</sup>
Strip length	18 ... 20 mm / 0.71 ... 0.79 inch
Conductor connection direction to PCB	0°
Pole No.	6
Total number of connection points	6
Total number of potentials	6
Number of connection types	1
Number of levels	1

### Physical data

Pin spacing	10 mm / 0.394 inch
Width	62.8 mm / 2.472 inch
Height	37.2 mm / 1.465 inch
Height from the surface	33.2 mm / 1.307 inch
Depth	32 mm / 1.26 inch
Solder pin length	4 mm
Solder pin dimensions	1.2 x 1.2 mm
Drilled hole diameter with tolerance	1.7 (+0.1) mm

### PCB contact

PCB Contact	THT
Solder pin arrangement	over the entire terminal strip (staggered)
Number of solder pins per potential	3

### Material data

Color	gray
Material group	I
Insulation material	Polyamide (PA66)
Flammability class per UL94	V0
Clamping spring material	Chrome nickel spring steel (CrNi)
Contact material	Electrolytic copper (E <sub>Cu</sub> )
Contact plating	tin-plated
Fire load	0.57 MJ
Color of actuator	orange

Subject to changes. Please also observe the further product documentation!

Weight	56 g
--------	------

### Environmental requirements



Limit temperature range	-60 ... +105 °C
-------------------------	-----------------

### Commercial data

Packaging type	BOX
Country of origin	PL
GTIN	4055143707411
Customs tariff number	85369010000

### Approvals / Certificates

#### Country specific Approvals

Logo	Approval	Additional Approval Text	Certificate name
	<b>CB</b> DEKRA Certification B.V.	EN 60947-7-4	NL-61617
	<b>CSA</b> DEKRA Certification B.V.	C22.2	70154737
	<b>KEMA/KEUR</b> DEKRA Certification B.V.	EN 60947-7-4	71-110774

#### UL-Approvals

Logo	Approval	Additional Approval Text	Certificate name
	<b>cULus</b> Underwriters Laboratories Inc.	C22.2 No. 158	E45172

### Compatible products





#### ferrule



Item no.: 216-210

Ferrule; Sleeve for 16 mm<sup>2</sup> / AWG 6; insulated; electro-tin plated; electrolytic copper; gastight crimped; [www.wago.com/216-210](http://www.wago.com/216-210)  
acc. to DIN 46228, Part 4/09.90; blue

Subject to changes. Please also observe the further product documentation!

	<p><b>Item no.: 216-284</b>                  Ferrule; Sleeve for 1.5 mm<sup>2</sup> / AWG 16; insulated; electro-tin plated; electrolytic copper; gastight crimped; acc. to DIN 46228, Part 4/09.90; black</p>	<a href="http://www.wago.com/216-284">www.wago.com/216-284</a>
	<p><b>Item no.: 216-286</b>                  Ferrule; Sleeve for 2.5 mm<sup>2</sup> / AWG 14; insulated; electro-tin plated; electrolytic copper; gastight crimped; acc. to DIN 46228, Part 4/09.90; blue</p>	<a href="http://www.wago.com/216-286">www.wago.com/216-286</a>
	<p><b>Item no.: 216-287</b>                  Ferrule; Sleeve for 4 mm<sup>2</sup> / AWG 12; insulated; electro-tin plated; electrolytic copper; gastight crimped; acc. to DIN 46228, Part 4/09.90; gray</p>	<a href="http://www.wago.com/216-287">www.wago.com/216-287</a>
	<p><b>Item no.: 216-288</b>                  Ferrule; Sleeve for 6 mm<sup>2</sup> / AWG 10; insulated; electro-tin plated; electrolytic copper; gastight crimped; acc. to DIN 46228, Part 4/09.90; yellow</p>	<a href="http://www.wago.com/216-288">www.wago.com/216-288</a>
	<p><b>Item no.: 216-289</b>                  Ferrule; Sleeve for 10 mm<sup>2</sup> / AWG 8; insulated; electro-tin plated; electrolytic copper; gastight crimped; acc. to DIN 46228, Part 4/09.90; red</p>	<a href="http://www.wago.com/216-289">www.wago.com/216-289</a>

## Downloads

### Documentation

#### Additional Information

Technical explanations	3. 4. 2019	pdf 2.0 MB	Download
------------------------	------------	---------------	----------

## CAD/CAE-Data

### CAD data

2D/3D Models 2616-1106/020-000	URL	Download
--------------------------------	-----	----------

### PCB Design

Symbol and Footprint 2616-1106/020-000	URL	Download
--	-----	----------

CAX data for your PCB design, consisting of "schematic symbols and PCB footprints", allow easy integration of the WAGO component into your development environment.

### Supported formats:

- Accel EDA 14 & 15
- Altium 6 to current version
- Cadence Allegro
- DesignSpark
- Eagle Libraries
- KiCad
- Mentor Graphics BoardStation

—  
Subject to changes. Please also observe the further product documentation!



- Mentor Graphics Design Architect
- Mentor Graphics Design Expedition 99 and 2000
- OrCAD 9.X PCB and Capture
- PADS PowerPCB 3, 3.5, 4.X, and 5.X
- PADS PowerPCB and PowerLogic 3.0
- PCAD 2000, 2001, 2002, 2004, and 2006
- Pulsonix 8.5 or newer
- STL
- 3D STEP
- TARGET 3001!
- View Logic ViewDraw
- Quadcept
- Zuken CadStar 3 and 4
- Zuken CR-5000 and CR-8000

PCB Component Libraries (EDA), PCB CAD Library Ultra Librarian

---

#### CAE data

ZUKEN Portal 2616-1106/020-000	<a href="#">URL</a>	<a href="#">Download</a>
--------------------------------	---------------------	--------------------------

---

#### Environmental Product Compliance

##### Compliance Search

Environmental Product Compliance 2616-1106/020-000 PCB terminal block; lever; 16 mm <sup>2</sup> ; Pin spacing 10 mm; 6-pole; Push-in CAGE CLAMP®; 16,00 mm <sup>2</sup> ; gray	<a href="#">URL</a>	<a href="#">Download</a>
--	---------------------	--------------------------

---

#### Installation Notes

Subject to changes. Please also observe the further product documentation!