

Silizium-PIN-Fotodiode mit sehr kurzer Schaltzeit Silicon PIN Photodiode with Very Short Switching Time

SFH 203
SFH 203 FA



SFH 203



SFH 203 FA

Wesentliche Merkmale

- Speziell geeignet für Anwendungen im Bereich von 400 nm bis 1100 nm (SFH 203) und bei 880 nm (SFH 203 FA)
- Kurze Schaltzeit (typ. 5 ns)
- 5 mm-Plastikbauform im LED-Gehäuse
- Auch gegurtet lieferbar

Anwendungen

- Industrieelektronik
- „Messen/Steuern/Regeln“
- Schnelle Lichtschranken für Gleich- und Wechsellichtbetrieb
- LWL

Features

- Especially suitable for applications from 400 nm to 1100 nm (SFH 203) and of 880 nm (SFH 203 FA)
- Short switching time (typ. 5 ns)
- 5 mm LED plastic package
- Also available on tape and reel

Applications

- Industrial electronics
- For control and drive circuits
- Photointerrupters
- Fiber optic transmission systems

| Typ Type | Bestellnummer Ordering Code |
|-------------|--------------------------------|
| SFH 203 | Q62702-P955 |
| SFH 203 FA | Q62702-P956 |

Grenzwerte
Maximum Ratings

| Bezeichnung Parameter | Symbol Symbol | Wert Value | Einheit Unit |
|---|-------------------|----------------|-----------------|
| Betriebs- und Lagertemperatur Operating and storage temperature range | $T_{op}; T_{stg}$ | - 40 ... + 100 | °C |
| Löttemperatur (Lötstelle 2 mm vom Gehäuse entfernt bei Lötzeit $t \leq 3$ s) Soldering temperature in 2 mm distance from case bottom ($t \leq 3$ s) | T_S | 230 | °C |
| Sperrspannung Reverse voltage | V_R | 50 | V |
| Verlustleistung Total power dissipation | P_{tot} | 100 | mW |

Kennwerte ($T_A = 25$ °C)
Characteristics

| Bezeichnung Parameter | Symbol Symbol | Wert Value | | Einheit Unit |
|---|------------------------------|------------------|------------------|-----------------|
| | | SFH 203 | SFH 203 FA | |
| Fotostrom Photocurrent $V_R = 5$ V, Normlicht/standard light A, $T = 2856$ K, $E_V = 1000$ lx $V_R = 5$ V, $\lambda = 950$ nm, $E_e = 1$ mW/cm ² | I_P | 80 (≥ 50) | – | μ A |
| | I_P | – | 50 (≥ 30) | μ A |
| Wellenlänge der max. Fotoempfindlichkeit Wavelength of max. sensitivity | $\lambda_{S\ max}$ | 850 | 900 | nm |
| Spektraler Bereich der Fotoempfindlichkeit $S = 10\%$ von S_{max} Spectral range of sensitivity $S = 10\%$ of S_{max} | λ | 400 ... 1100 | 800 ... 1100 | nm |
| Bestrahlungsempfindliche Fläche Radiant sensitive area | A | 1 | 1 | mm ² |
| Abmessung der bestrahlungsempfindlichen Fläche Dimensions of radiant sensitive area | $L \times B$ $L \times W$ | 1 × 1 | 1 × 1 | mm × mm |
| Abstand Chipoberfläche zu Gehäuseoberfläche Distance chip front to case surface | H | 4.0 ... 4.6 | 4.0 ... 4.6 | mm |
| Halbwinkel Half angle | φ | ± 20 | ± 20 | Grad deg. |

Kennwerte ($T_A = 25\text{ °C}$)
Characteristics (cont'd)

| Bezeichnung Parameter | Symbol Symbol | Wert Value | | Einheit Unit |
|---|--------------------------|-------------------------|-------------------------|--|
| | | SFH 203 | SFH 203 FA | |
| Dunkelstrom, $V_R = 20\text{ V}$ Dark current | I_R | 1 (≤ 5) | 1 (≤ 5) | nA |
| Spektrale Fotoempfindlichkeit, $\lambda = 850\text{ nm}$ Spectral sensitivity | S_λ | 0.62 | 0.59 | A/W |
| Quantenausbeute, $\lambda = 850\text{ nm}$ Quantum yield | η | 0.89 | 0.86 | <u>Electrons</u> Photon |
| Leerlaufspannung Open-circuit voltage $E_v = 1000\text{ lx}$, Normlicht/standard light A, $T = 2856\text{ K}$ $E_e = 0.5\text{ mW/cm}^2$, $\lambda = 950\text{ nm}$ | V_O V_O | 420 (≥ 350) – | – 370 (≥ 300) | mV mV |
| Kurzschlußstrom Short-circuit current $E_v = 1000\text{ lx}$, Normlicht/standard light A, $T = 2856\text{ K}$ $E_e = 0.5\text{ mW/cm}^2$, $\lambda = 950\text{ nm}$ | I_{SC} I_{SC} | 80 – | – 25 | μA μA |
| Anstiegs- und Abfallzeit des Fotostromes Rise and fall time of the photocurrent $R_L = 50\ \Omega$; $V_R = 20\text{ V}$; $\lambda = 850\text{ nm}$; $I_p = 800\ \mu\text{A}$ | t_r, t_f | 5 | 5 | ns |
| Durchlaßspannung, $I_F = 80\text{ mA}$, $E = 0$ Forward voltage | V_F | 1.3 | 1.3 | V |
| Kapazität, $V_R = 0\text{ V}$, $f = 1\text{ MHz}$, $E = 0$ Capacitance | C_0 | 11 | 11 | pF |
| Temperaturkoeffizient von V_O Temperature coefficient of V_O | TC_V | – 2.6 | – 2.6 | mV/K |
| Temperaturkoeffizient von I_{SC} Temperature coefficient of I_{SC} Normlicht/standard light A $\lambda = 950\text{ nm}$ | TC_I | 0.18 – | – 0.2 | %/K |
| Rauschäquivalente Strahlungsleistung Noise equivalent power $V_R = 20\text{ V}$, $\lambda = 850\text{ nm}$ | NEP | 2.9×10^{-14} | 2.9×10^{-14} | $\frac{\text{W}}{\sqrt{\text{Hz}}}$ |
| Nachweisgrenze, $V_R = 20\text{ V}$, $\lambda = 850\text{ nm}$ Detection limit | D^* | 3.5×10^{12} | 3.5×10^{12} | $\frac{\text{cm} \times \sqrt{\text{Hz}}}{\text{W}}$ |

Relative Spectral Sensitivity SFH 203

$S_{rel} = f(\lambda)$

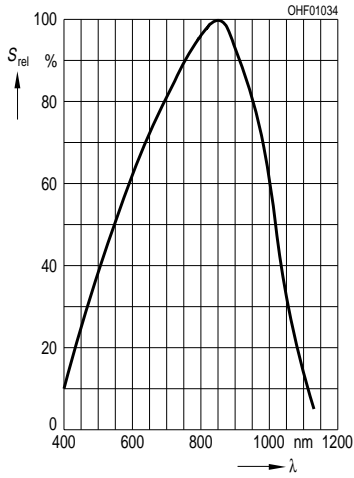

Relative Spectral Sensitivity SFH 203 FA

$S_{rel} = f(\lambda)$

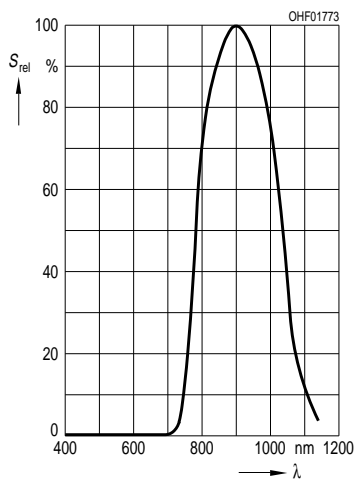

**Photocurrent $I_P = f(E_V)$, $V_R = 5 V$
Open-Circuit Voltage $V_O = f(E_V)$
SFH 203**

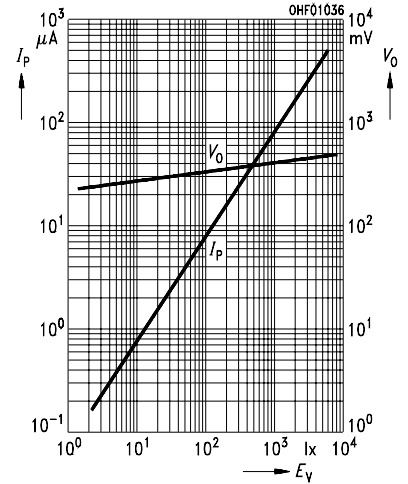

**Photocurrent $I_P = f(E_e)$, $V_R = 5 V$
Open-Circuit-Voltage $V_O = f(E_e)$
SFH 203 FA**

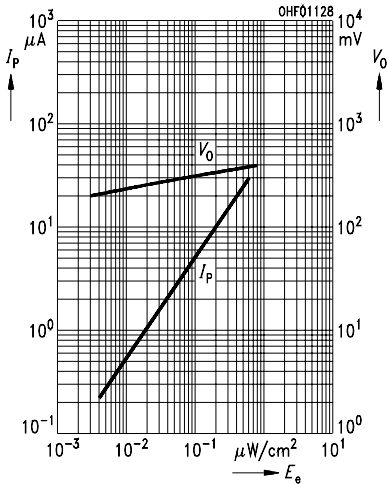

Total Power Dissipation $P_{tot} = f(T_A)$

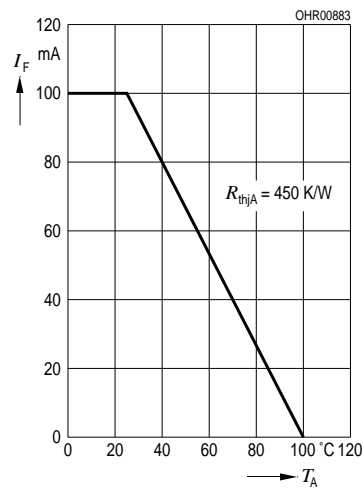

Dark Current $I_R = f(V_R)$, $E = 0$

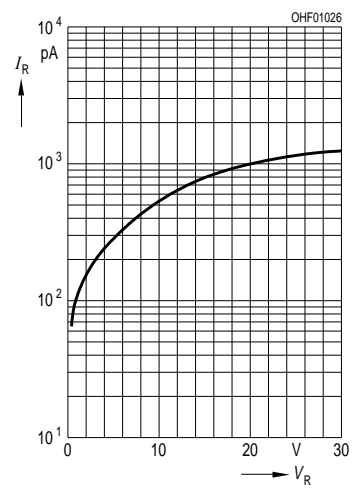

Directional Characteristics

$S_{rel} = f(\varphi)$

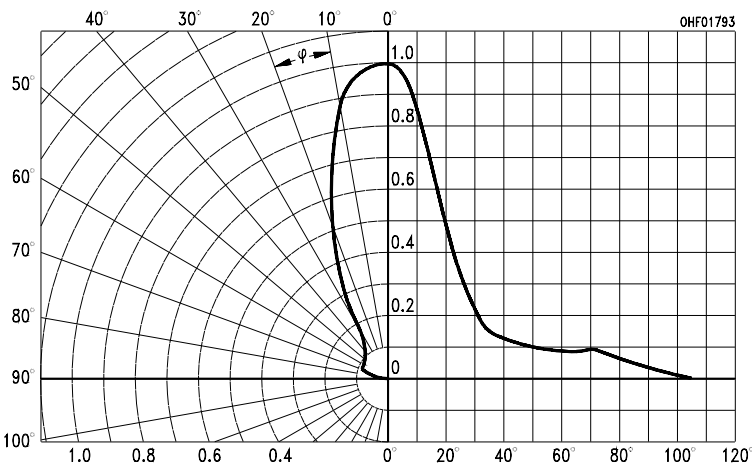

Maßzeichnung Package Outlines

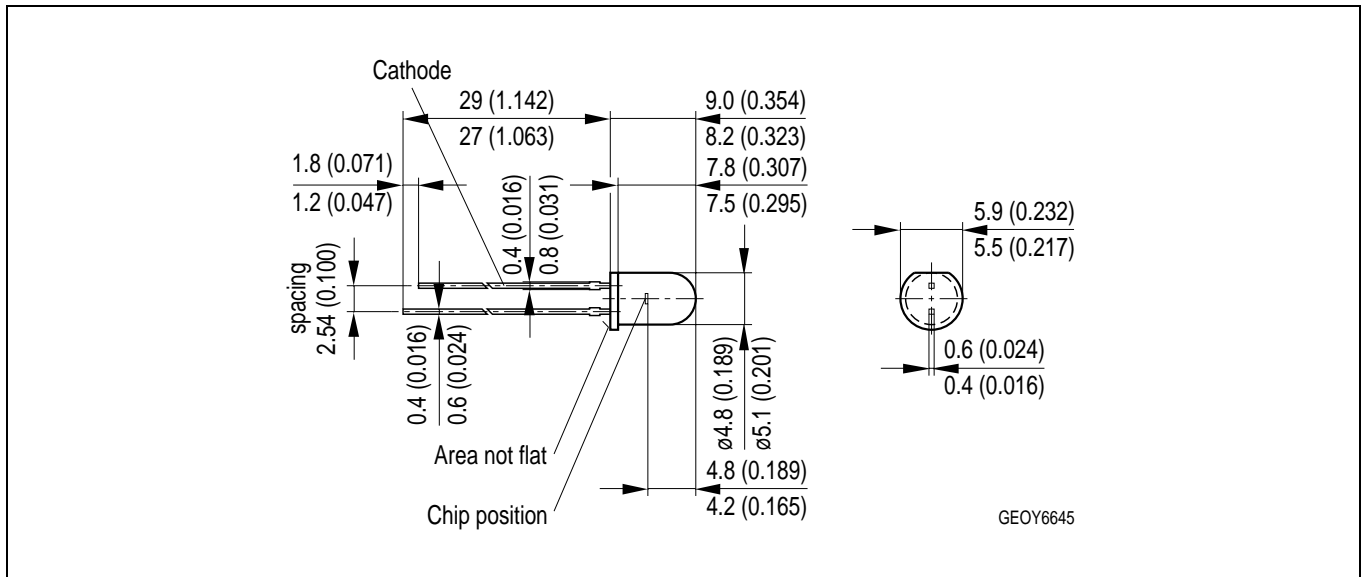

Maße werden wie folgt angegeben: mm (inch) / Dimensions are specified as follows: mm (inch).

Published by OSRAM Opto Semiconductors GmbH & Co. OHG
Wernerwerkstrasse 2, D-93049 Regensburg

© All Rights Reserved.

Attention please!

The information describes the type of component and shall not be considered as assured characteristics. Terms of delivery and rights to change design reserved. Due to technical requirements components may contain dangerous substances. For information on the types in question please contact our Sales Organization.

Packing

Please use the recycling operators known to you. We can also help you – get in touch with your nearest sales office. By agreement we will take packing material back, if it is sorted. You must bear the costs of transport. For packing material that is returned to us unsorted or which we are not obliged to accept, we shall have to invoice you for any costs incurred.

Components used in life-support devices or systems must be expressly authorized for such purpose! Critical components ¹ may only be used in life-support devices or systems ² with the express written approval of OSRAM OS.

¹ A critical component is a component used in a life-support device or system whose failure can reasonably be expected to cause the failure of that life-support device or system, or to affect its safety or effectiveness of that device or system.

² Life support devices or systems are intended (a) to be implanted in the human body, or (b) to support and/or maintain and sustain human life. If they fail, it is reasonable to assume that the health of the user may be endangered.