

Display Elektronik GmbH

DATA SHEET

TFT- MODULE

DEM 800600E TMH-PW-N

10,4" TFT

15.05.2012

Revise Records

Rev.	Date	Contents	Written	Approved
0	15.05.2012	Preliminary Specification	MH	

Special Notes

Note1.	
Note2.	
Note3.	
Note4.	
Note5.	

Contents

1.	General Description and Features	4
1.1	Features	4
1.2	LCD Module	4
2.	Mechanical Information	4
3.	Electrical Specifications	5
3.1	Absolute Max. Ratings	5
3.2	Power on/off sequence	7
3.3	AC Timing Characteristic of The LCD	8
3.4	Back-Light Unit	10
4.	Optical Characteristics	11
4.1	Optical characteristic of the LCD	11
5.	I/O Terminal	13
5.1	Pin Assignment	13
5.2	Back Light Unit	14
5.3	Block Diagram	15
6.	Displayed Color and Input Data	16
7.	Reliability Condition	17
8.	Dimensional Outlines	18
9.	Incoming Inspection Standards	19

1. General Description and Features

DEM 800600E TMH-PW-N is a transmissive type color active matrix TFT (Thin Film Transistor) liquid crystal display (LCD) that uses amorphous silicon TFT as a switching device. This model is composed of a TFT-LCD module and a back-light unit. Graphics and texts can be displayed on a SVGA 800 (W) x RGB x 600 (H) dots (4:3 aspect ratio) with 16.2M colors by supplying 24 bits data signal (8bits/each color). The following table described the features of DEM 800600E TMH-PW-N.

1.1 Features

- 10,4" TFT
- Transmissive and LED Backlight with 42 LEDs.
- TN (Twisted Nematic) mode.
- ROHS Compliance

1.2 LCD Module

Item	Specification	Unit
Screen Size	10.4 inches	Diagonal
Display Resolution	800 (H) x 600 (V)	Pixel
Active Area	211.2 (H) x 158.4 (V)	mm
Outline Dimension	243 (H) x 185.6 (V) x 7.3 (T)	mm
Display Mode	Normally white mode/ Transmissive	--
Pixel Arrangement	R,G,B Vertical Stripe	--
Pixel Size	0.264 x 0.264	mm
Surface Treatment	Anti-Glare and Hard Coating(3H)	
Display Color	16.2M	--
Viewing Direction	6 o'clock	--
Input Interface	Digital 24 bit RGB (8bits/each color) Data Transfer	--

2. Mechanical Information

Item		Min.	Typ.	Max.	Unit	Note
Module Size	Horizontal (H)	--	243	--	mm	
	Vertical (V)	--	185.6	--	mm	
	Thickness (T)	--	7.3	--	mm	(1)
Weight		--	(TBD)	--	g	--

Note (1) Not Include Component. Refer to the Outline Dimension Drawing as attached.

3. Electrical Specifications

3.1 Absolute Max. Ratings

3.1.1 Absolute Ratings of Environment

If the operating condition exceeds the following absolute maximum ratings, the TFT LCD module may be damaged permanently.

($T_a=25\pm 2^\circ\text{C}$, $V_{SS}=\text{GND}=0$)

Item	Symbol	Min.	Max.	Unit	Note
Storage temperature	T_{STG}	-30	80	$^\circ\text{C}$	(1)
Operating temperature	T_{OPR}	-20	70	$^\circ\text{C}$	(1,2,3)

Note (1) 95 % RH Max. ($40^\circ\text{C} \geq T_a$). Maximum wet-bulb temperature at 39°C or less. ($T_a > 40^\circ\text{C}$) No condensation.

Note (2) In case of below 0° , the response time of liquid crystal (LC) becomes slower and the color of panel becomes darker than normal one. Level of retardation depends on temperature, because of LC's character

Note (3) Only operation is guaranteed at operating temperature. Contrast, response time, another display quality are evaluated at $+25^\circ\text{C}$.

3.1.2 Electrical Absolute Maximum Ratings

3.1.2.1 TFT-LCD Module

($\text{GND}=0$)

Parameter	Symbol	Min.	Max.	Unit	Remark
Power supply voltage	VCC	-0.3	5.0	V	(1)
Analog Power Supply Voltage	AVDD	-0.5	15	V	(1)
TFT Device on voltage	VGH	-0.3	42	V	(1)
TFT Device off voltage	VGL	VGH-42	0.3	V	(1)

(1) Device is subject to be damaged permanently if stresses beyond those absolute maximum ratings listed above.

3.1.2.2 Backlight Unit

($V_{SS}=\text{GND}=0$)

Parameter	Symbol	Min.	Max.	Unit	Remark
Current of Backlight Unit	IB	--	175	mA	
Voltage of Backlight Unit	VB	--	21	V	

3.1.3 DC Electrical Characteristics of the TFT LCD

(Ta=25±2°C, GND=0)

Item	Symbol	Min.	Typ.	Max.	Unit	Remark	
Digital Power supply	VCC	3.0	3.3	3.6	V		
Analog Power Supply Voltage	AVDD	10.3	10.5	10.7	V		
TFT Device on voltage	VGH	-	18	-	V		
TFT Device off voltage	VGL	-	-7	-	V		
Common Electrode Driving Voltage	VCOM	-	4.45	-	V	Note 1	
Input Voltage for logic	H Level	VIH	0.7xVCC	-	VCC	V	
	L Level	VIL	0	-	0.3xVCC	V	
Digital Power Supply current	ICC	24	30	45	mA	Note 2	
Analog Supply Current	I _{AVDD}	32	40	60	mA	Note 2	

Note1: VCOM must be adjusted to optimize display quality: cross-talk, contrast ratio and etc.

Note2: fv =60Hz , Ta=25°C , Display pattern : Black pattern

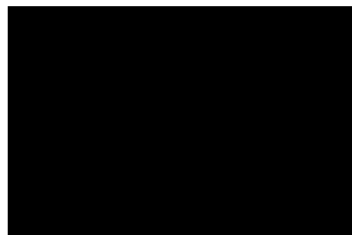

3.2 Power on/off sequence

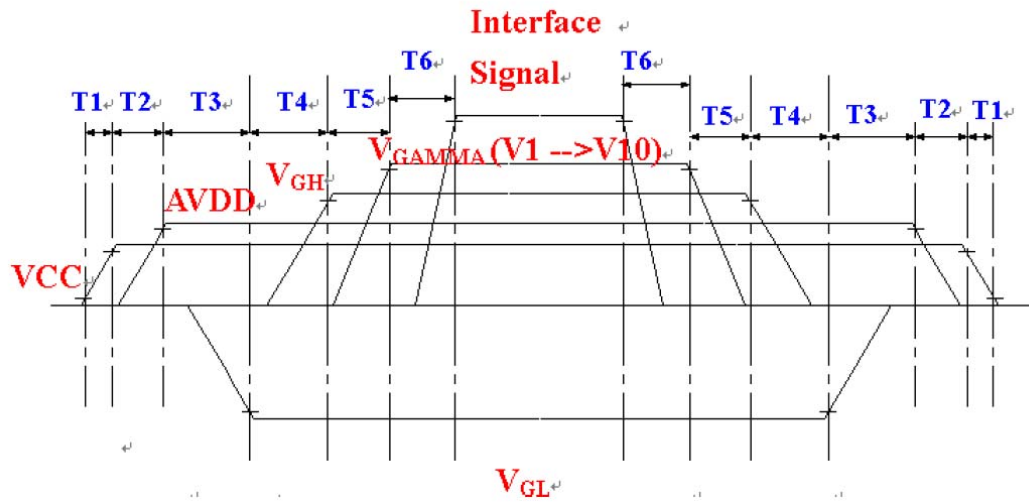

	Min.	Typ.	Max.	Unit
T1	-	-	20	ms
T2	16	-	-	ms
T3	> 0			ms
T4	>0			ms
T5	>0			ms
T6	>0			ms

3.3 AC Timing Characteristic of The LCD

3.3.1 Timing Condition

Signal	Parameter	Symbol	Min.	Typ.	Max.	Unit.	Remark
DCLK	CLK frequency	fclk	-	40	50	MHz	
	CLK period	tclk	20	25	-	ns	
	CLK pulse duty	tcwh	40	50	60	%	
Horizontal Timing	One Horizontal Line	th	862	1056	1200	DCLK	
	Horizontal Display Area	thd	-	800	-	DCLK	
	HS pulse width	thpw	1	-	40	DCLK	
	HS Back Porch	thb	46	46	46	DCLK	blanking
	HS Front Porch	thfp	16	210	354	DCLK	
Vertical Timing	VS period time	tv	624	635	700	TH	
	Vertical Display Area	tvd	-	600	-	TH	
	VS pulse width	tvpw	1	-	20	TH	
	VS Back Porch	tvb	23	23	23	TH	blanking
	VS Front Porch	tvfp	1	12	77	TH	

3.3.2 Timing Characteristic

3.3.2.1 Horizontal Timing

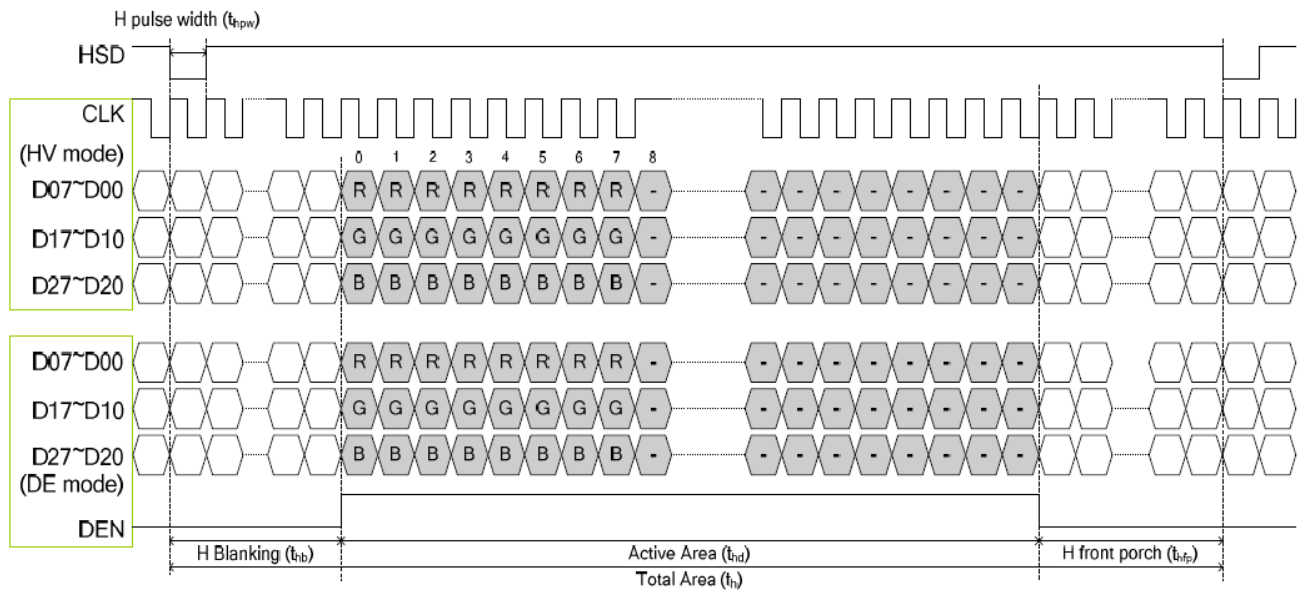

3.3.2.2 Vertical Timing

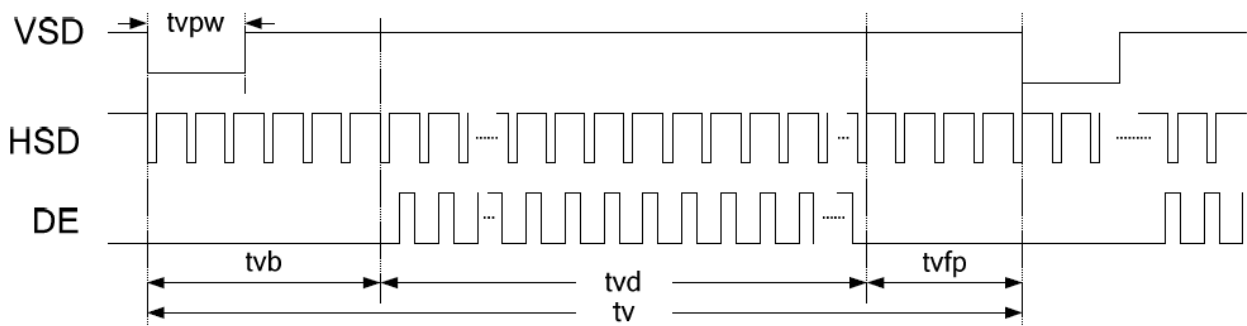

3.3.3 Clock and Data input waveforms

Parameter	Symbol	Min.	Typ.	Max.	Unit.	Remark
HS setup time	Thst	8	-	-	ns	
HS hold time	Thhd	8	-	-	ns	
VS setup time	Tvst	8	-	-	ns	
VS hold time	Tvhd	8	-	-	ns	
Data setup time	Tdsu	8	-	-	ns	
Data hold time	Tdhd	8	-	-	ns	
DE setup time	Tesu	8	-	-	ns	
DE hold time	Tehd	8	-	-	ns	
CLKIN cycle time	Tcph	20			ns	

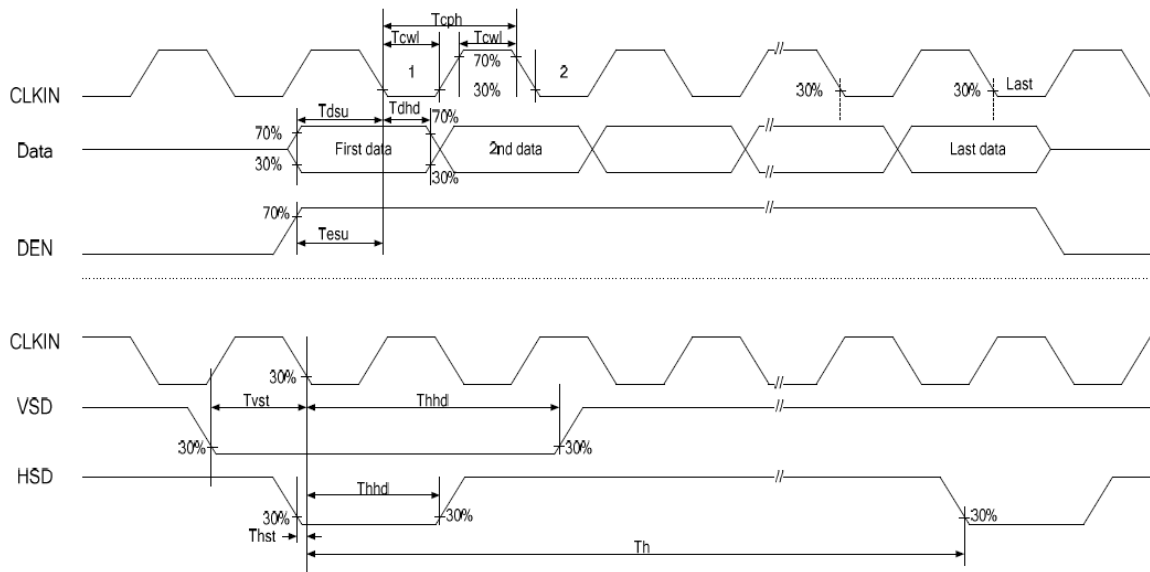

3.4 LED Backlight Unit

The Backlight system is an edge-lighting type with 42 white LED (Light Emitting Diode)s.

(Ta= 25±2°C)

Characteristics	Symbol	Min.	Typ.	Max.	Unit	Note
Forward Voltage	VB	(17.4)	(19.2)	(21)	V	
Forward Current	IB	-	140	175	mA	(1)
Power Consumption	P _{BL}	-	2688	3675	mW	(2)
LED Life time	-	(40000)	-	-	hr	(3)

Note (1) LEDs in 6 series x 7 parallel type.

(2) Where IB =140mA, VB = 19.2, P_{BL} = VB × IB

(3) The environmental conducted under ambient air flow ,at Ta=25±2°C, 60%RH±5%

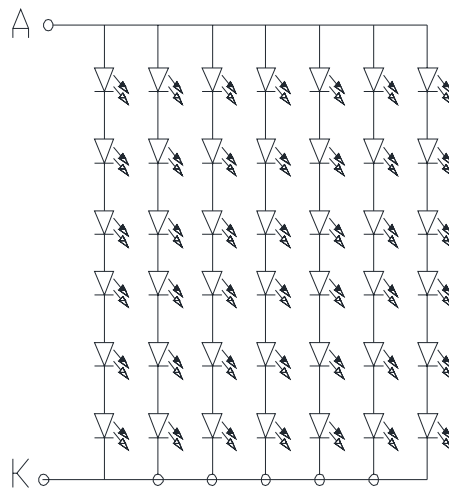

4. Optical Characteristics

4.1 Optical characteristic of the LCD

The following items are measured under stable conditions. The optical characteristics should be measured in a dark room or equivalent state with the methods.

Measuring equipment: BM-7A

Item	Symbol	Condition	Min	Type	Max	Unit	Note	
Brightness	B		(400)	(500)	--	cd/m ²		
Response time	T _r	θ=0°	-	5	10	ms	.	
	T _f		--	15	20	ms		
Contrast ratio	CR	At optimized viewing angle	(300)	(500)	--	--		
Luminance Uniformity	ΔL		70	75		%		
Color Chromaticity (CIE 1931)	White	W _x	θ=0° Normal Viewing Angle	(0.270)	(0.320)	(0.370)	--	BM-7A
		W _y		(0.300)	(0.350)	(0.400)		
Viewing Angle (6H)	Hor.	θ _R	CR≥10	60	70	--	Degree	
		θ _L		60	70	--		
	Ver.	θ _U		40	50	--		
		θ _D		50	60	--		

a. Test equipment setup

After stabilizing and leaving the panel alone shall be warmed up for the stable operation of LCM, the measurement should be executed. Measurement should be executed in a stable, windless, and dark room. Optical specifications are measured by Topcon BM-7(fast) with a viewing angle of 2° at a distance of 50cm and normal direction.

b. Definition of response time: Tr and Tf

The response time is defined as the following figure and shall be measured by switching the input signal for "black" and "white".

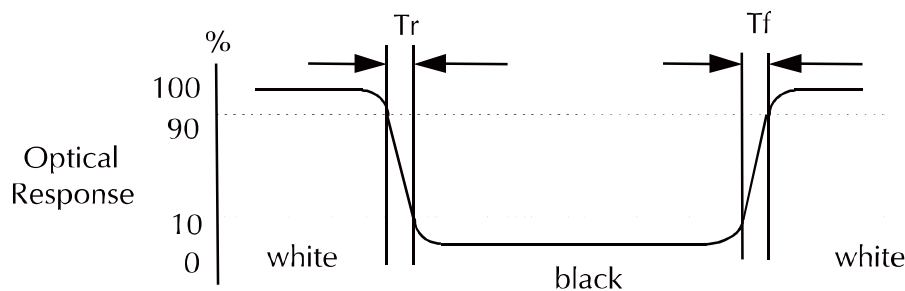

c. Definition of contrast ratio:

$$\text{Contrast Ratio (CR)} = \frac{\text{Brightness measured when LCD is at "white state"}}{\text{Brightness measured when LCD is at "black state"}}$$

- d. Measured at the center area of the panel when all the input terminals of LCD panel are electrically opened.
- e. View Angle

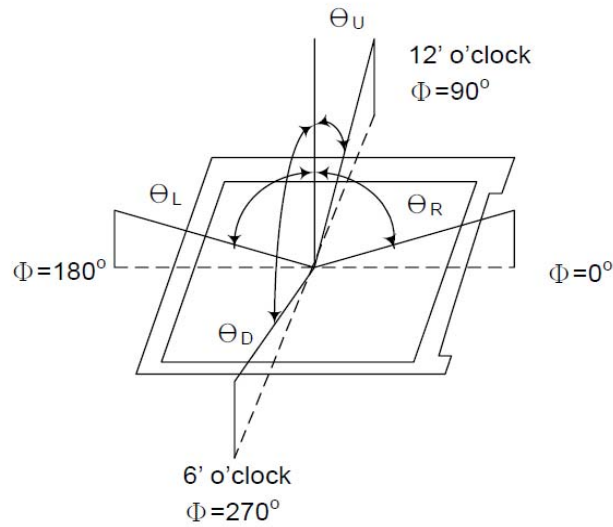

- f. Definition of Luminance of White: Luminance of white at the center points

Light Source of Back-Light Unit	LED Type
---------------------------------	----------

- g. Definition of White Uniformity

$$\text{White Uniformity} = \frac{\text{Min. luminance of white among 9-points}}{\text{Max. luminance of white among 9-points}} \times 100\%$$

- h. The definition of Color Gamut -Color Chromaticity CIE 1931

Color coordinate of white & red, green, blue at center point.

Color Gamut : NTSC(%) = (RGB Triangle Area / NTSC Triangle Area) x 100

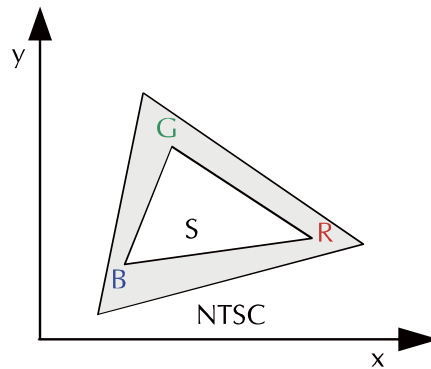

5. I/O Terminal

5.1 Pin Assignment (connector Part No: UJU MT-FP160N-2FR or equivalent.)

Pin No.	Symbol	I/O	Function	Remark
1	GND	P	Ground	
2	AVDD	P	Analog input voltage	
3	VCC	P	Digital input voltage	
4	R0	I	Red data signal (LSB)	
5	R1	I	Red data signal	
6	R2	I	Red data signal	
7	R3	I	Red data signal	
8	R4	I	Red data signal	
9	R5	I	Red data signal	
10	R6	I	Red data signal	
11	R7	I	Red data signal (MSB)	
12	G0	I	Green data signal (LSB)	
13	G1	I	Green data signal	
14	G2	I	Green data signal	
15	G3	I	Green data signal	
16	G4	I	Green data signal	
17	G5	I	Green data signal	
18	G6	I	Green data signal	
19	G7	I	Green data signal (MSB)	
20	B0	I	Blue data signal (LSB)	
21	B1	I	Blue data signal	
22	B2	I	Blue data signal	
23	B3	I	Blue data signal	
24	B4	I	Blue data signal	
25	B5	I	Blue data signal	
26	B6	I	Blue data signal	
27	B7	I	Blue data signal (MSB)	
28	CLKIN	I	Dot clock input	
29	DEN	I	Data enable signal	
30	HSD	I	HSYNC signal	
31	VSD	I	VSYNC signal	
32	MODE	I	H: DE mode (Default) L: SYNC mode	
33	NC	-	No Connect (please leave it open)	
34	NC	-	No Connect (please leave it open)	
35	NC	-	NO Connect (please leave it open)	
36	VCC	P	Digital input voltage	
37	NC	-	NO Connect (please leave it open)	
38	GND	P	Ground	
39	GND	P	Ground	
40	AVDD	P	Analog input voltage	
41	VCOM	P	VCOM DC input	

42	DITH	I	Dithering function setting H: Disable dithering function L: Enable dithering function	
43	NC	-	NO Connect (please leave it open)	
44	VCOM out	O	connect a capacitor	
45	NC	-	NO Connect (please leave it open)	
46	NC	-	NO Connect (please leave it open)	
47	NC	-	NO Connect (please leave it open)	
48	NC	-	NO Connect (please leave it open)	
49	NC	-	NO Connect (please leave it open)	
50	NC	-	NO Connect (please leave it open)	
51	NC	-	NO Connect (please leave it open)	
52	NC	-	NO Connect (please leave it open)	
53	NC	-	NO Connect (please leave it open)	
54	NC	-	NO Connect (please leave it open)	
55	NC	-	NO Connect (please leave it open)	
56	VGH	P	TFT turn on voltage	
57	VCC	P	Digital input voltage	
58	VGL	P	TFT turn off voltage	
59	GND	P	Ground	
60	NC	-	NO Connect (please leave it open)	

I: Input, P: Power

Notes (1): VSS Pin must ground contact, can not be floating.

5.2 Back Light Unit (Connector Part No: JST:BHSR-02VS-01(N) or equivalent.)

Pin No.	Symbol	Function	Remark
1	LEDA	Power Supply for LED backlight	Red
2	LEDK	GND for LED backlight	White

5.3 Block Diagram

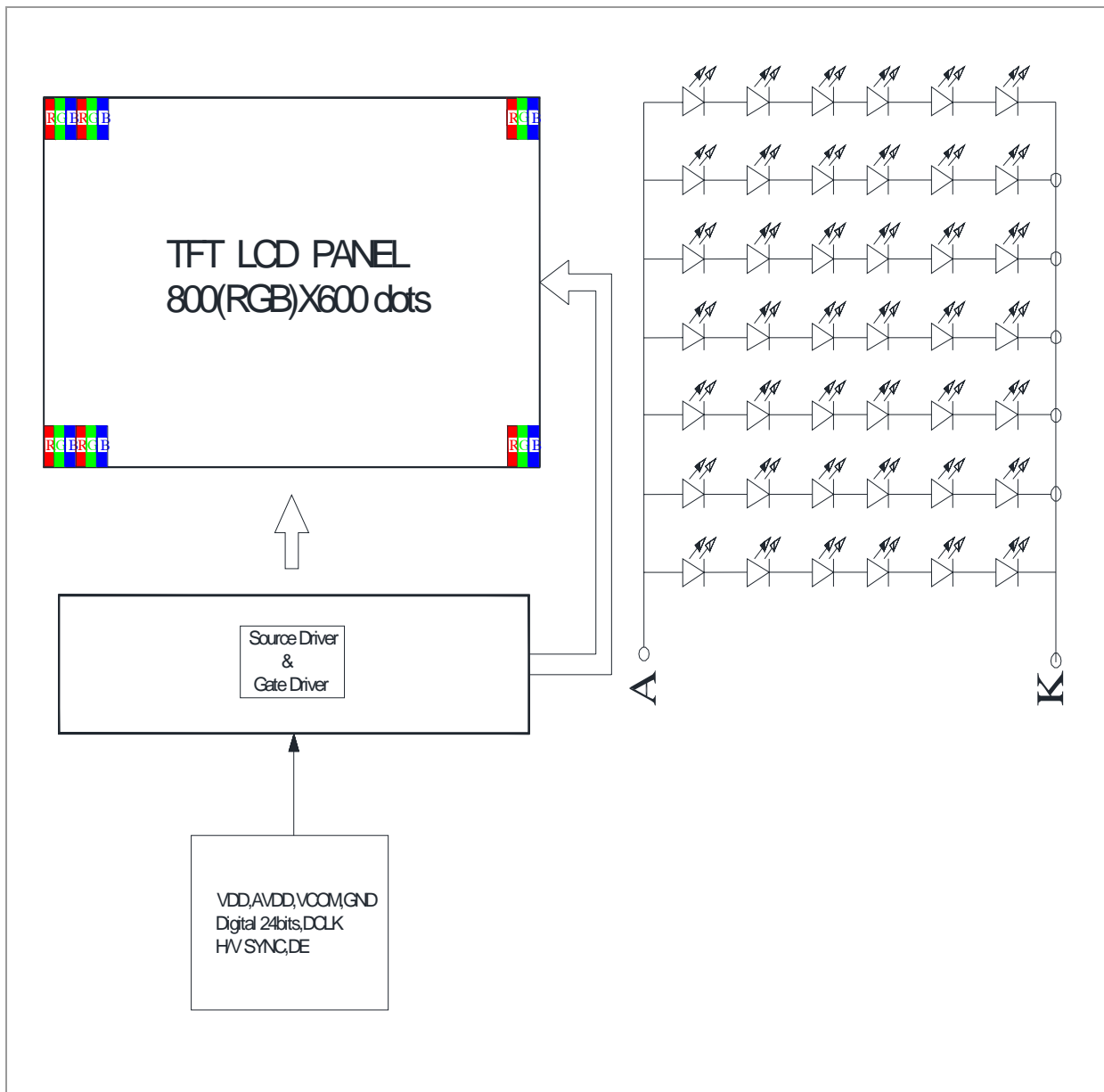

6. Displayed Color and Input Data

	Color & Gray Scale	Data Signal																							
		R7	R6	R5	R4	R3	R2	R1	R0	G7	G6	G5	G4	G3	G2	G1	G0	B7	B6	B5	B4	B3	B2	B1	B0
Basic Color	Black	0	0	0	0	0	0	0	0	0	0	0	0	0	0	0	0	0	0	0	0	0	0	0	0
	Red(0)	1	1	1	1	1	1	1	1	0	0	0	0	0	0	0	0	0	0	0	0	0	0	0	0
	Green(0)	0	0	0	0	0	0	0	0	1	1	1	1	1	1	1	1	0	0	0	0	0	0	0	0
	Blue(0)	0	0	0	0	0	0	0	0	0	0	0	0	0	0	0	0	1	1	1	1	1	1	1	1
	Cyan	0	0	0	0	0	0	0	0	1	1	1	1	1	1	1	1	1	1	1	1	1	1	1	1
	Magenta	1	1	1	1	1	1	1	1	0	0	0	0	0	0	0	0	1	1	1	1	1	1	1	1
	Yellow	1	1	1	1	1	1	1	1	1	1	1	1	1	1	1	1	0	0	0	0	0	0	0	0
	White	1	1	1	1	1	1	1	1	1	1	1	1	1	1	1	1	1	1	1	1	1	1	1	1
Red	Black	0	0	0	0	0	0	0	0	0	0	0	0	0	0	0	0	0	0	0	0	0	0	0	
	Red(1)	0	0	0	0	0	0	0	1	0	0	0	0	0	0	0	0	0	0	0	0	0	0	0	
	Red(2)	0	0	0	0	0	0	1	0	0	0	0	0	0	0	0	0	0	0	0	0	0	0	0	
	:	:	:	:	:	:	:	:	:	:	:	:	:	:	:	:	:	:	:	:	:	:	:	:	
	Red(127)	0	1	1	1	1	1	1	1	0	0	0	0	0	0	0	0	0	0	0	0	0	0	0	
	:	:	:	:	:	:	:	:	:	:	:	:	:	:	:	:	:	:	:	:	:	:	:	:	
	Red(254)	1	1	1	1	1	1	1	0	0	0	0	0	0	0	0	0	0	0	0	0	0	0	0	
	Red(255)	1	1	1	1	1	1	1	1	0	0	0	0	0	0	0	0	0	0	0	0	0	0	0	
Green	Black	0	0	0	0	0	0	0	0	0	0	0	0	0	0	0	0	0	0	0	0	0	0	0	
	Green(1)	0	0	0	0	0	0	0	0	0	0	0	0	0	0	0	1	0	0	0	0	0	0	0	
	Green(2)	0	0	0	0	0	0	0	0	0	0	0	0	0	0	1	0	0	0	0	0	0	0	0	
	:	:	:	:	:	:	:	:	:	:	:	:	:	:	:	:	:	:	:	:	:	:	:	:	
	Green(127)	0	0	0	0	0	0	0	0	0	1	1	1	1	1	1	1	0	0	0	0	0	0	0	
	:	:	:	:	:	:	:	:	:	:	:	:	:	:	:	:	:	:	:	:	:	:	:	:	
	Green(254)	0	0	0	0	0	0	0	0	1	1	1	1	1	1	1	0	0	0	0	0	0	0	0	
	Green(255)	0	0	0	0	0	0	0	0	1	1	1	1	1	1	1	1	0	0	0	0	0	0	0	
Blue	Black	0	0	0	0	0	0	0	0	0	0	0	0	0	0	0	0	0	0	0	0	0	0	0	
	Blue(1)	0	0	0	0	0	0	0	0	0	0	0	0	0	0	0	0	0	0	0	0	0	0	1	
	Blue(2)	0	0	0	0	0	0	0	0	0	0	0	0	0	0	0	0	0	0	0	0	0	0	1	
	:	:	:	:	:	:	:	:	:	:	:	:	:	:	:	:	:	:	:	:	:	:	:	:	
	Blue(127)	0	0	0	0	0	0	0	0	0	0	0	0	0	0	0	0	0	1	1	1	1	1	1	
	:	:	:	:	:	:	:	:	:	:	:	:	:	:	:	:	:	:	:	:	:	:	:	:	
	Blue(254)	0	0	0	0	0	0	0	0	0	0	0	0	0	0	0	0	1	1	1	1	1	1	0	
	Blue(255)	0	0	0	0	0	0	0	0	0	0	0	0	0	0	0	0	1	1	1	1	1	1	1	

0 : Low level voltage, 1 :High level voltage

Each basic color can be displayed in 256 gray scales from 8 bit data signals. With the combination of total 24 bit data signals, the 16.2M-color display can be achieved on the screen.

7. Reliability Condition

No change on display and in operation under the following test condition.

Condition: Unless otherwise specified, tests will be conducted under the following condition.

Temperature: 20±5°C.

Humidity: 65±5%RH.

Tests will be not conducted under functioning state.

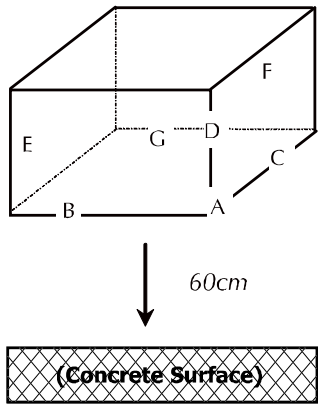
No.	Parameter	Condition	Notes
1	High Temperature Operating	70°C±2°C, 240hrs (Operation state).	
2	Low Temperature Operating	-20°C±2°C, 240hrs (Operation state).	1
3	High Temperature Storage	80°C±2°C, 240hrs.	2
4	Low Temperature Storage	-30°C±2°C, 240hrs.	1,2
5	High Temperature and High Humidity Operation Test	60°C±2°C, 90%, 240hrs.	1,2
6	Vibration Test	Total fixed amplitude: 1.5mm. Vibration Frequency: 10~55Hz. One cycle 60 seconds to 3 direction of X, Y, Z each 15 minutes.	3
7.	Drop Test	To be measured after dropping from 60cm high on the concrete surface in packing state.  <i>Dropping method corner dropping:</i> <i>A corner: Once edge dropping.</i> <i>B, C, D edge: Once face dropping.</i> <i>E, F, G face: Once.</i>	

- Notes:
1. No dew condensation to be observed.
 2. The function test shall be conducted after 4 hours storage at the normal temperature and humidity after removed from the test chamber.
 3. Vibration test will be conducted to the product itself without putting I in a container.

8. Dimensional Outlines

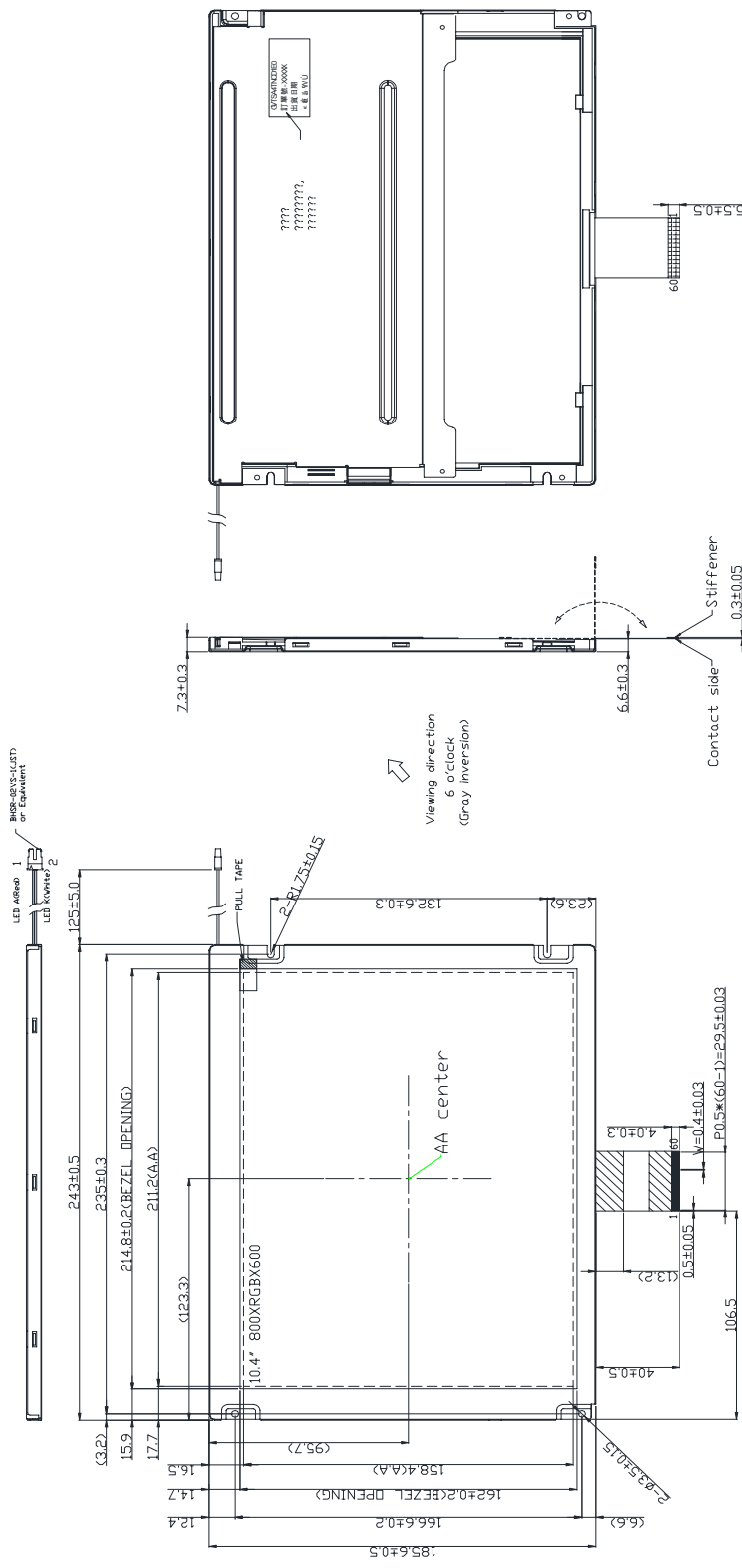

DN

No.	Symbol	21	B1	41	VCOM
1	GN0	22	B2	42	DITH
2	AVDD	23	B3	43	NC
3	VCC	24	B4	44	VCOM
4	R0	25	B5	45	NC
5	R1	26	B6	46	NC
6	R2	27	B7	47	NC
7	R3	28	CLKIN	48	NC
8	R4	29	TEN	49	NC
9	P5	30	HSD	50	NC
10	R6	31	VSD	51	NC
11	R7	32	MODE	52	NC
12	G0	33	NC	53	NC
13	G1	34	NC	54	NC
14	G2	35	NC	55	NC
15	G3	36	VCC	56	VGH
16	G4	37	NC	57	VCC
17	G5	38	GN0	58	VGL
18	G6	39	GN0	59	GN0
19	G7	40	AVDD	60	NC
20	R0				

Connector:UJU MT-FP160N-2FR or Equivalent

Coverlay open



9. Incoming Inspection Standards

9.1 Inspection and Environment Conditions

9.1.1 Inspection Conditions:

- (1) Inspection Distance: 35 cm±5cm
- (2) View Angle : Light-on Inspection Angle : ±5°
Cosmetic Inspection Angle : ±45°

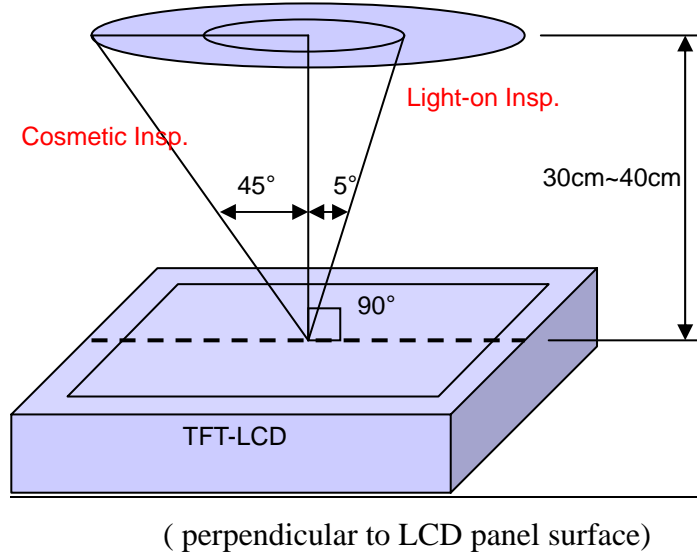

9.1.2 Environment Conditions:

Ambient Temperature		23°C±5°C
Ambient Humidity		55±10%RH
Ambient Illumination	Cosmetic Inspection	more than 600 Lux
	Functional Inspection	300~500 Lux

9.1.3 Sampling Conditions:

- (1) Lot Size: Quantity of shipment lot per model
- (2) Sampling Method:

Sampling Plan		MIL-STD-105E
		Normal Inspection, Single Sampling Level II
AQL	Major Defect	1.0%
	Minor Defect	1.5%

- (3) The classification of Major(MA) and Minor(MI) defects is shown as 3. Inspection Criteria.

9.1.4 Inspection Criteria

9.1.4.1 Cosmetic Inspection(Panel):

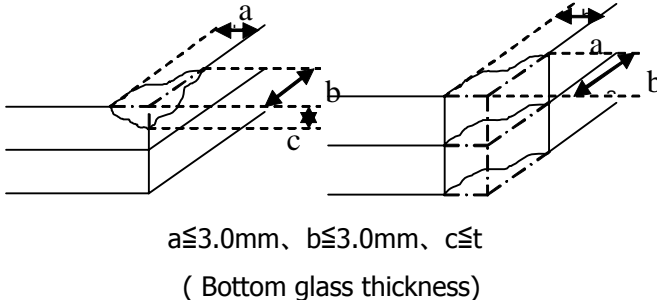
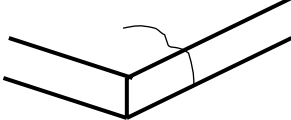
Item	Judgment Criteria	Classification
Chipping on Panel	 <p>$a \leq 3.0\text{mm}$, $b \leq 3.0\text{mm}$, $c \leq t$ (Bottom glass thickness)</p>	MA
Scratch on Panel *Note-2	<p>$W \leq 0.05\text{mm}$ or $L < 5\text{mm}$: Ignored $0.05\text{mm} < W \leq 0.1\text{mm}$ and $L \leq 5\text{mm}$: $N \leq 5$ $W > 0.1\text{mm}$ or $L > 5\text{mm}$: Not allowed</p>	MI
Bubble or Dent on Panel *Note-3	<p>$D \leq 0.2\text{mm}$: Ignored $0.2\text{mm} < D \leq 0.3\text{mm}$: $N \leq 5$ $D > 0.3\text{mm}$: Not allowed</p>	MI
Panel Crack	 <p>Not Allowed crack</p>	MA
Bezel Deformation	Obvious deformation is not allowed.	MI
Bezel Oxidation	Not allowed if it rusts continuously over 1 cm (It is out of warranty with rusted tin plate)	MI
Bezel Scratch	L 20mm , W 0.2 , N 3	MI
Metal Squash Dent /Flange(Front Side)	D(W) 1,L 3,N 3;	MI
B/L High Voltage Wire Denudation	Not allowed	MA
Polarizer flaw or leak out resin	Defect is defined as the active area.	MI
Outline Dimension	Must in Spec, refer to related product spec.	MI

9.1.4.2 Functional Inspection:

Item	Judgment Criteria			Classification	
	Area(Note1)	I	O		
Point Defect	Bright dot	Random	2		MI
		2 dots adjacent	0	0	
		3 dots adjacent or more	0	0	
	Dark dot	Random	3		
		2 dots adjacent	1		
		3 dots adjacent or more	0	0	
	Total Dot Defect		5		
	Distance	Distance between Bright and Bright dot	L 5mm		
		Distance between Bright and Dark dot	L 5mm		
		Distance between Dark dot	L 5mm		
(1) It is defined as Point Defect if defect area > 0.5dot (2) It is ignored if defect area ≤ 0.5dot (3) Weak point defect will be defined as Bright Dot if it can be observed through ND filter 5% (Full Screen Black Inspection)					
Line Defect	Obvious vertical or horizontal line defect is not allowed.			MA	
Mura	Not allowed if it can be observed through ND Filter 5 %			MI	
Foreign Material in spot shape *Note-3	D ≤ 0.2mm: Ignored 0.2mm < D ≤ 0.5mm: N ≤ 8 D > 0.5mm: Not allowed			MI	
Foreign Material in line or spiral shape *Note-4	W ≤ 0.05mm or L ≤ 5mm: Ignored 0.05mm < W ≤ 0.2mm and L 1.0mm ≤ 5mm: N ≤ 8 W > 0.2mm or L > 5mm: Not allowed			MI	
Display Function Abnormal	No Malfunction can be allowed			MA	

Note-1 : I/O Area Definition

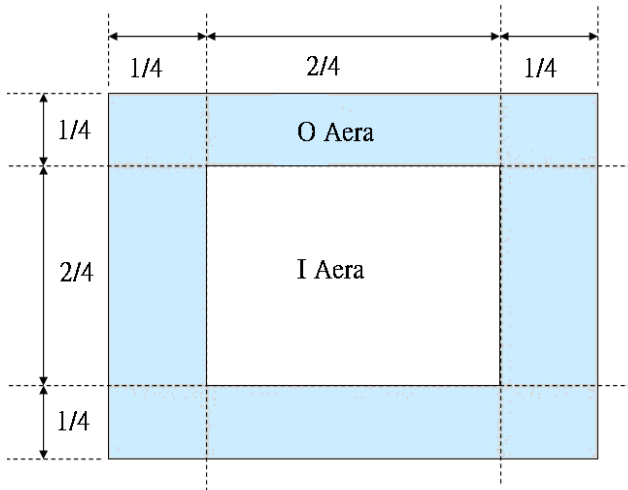

Note-2 : Polarizer Scratch

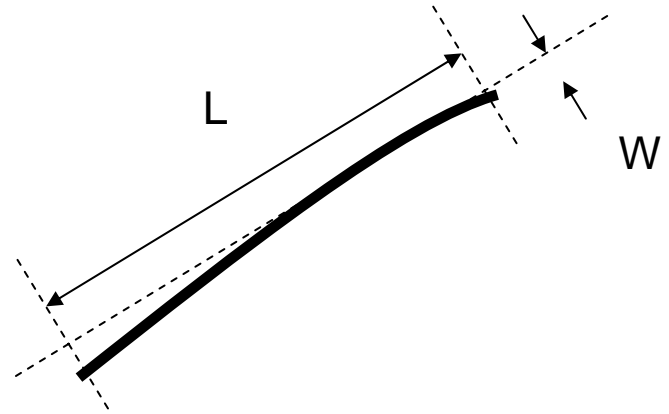

Note-3 : Spot Foreign Material

$$(W \geq L / 4)$$

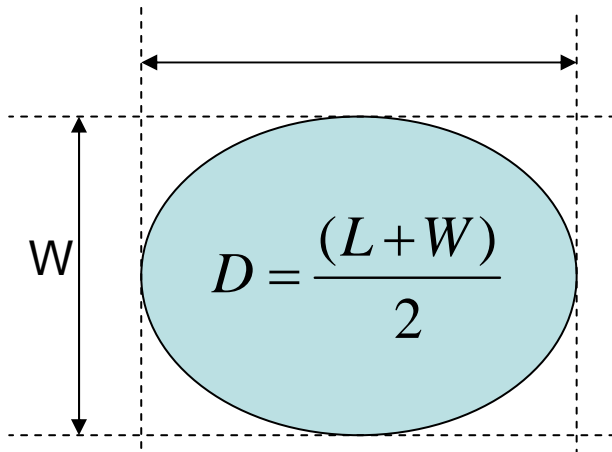

Note-4 : Line or Spiral Foreign Material

$$(W < L / 4)$$

