

2J7A85JBa-B16J

2× 5GNR MIMO and 2.4/5.0/6.0 GHz ISM Pole/Screw Mount

Key Features

Cable 1 - 2: 5GNR

- 617-960 MHz
- 1427-2690 MHz
- 3300-5000 MHz
- 5150-5925 MHz

Cable 3: 2.4/5.0/6.0 GHz ISM

- 2410-2490 MHz
- 4920-5925 MHz
- 5915-7125 MHz

Pole/Screw Mount

Heavy Duty antenna

High Performance

Ground Plane Independent

Anti-Rotation Mounting

Customizable Cable and Connector

Dimensions:

Ø 96 × H 160 - Pole Mount

Ø 96 × H 91 - Screw Mount

Certificates: IP67, IP69, IK09

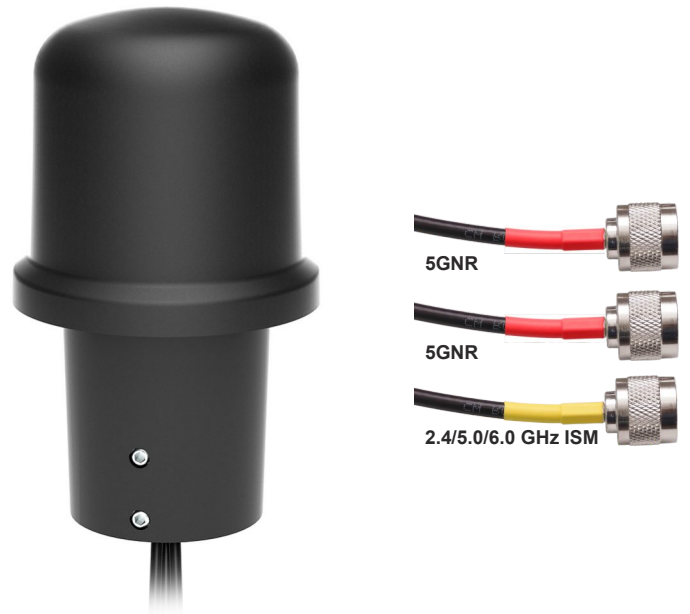

1. Antenna and electrical specifications

Cable 1

Parameters	5G NR Antenna			
Technologies	5G, 4G, 3G and 2G			
Standards	5G NR/4G LTE/FirstNet/CBRS/LPWA/CAT-X/CAT-Mx/CAT-NBx/NB-IoT/3G/2G			
Frequency (MHz)	617-960	1427-2690	3300-5000	5150-5925
Band (MHz)	600, 700, 850, 900	1500, 1600, 1700, 1800, 1900, 2000, 2100, 2300, 2500, 2600	3300, 3500, 3600, 3700, 4500	5200, 5500, 5800
5G NR Bands	n5, n8, 12, n20, n28, n71, n81, n82, n83,	n1, n2, n3, n7, n25, n34, n38, n39, n40, n41, n50, n51, n66, n70, n74, n75, n76, n80, n84, n86	n77, n78, n79	
4G LTE Bands	B5, B6, B8, B12, B13, B14, B17, B18, B19, B20, B26, B27, B28, B29, B44, B67, B68, B71, B85	B1, B2, B3, B4, B7, B9, B10, B11, B21, B23, B24, B25, B30, B32, B33, B34, B35, B36, B37, B38, B39, B40, B41, B45, B50, B51, B65, B66, B69, B70, B74, B75, B76	B22, B42, B43, B48, B49, B52	B46, B47, B252, B255
3G CELL Bands	B5, B6, B8, B12, B13, B14, B19, B20, B26	B1, B2, B3, B4, B7, B9, B10, B11, B21, B25, B32, B33, B34, B35, B36, B37, B38, B39, B40	B22	
2G CELL Bands	710, 750, 810T, 850, 900P, 900E, 900R	1800DCS, 1900PCS		
CDMA CELL Bands	BC0, BC2, BC3, BC7, BC9, BC10, BC12, BC18, BC19	BC1, BC4, BC6, BC8, BC13, BC14, BC15, BC16, BC20, BC21		
Return Loss (dB)	~-7.9	~-13.3	~-11.4	~-12.9
VSWR	~2.6:1	~1.7:1	~1.9:1	~1.7:1
Efficiency (%)	~45.0	~56.3	~43.3	~42.4
Peak Gain (dBi)	~1.4	~3.6	~3.3	~3.8
Average Gain (dB)	~-3.6	~-2.5	~-3.7	~-3.7
Impedance (Ohm)	50			
Polarisation	Linear			
Radiation Pattern	Omni-Directional			
Max. Input Power (W)	35			
Connector Type	SMA-Male Standard (Other Connectors Available)			
Cable Length	300 cm Standard (Any Cable Length Available)			
Cable Type	LL195 Standard (Other Cables Available)			

Cable 2

Parameters	5GNR Antenna			
Technologies	5G, 4G, 3G and 2G			
Standards	5GNR/4GLTE/FirstNet/CBRS/LPWA/CAT-X/CAT-Mx/CAT-NBx/NB-IoT/3G/2G			
Frequency (MHz)	617-960	1427-2690	3300-5000	5150-5925
Band (MHz)	600, 700, 850, 900	1500, 1600, 1700, 1800, 1900, 2000, 2100, 2300, 2500, 2600	3300, 3500, 3600, 3700, 4500	5200, 5500, 5800
5GNR Bands	n5, n8 ,12, n20, n28, n71, n81, n82, n83,	n1, n2, n3, n7, n25, n34, n38, n39, n40, n41, n50, n51, n66, n70, n74, n75, n76, n80, n84, n86	n77, n78, n79	
4GLTE Bands	B5, B6, B8, B12, B13, B14, B17, B18, B19, B20, B26, B27, B28, B29, B44, B67, B68, B71, B85	B1, B2, B3, B4, B7, B9, B10, B11, B21, B23, B24, B25, B30, B32, B33, B34, B35, B36, B37, B38, B39, B40, B41, B45, B50, B51, B65, B66, B69, B70, B74, B75, B76	B22, B42, B43, B48, B49, B52	B46, B47, B252, B255
3GCELL Bands	B5, B6, B8, B12, B13, B14, B19, B20, B26	B1, B2, B3, B4, B7, B9, B10, B11, B21, B25, B32, B33, B34, B35, B36, B37, B38, B39, B40	B22	
2GCELL Bands	710, 750, 810T, 850, 900P, 900E, 900R	1800DCS, 1900PCS		
CDMACELL Bands	BC0, BC2, BC3, BC7, BC9, BC10, BC12, BC18, BC19	BC1, BC4, BC6, BC8, BC13, BC14, BC15, BC16, BC20, BC21		
Return Loss (dB)	~-7.7	~-12.4	~-11.9	~-11.9
VSWR	~2.7:1	~1.7:1	~2.0:1	~1.8:1
Efficiency (%)	~45.4	~54.8	~43.0	~47.1
Peak Gain (dBi)	~1.5	~3.6	~3.5	~3.8
Average Gain (dB)	~-3.6	~-2.7	~-3.7	~-3.3
Impedance (Ohm)	50			
Polarisation	Linear			
Radiation Pattern	Omni-Directional			
Max. Input Power (W)	35			
Connector Type	SMA-Male Standard (Other Connectors Available)			
Cable Length	300 cm Standard (Any Cable Length Available)			
Cable Type	LL195 Standard (Other Cables Available)			

Cable 3

Parameters	2.4/5.0/6.0 GHz ISM Antenna		
Standards	WiFi, BT, ZigBee, ISM		
Band (MHz)	2.4 GHz	5.0 GHz	6.0 GHz
Frequency (MHz)	2410-2490	4920-5925	5925-7125
Return Loss (dB)	~-10.4	~-13.6	~-11.6
VSWR	~1.9:1	~1.6:1	~1.9:1
Efficiency (%)	~58	~64.0	~65.0
Peak Gain (dBi)	~5.6	~5.5	~3.8
Average Gain (dB)	~-2.3	~-1.9	~-1.8
Impedance (Ohm)	50		
Polarisation	Linear		
Radiation Pattern	Omni-Directional		
Max. Input Power (W)	25		
Connector Type	SMA-Male-RP Standard (Other Connectors Available)		
Cable Length	300 cm Standard (Any Cable Length Available)		
Cable Type	LL195 Standard (Other Cables Available)		

Antenna Measurement Conditions:

Mounted on Metal Plate of 30 x 30 cm
 100 cm of Cable LL195
 Measured in Certified CTIA 3D Anechoic Chamber

2. Mechanical and environmental specifications

Specifications	2J7A85JBa-B16J
Mounting Type	Pole (for pole with max Ø 43mm) / Screw Mount (max 7mm surface thickness)
Dimensions (mm)	Ø 96 × H 160 - Pole Mount / Ø 96 × H 91 - Screw Mount
Max. Tighten Torque (Nm)	6 Nm (for Screw Mount)
Radome	ASA
Radome color	White, Black
Antenna Base	ASA
Operating Temperature (C)	-40 to +85
Storage Temperature (C)	-40 to +85
Substance Compliance	RoHS
Certificates	IP67, IP69, IK09

3. Antenna parameters

Cable 1: 5GNR

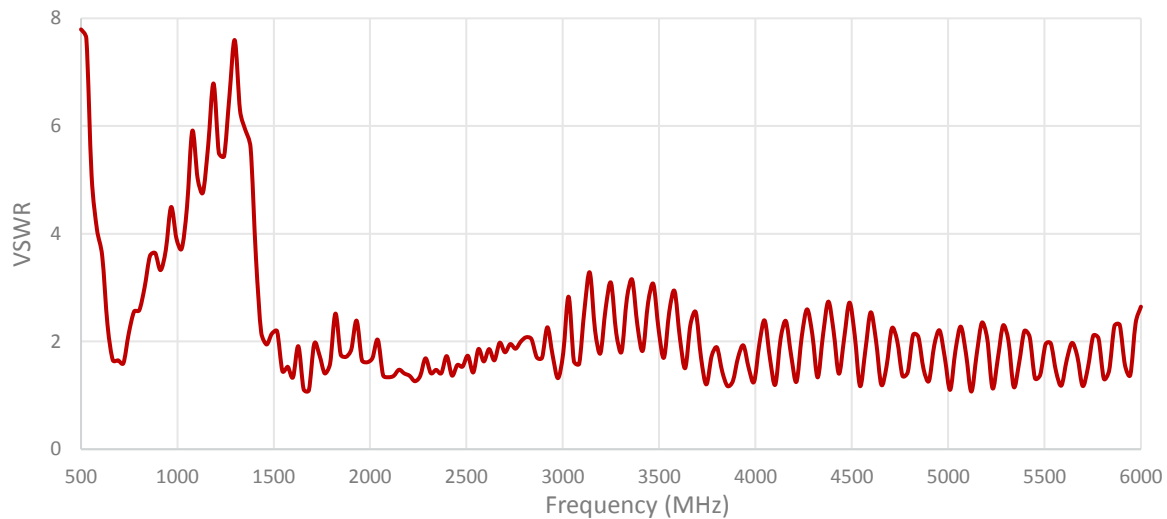
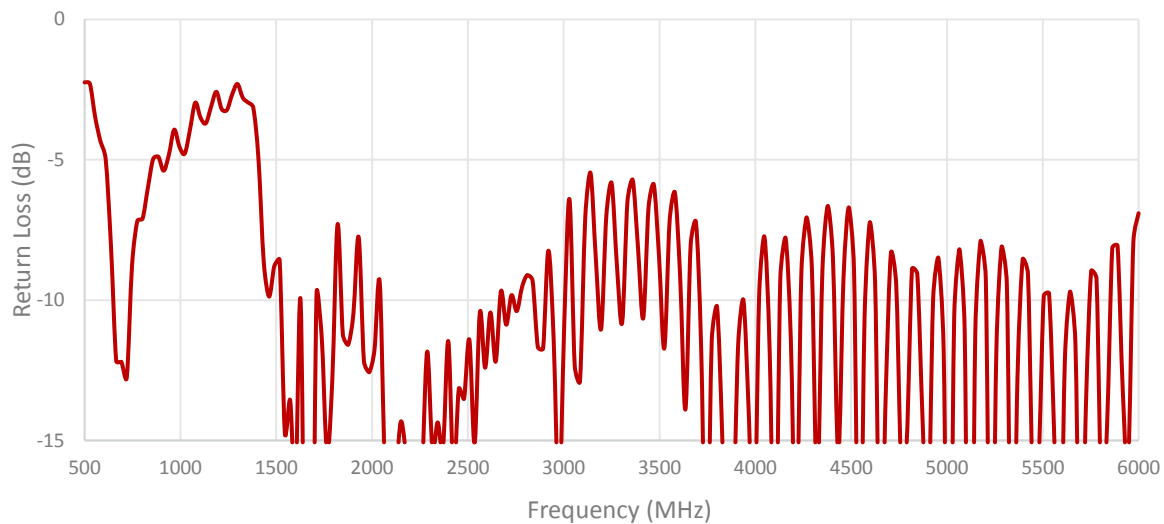

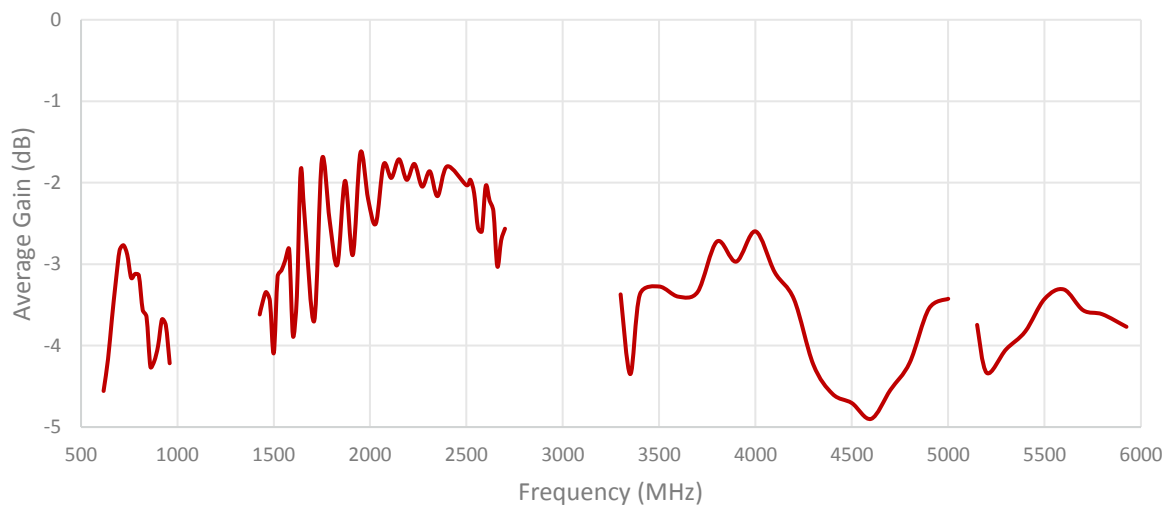
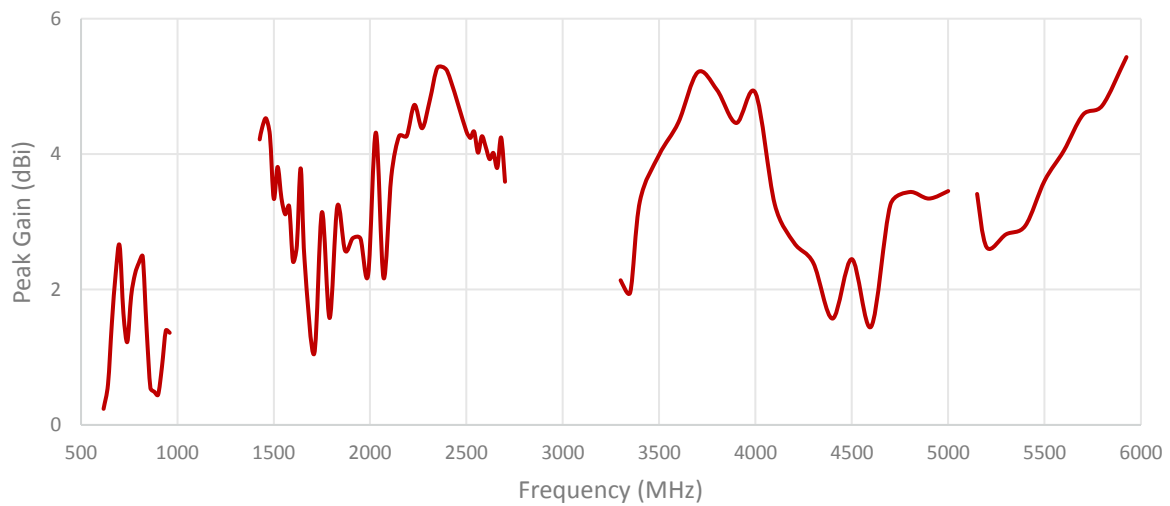
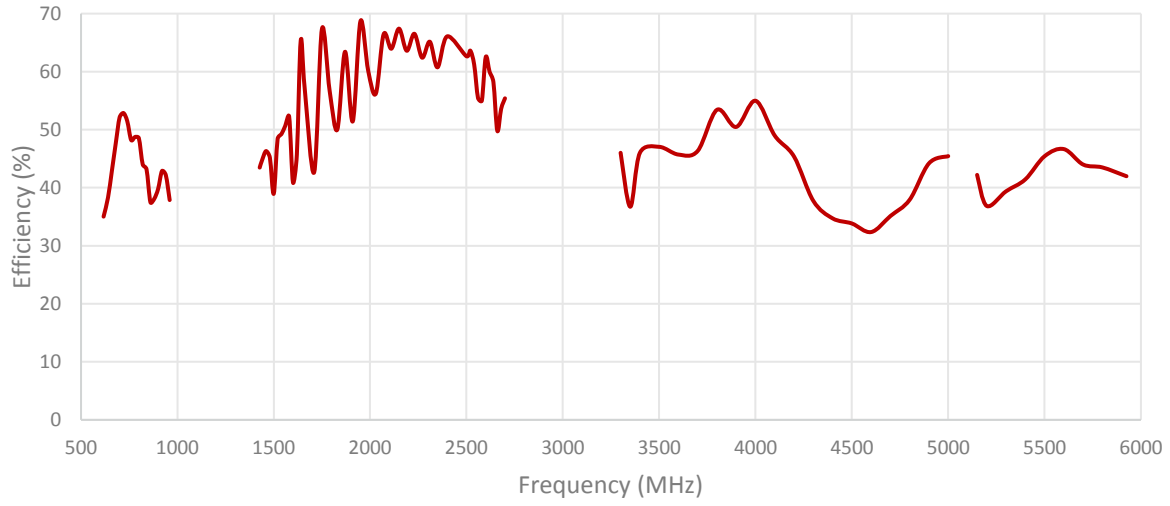

Cable 2: 5GNR

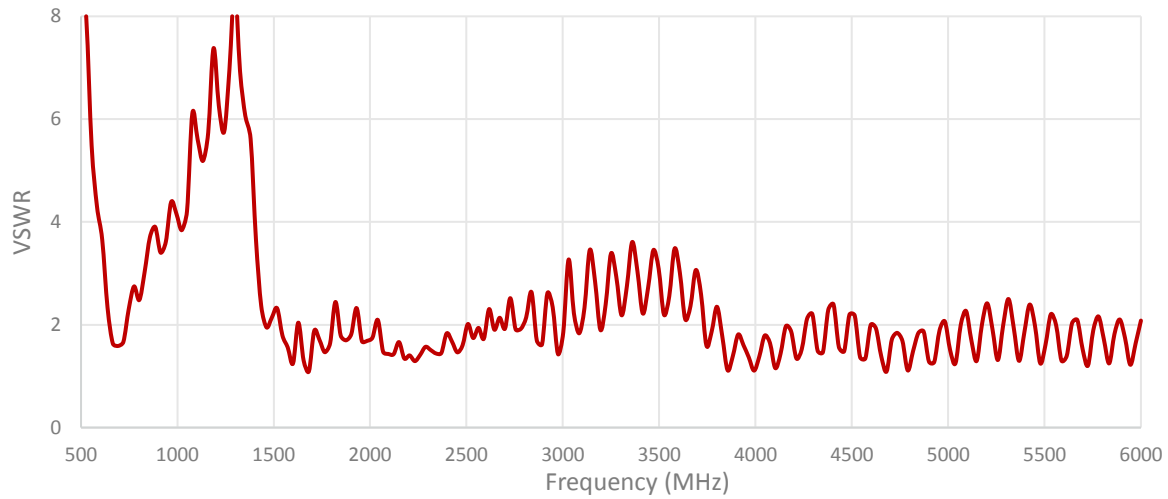
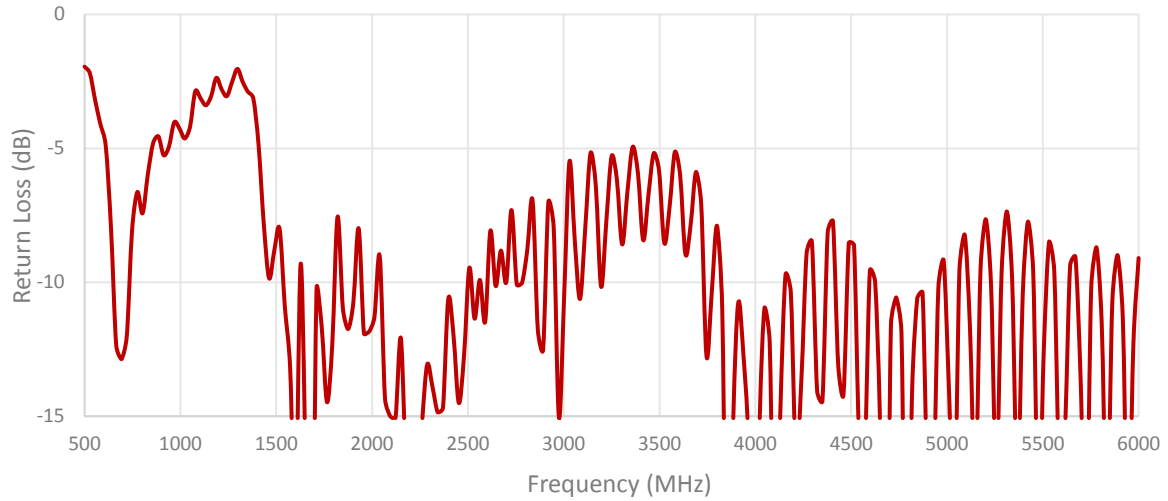

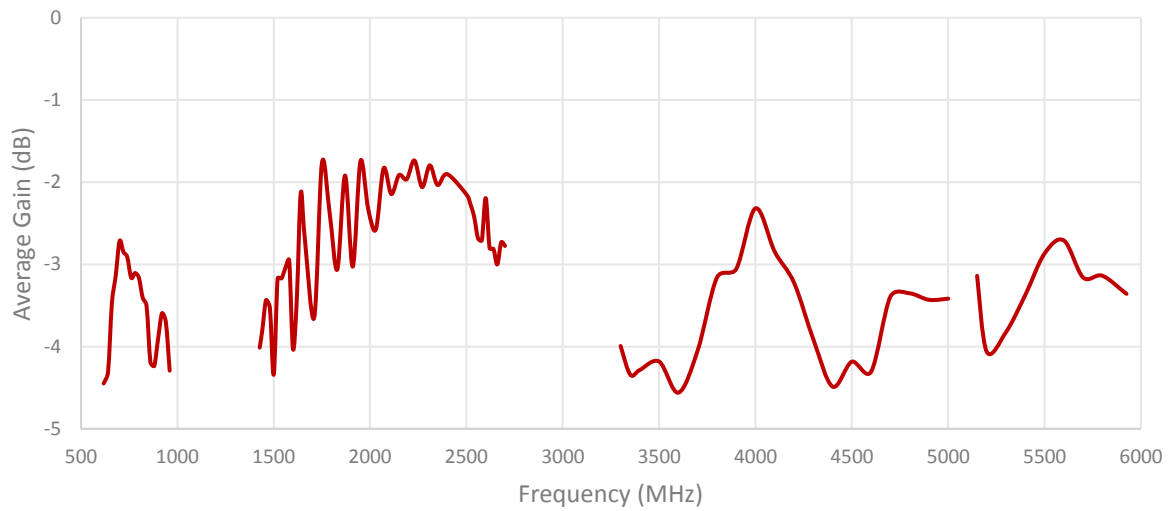
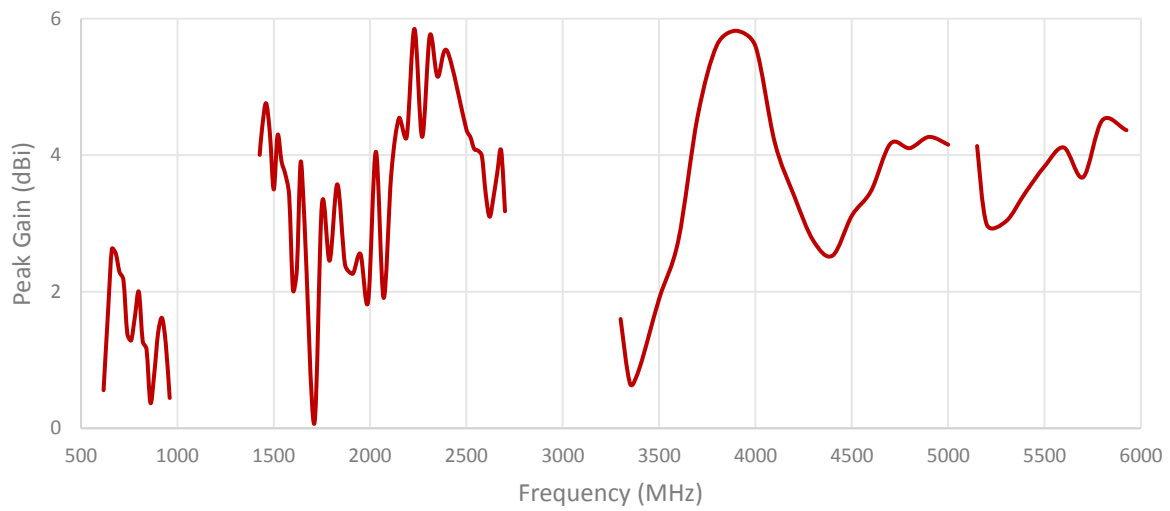
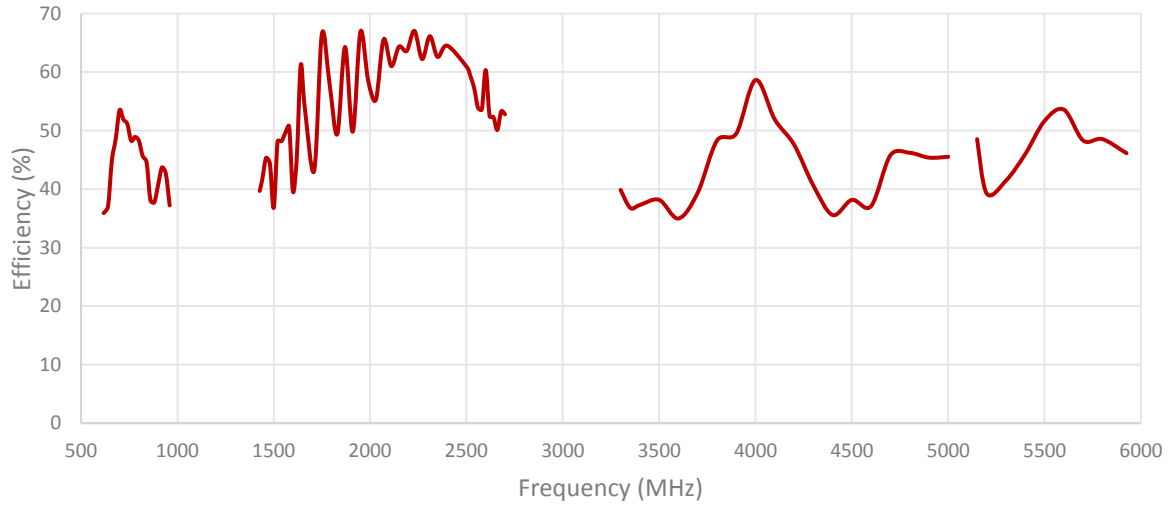

ISOLATION FOR CABLES 1 AND 2

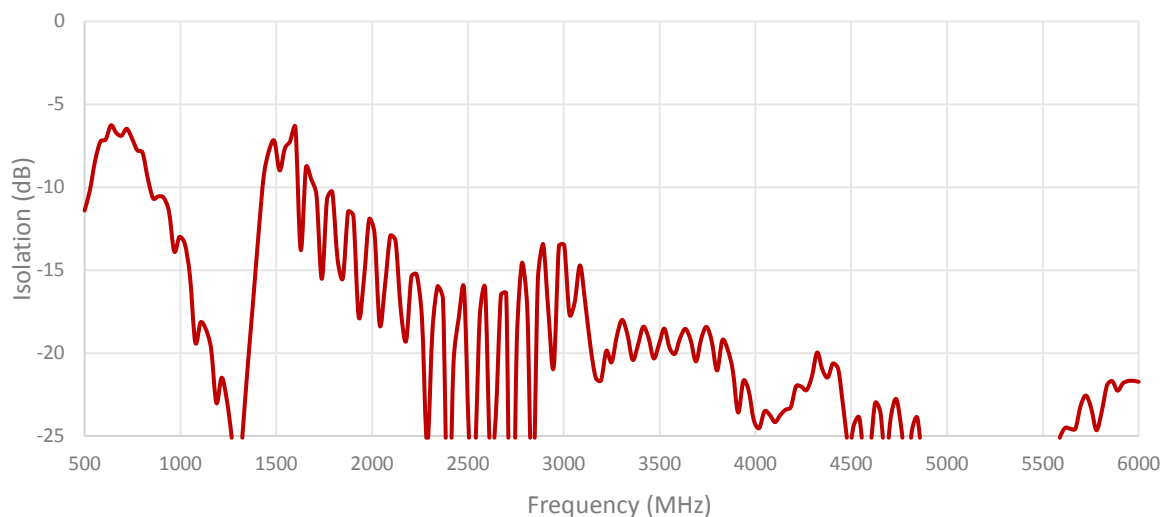

ENVELOPE CORRELATION COEFFICIENT FOR CABLES 1 AND 2

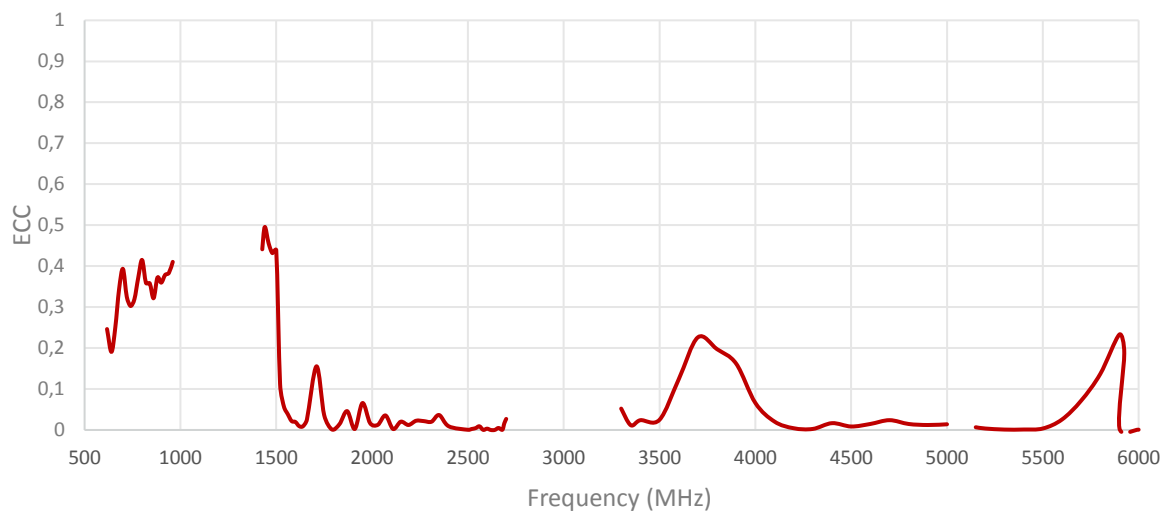

Cable 3: 2.4/5.0/6.0 GHz ISM

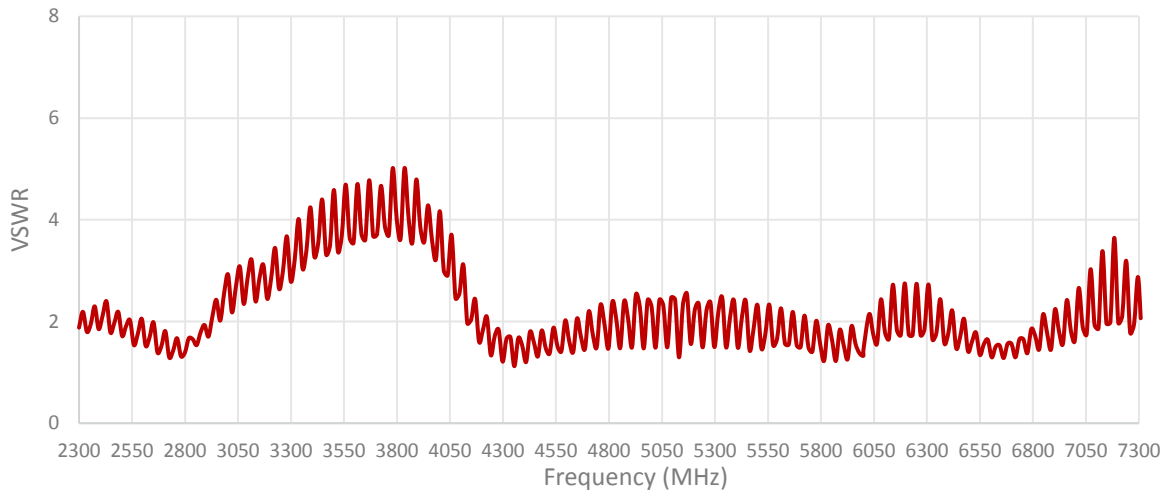
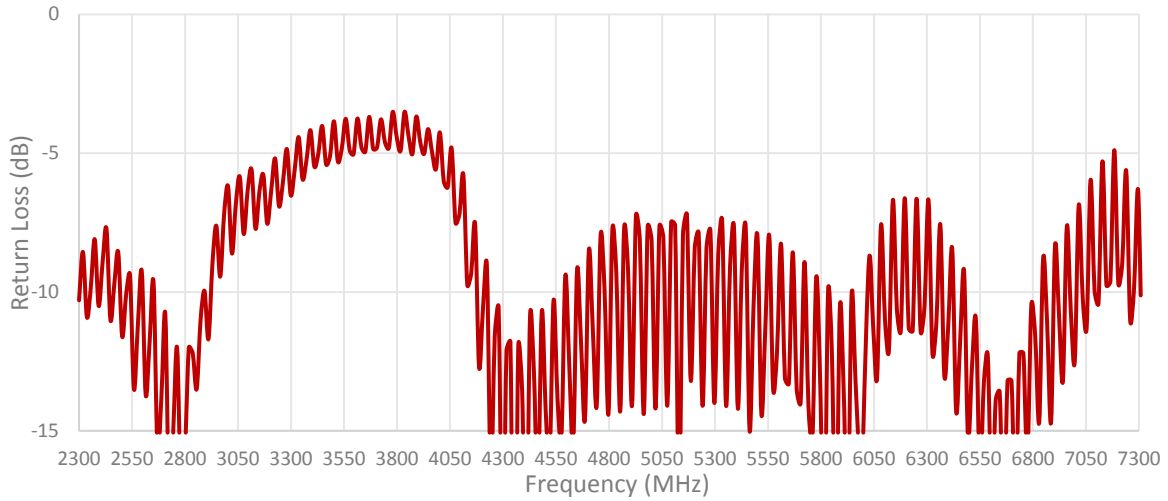

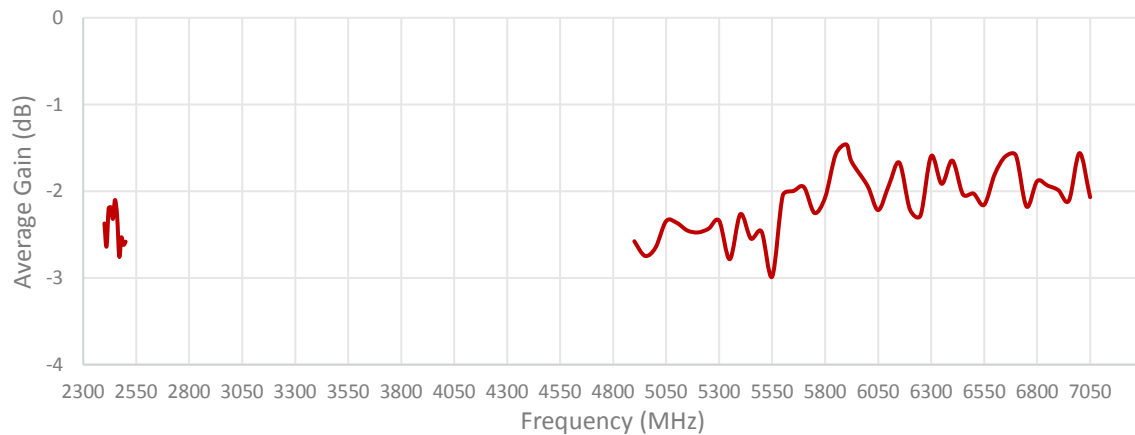
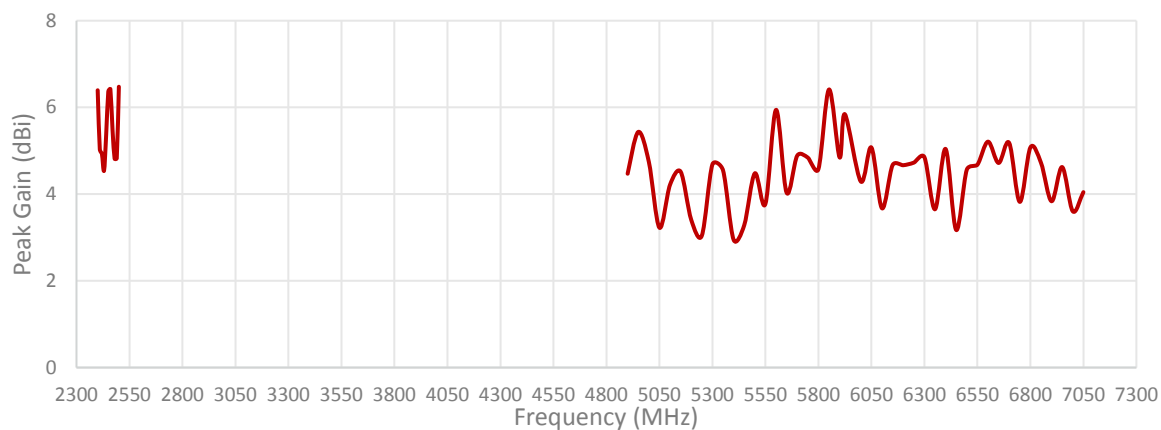
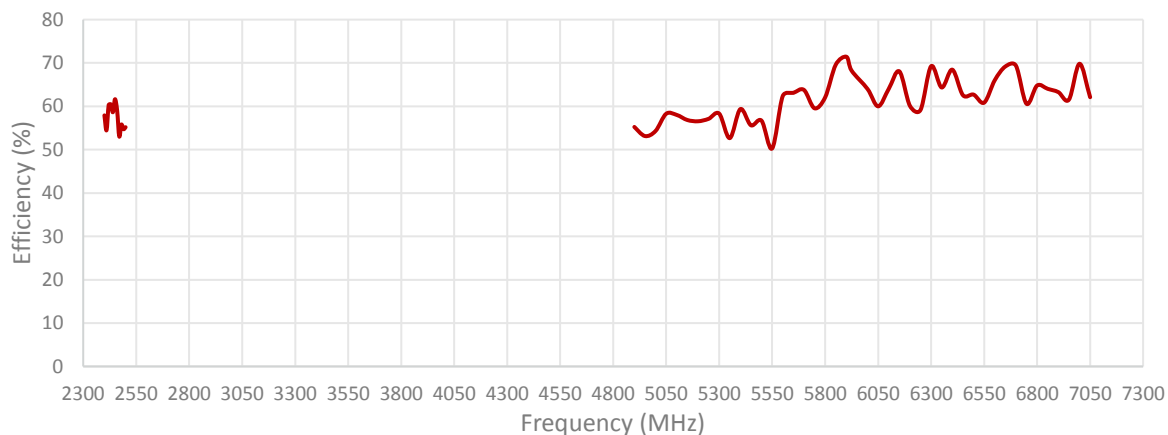

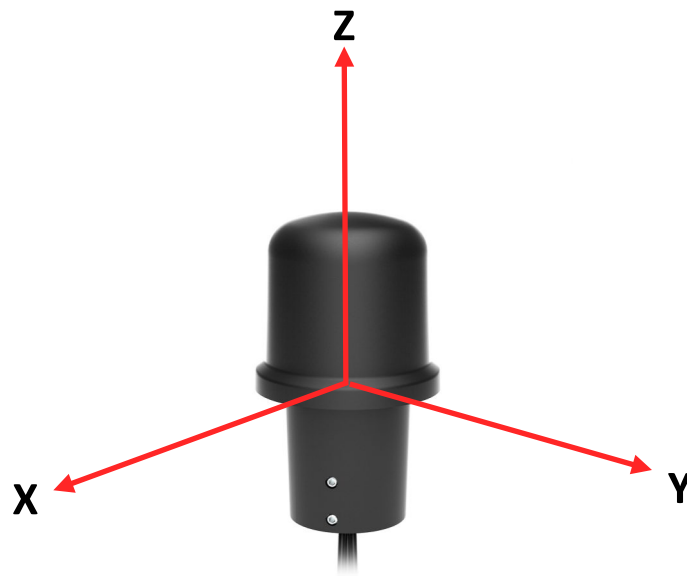

Radiation pattern reference

Cable 1: 5GNR

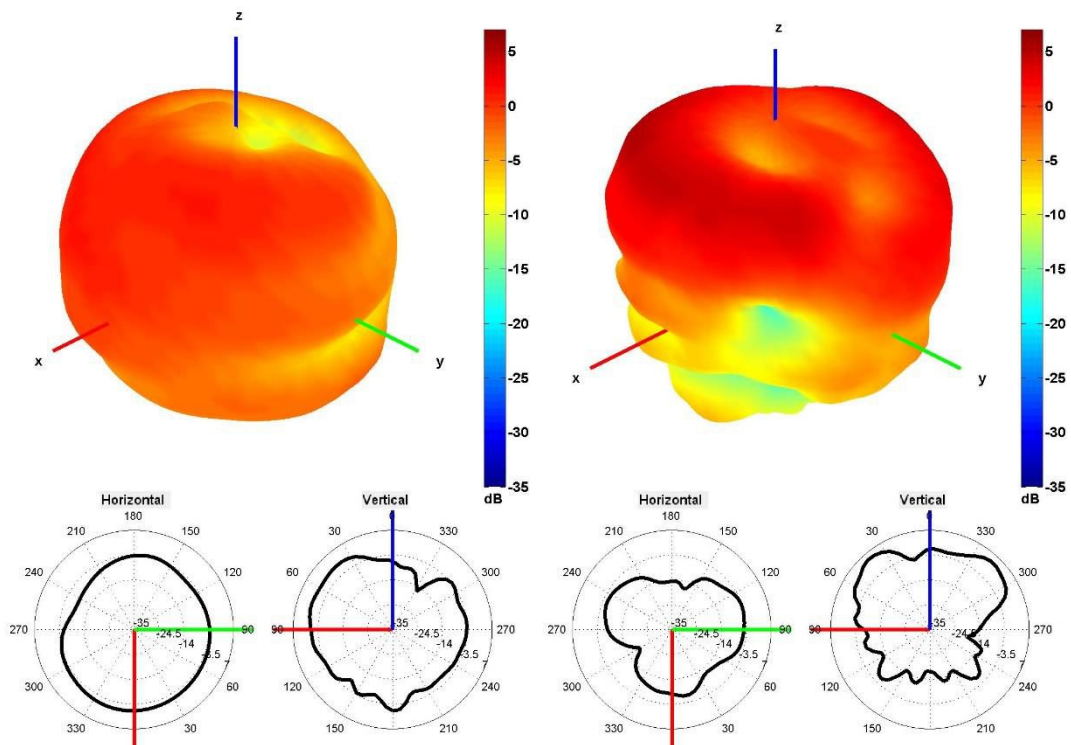

750 and 2500 MHz Radiation pattern

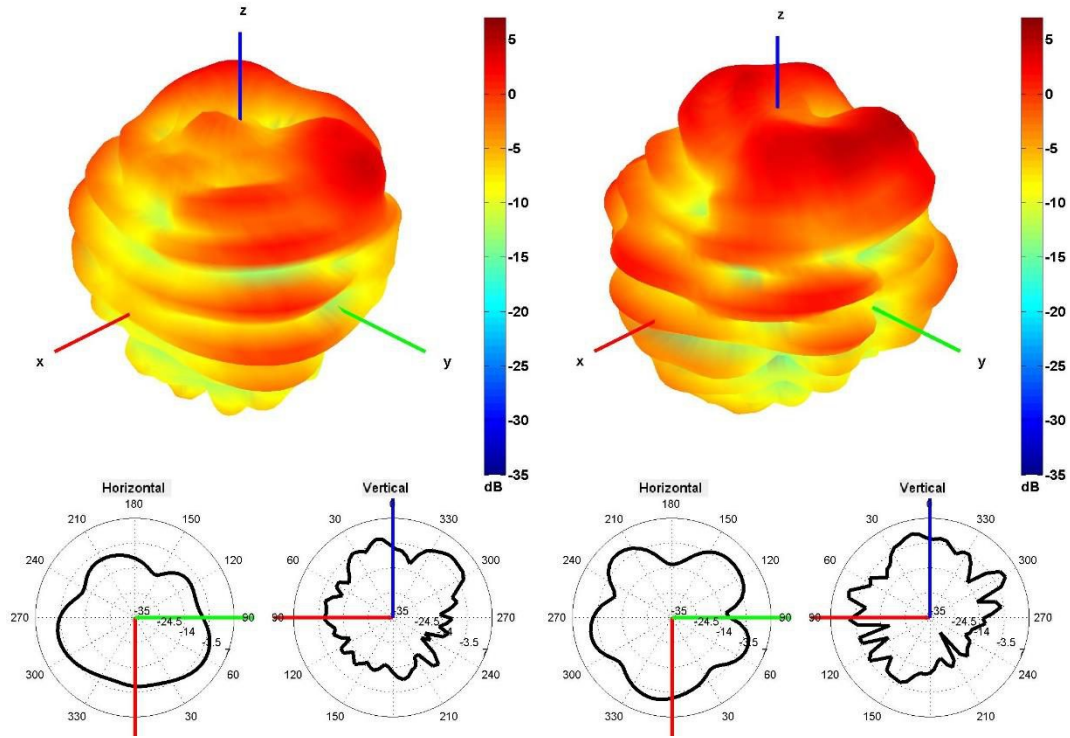

Cable 2: 5GNR

450 and 550 MHz Radiation pattern

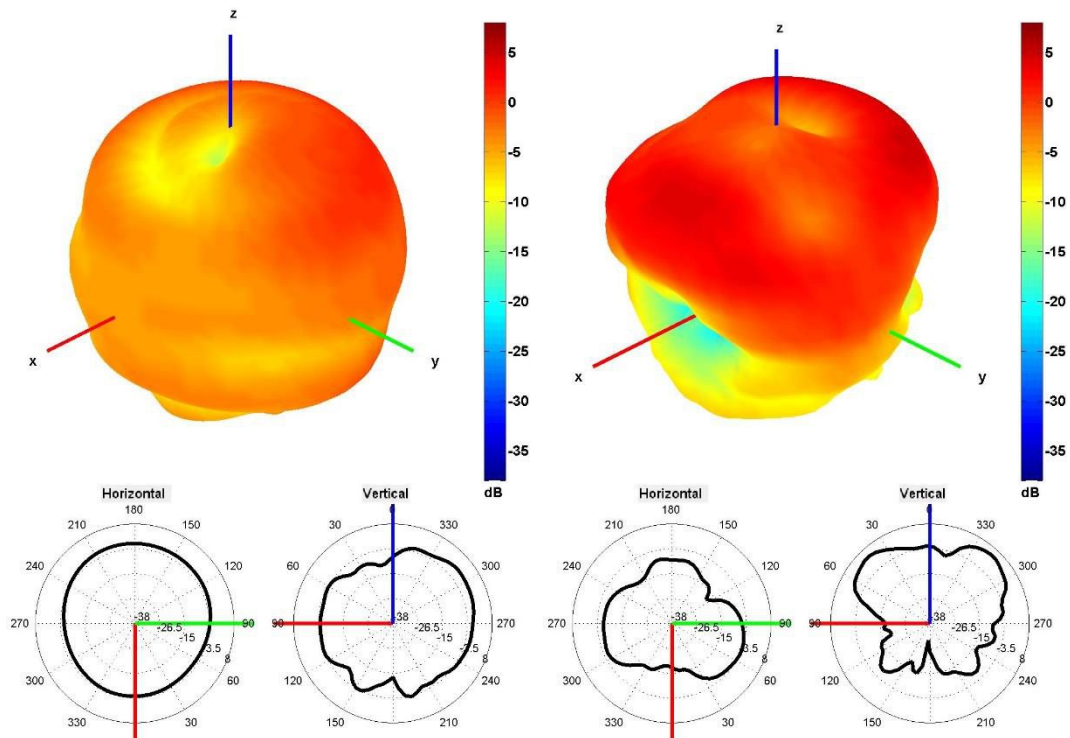

750 and 2500 MHz Radiation pattern

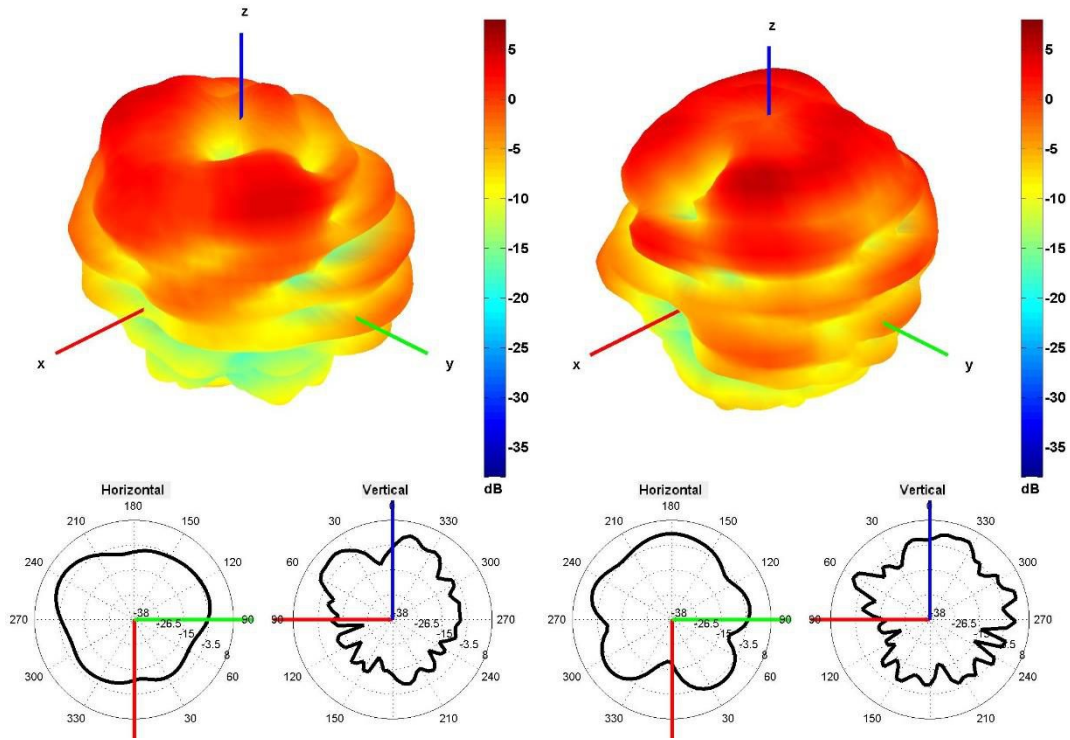

4500 and 5500 MHz Radiation pattern

Cable 3: 2.4/5.0/6.0 GHz ISM

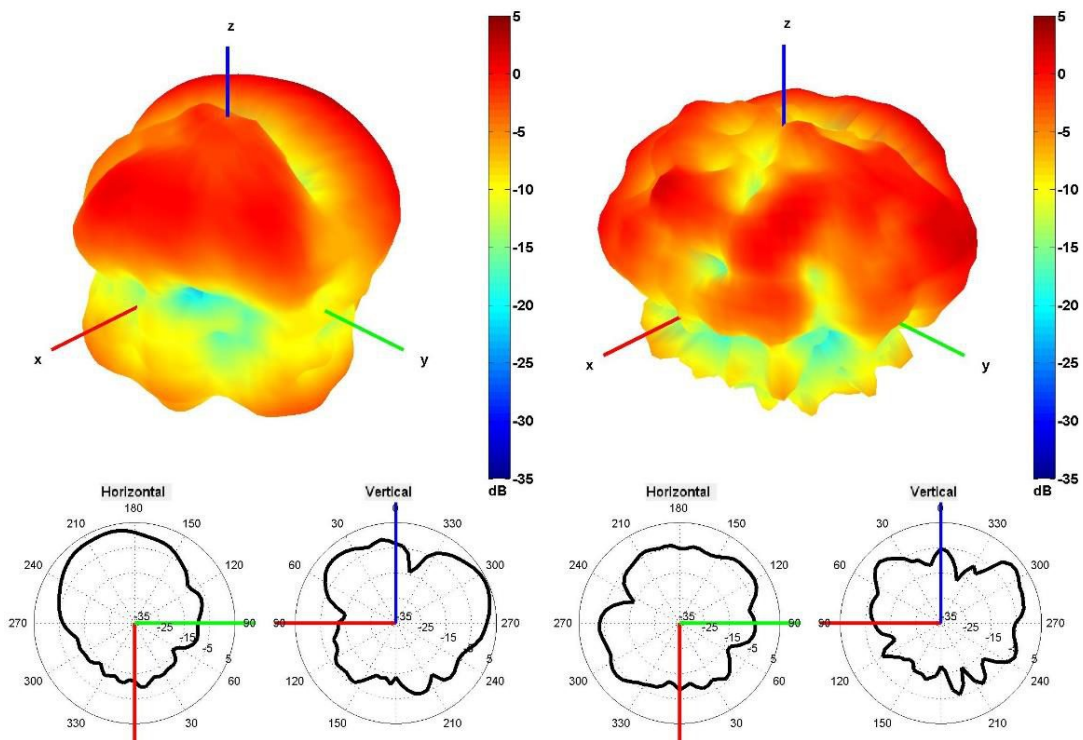

2450 and 5500 MHz Radiation pattern

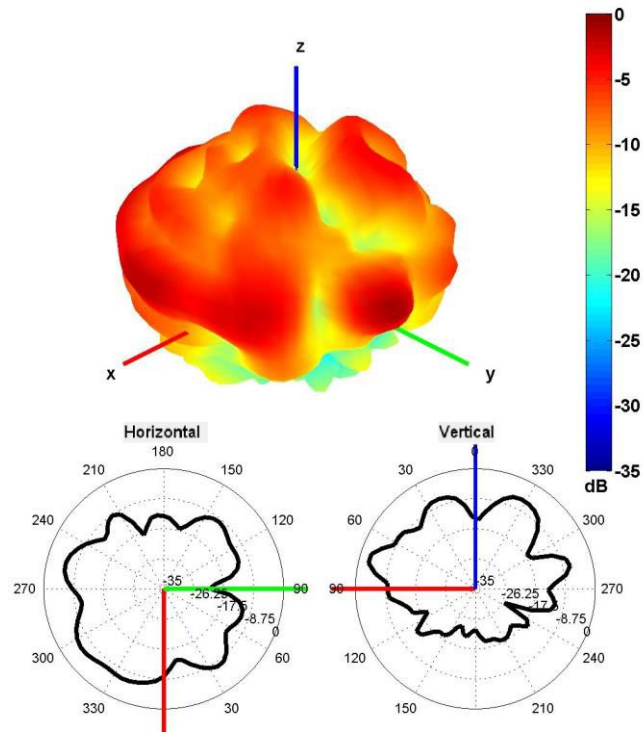

6500 MHz Radiation pattern

4. Antenna drawings

Pole Mount option using 2JB16J Bracket

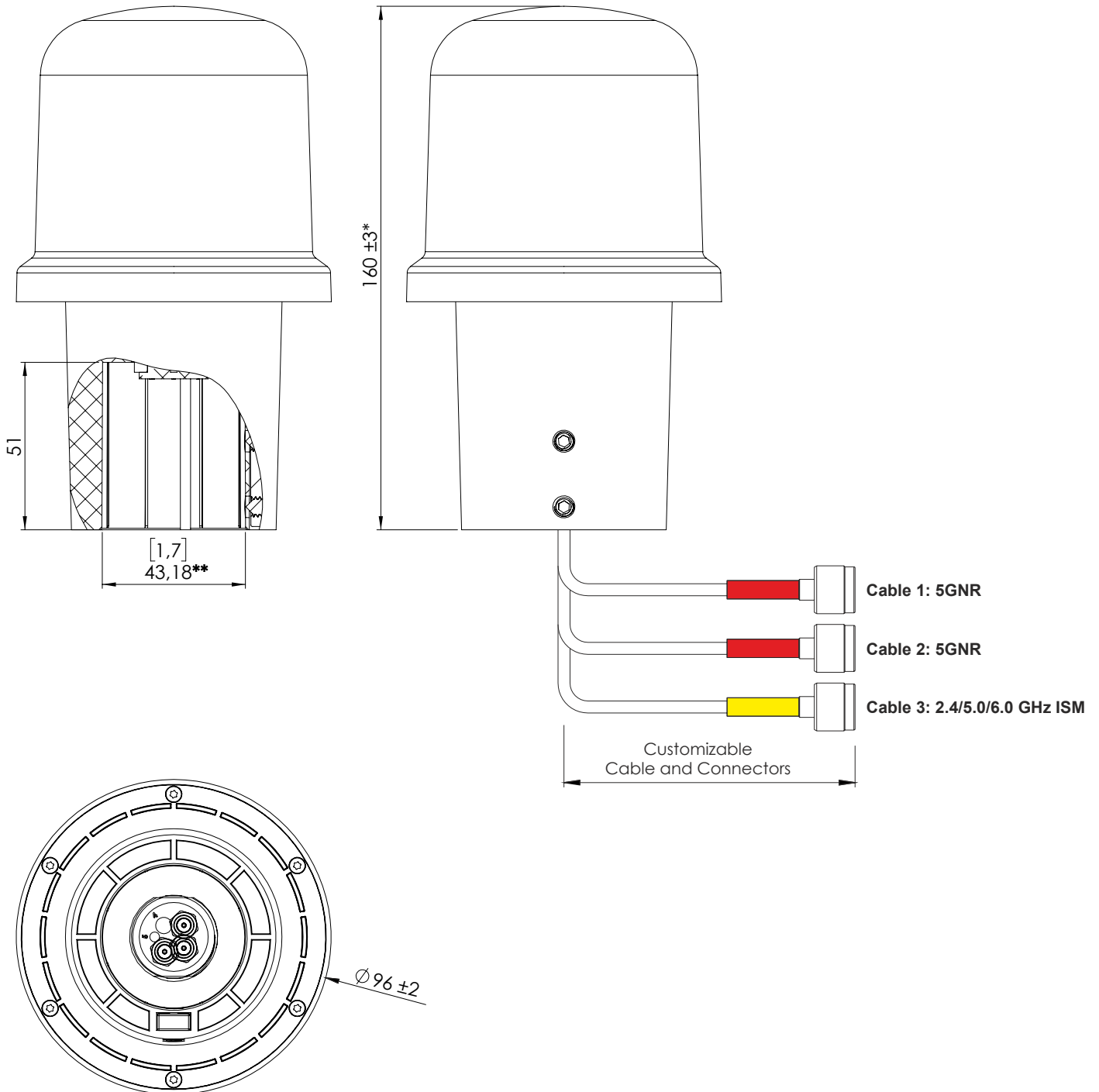

Note: Dimensions are in millimeters
 *Dimensions are after mounting
 **Mounting for pole Ø43 mm

Screw Mount option

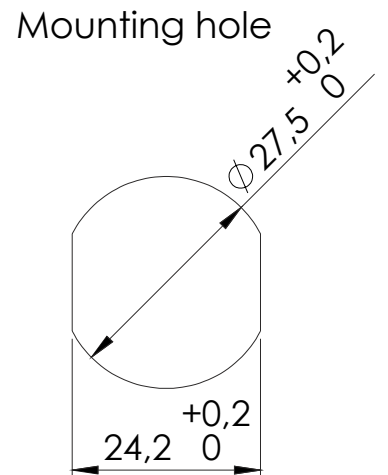
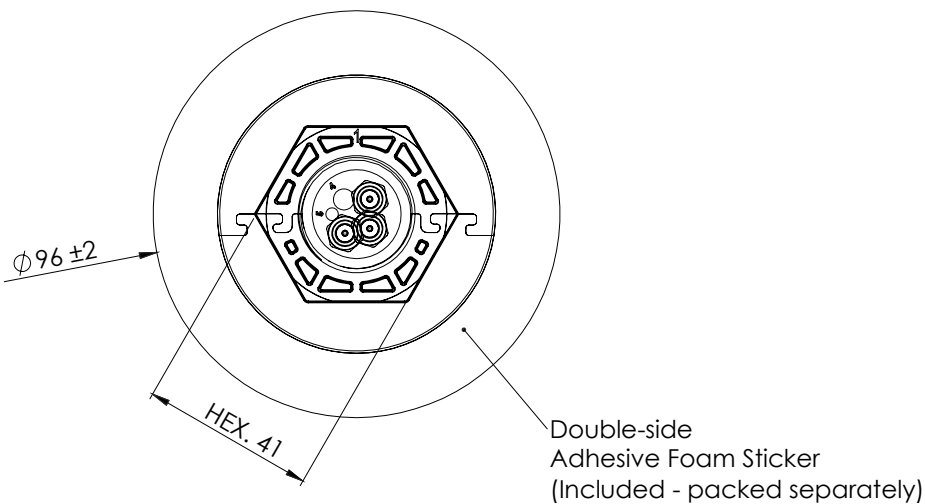
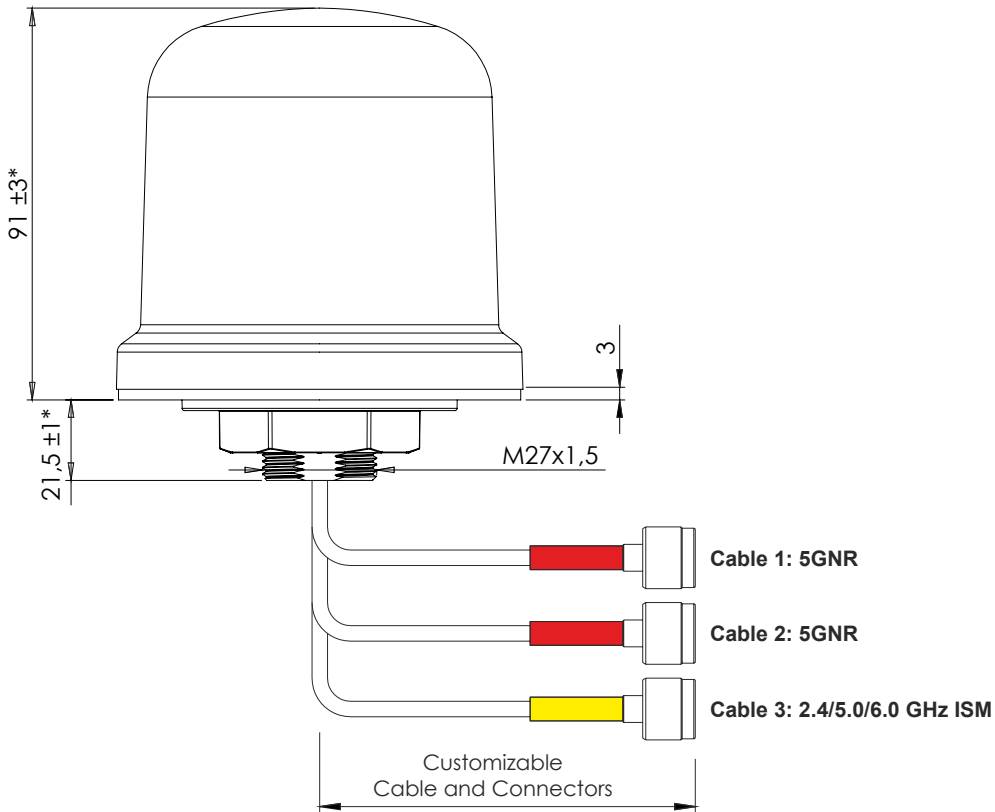

Note: Dimensions are in millimeters
***Dimensions are after mounting**
Max. mounting thickness 7mm
****Mounting Torque= 6 Nm**

5. Antenna Images

