

## Data sheet | Item number: 2020-5317/1102-950

3-conductor actuator supply terminal block; LED (yellow); for PNP-(high-side) switching actuators; with ground contact; with pluggable signal level; 1 mm<sup>2</sup>; Push-in CAGE CLAMP®; 1,00 mm<sup>2</sup>; gray

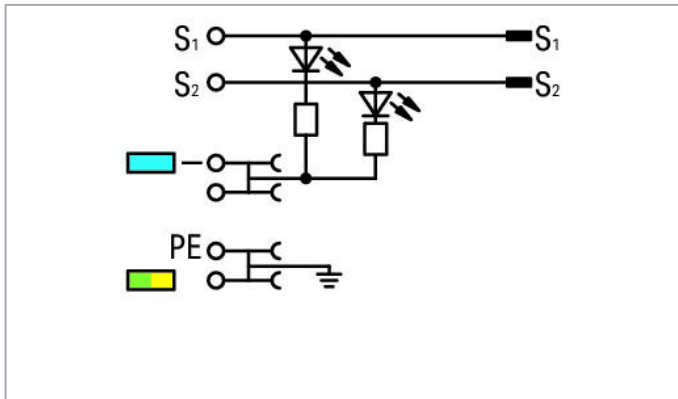

[www.wago.com/2020-5317/1102-950](http://www.wago.com/2020-5317/1102-950)

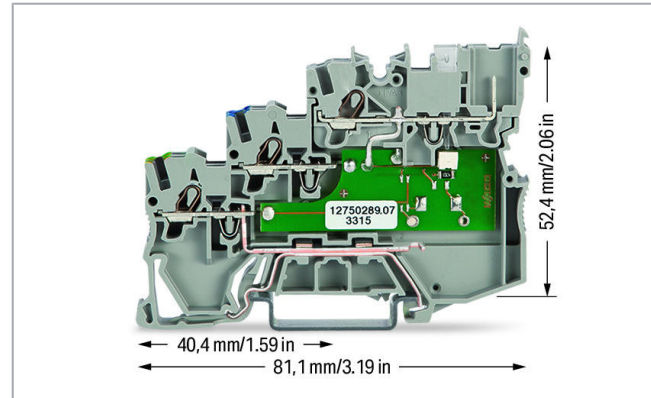
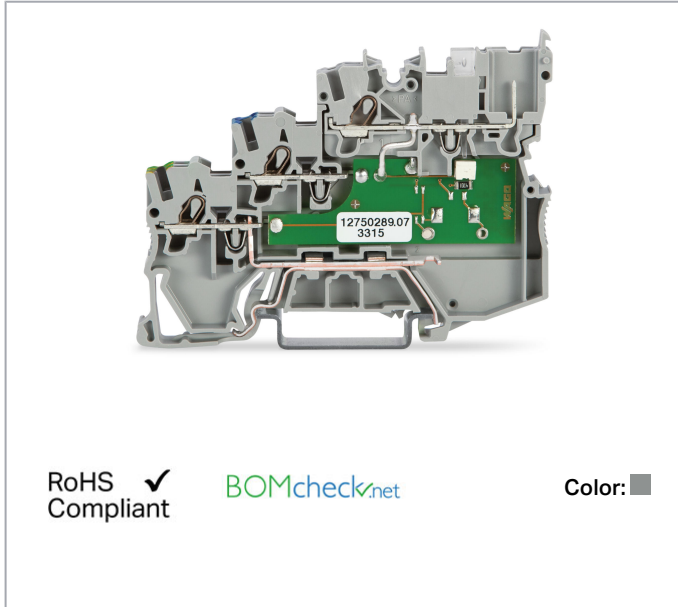

### Item description

3.5 mm spacing per signal (2 x 3.5 mm = 7 mm)

The double spacing per pole of this terminal block series maximizes connectivity. For example, ten sensors may be connected using only five sensor terminal blocks plus a power supply terminal block.

Subject to changes. Please also observe the further product documentation!

WAGO Kontakttechnik GmbH & Co. KG  
Hansastr. 27  
32423 Minden  
Phone: +49571 887-0 | Fax: +49571 887-169  
Email: [info.de@wago.com](mailto:info.de@wago.com) | Web: [www.wago.com](http://www.wago.com)

Do you have any questions about our products?  
We are always happy to take your call at +49 (571) 887-44222.



## Data

### Electrical data

Voltage type 1	DC
Nominal voltage	24 V

### Ratings per IEC/EN

Rated current	13.5 A
---------------	--------

### Ratings per UL

Approvals per	UL 1059
Rated voltage UL (Use Group B)	300 V
Rated current UL (Use Group B)	15 A
Rated voltage UL (Use Group D)	300 V
Rated current UL (Use Group D)	15 A

### Ratings per CSA

Approvals per	C22.2 No 158
Rated voltage CSA (Use Group C)	24 V
Rated current CSA (Use Group C)	10 A

### Connection data

Connection technology	Push-in CAGE CLAMP®
Actuation type	Push-in Open Tool Slot
Connectable conductor materials	Copper
Nominal cross-section	1 mm <sup>2</sup>
Solid conductor	0.14 ... 1.5 mm <sup>2</sup> / 24 ... 16 AWG
Solid conductor; push-in termination	0.5 ... 1.5 mm <sup>2</sup> / 20 ... 16 AWG
Fine-stranded conductor	0.14 ... 1.5 mm <sup>2</sup> / 24 ... 16 AWG
Fine-stranded conductor; with insulated ferrule	0.5 ... 0.75 mm <sup>2</sup> / 20 ... 18 AWG
Fine-stranded conductor; with ferrule; push-in termination	0.5 ... 0.75 mm <sup>2</sup> / 20 ... 18 AWG
Note (conductor cross-section)	Depending on the conductor characteristic, a conductor with a smaller cross-section can also be inserted via push-in termination.
Strip length	9 ... 11 mm / 0.35 ... 0.43 inch
Total number of connection points	6

Subject to changes. Please also observe the further product documentation!

WAGO Kontakttechnik GmbH & Co. KG  
 Hansastr. 27  
 32423 Minden  
 Phone: +49571 887-0 | Fax: +49571 887-169  
 Email: [info.de@wago.com](mailto:info.de@wago.com) | Web: [www.wago.com](http://www.wago.com)

Do you have any questions about our products?  
 We are always happy to take your call at +49 (571) 887-44222.

Total number of potentials	4
Number of levels	3
Wiring type	Front-entry wiring
Number of jumper slots	3

### Physical data

Width	7 mm / 0.276 inch
Height	81.1 mm / 3.193 inch

### Mechanical data

Design	horizontal type
Mounting type	DIN-35 rail
Marking level	Center/side marking

### Material data



Color	gray
Insulation material	Polyamide (PA66)
Fire load	0.012 MJ
Weight	19.3 g

### Commercial data

Packaging type	BOX
Country of origin	DE
GTIN	4055143523783
Customs tariff number	85369010000

### Approvals / Certificates

#### Country specific Approvals

Logo	Approval	Additional Approval Text	Certificate name
	CCA DEKRA Certification B.V.	EN 60947	NTR NL 7617
	CSA DEKRA Certification B.V.	C22.2 No. 158	2516073

Subject to changes. Please also observe the further product documentation!



KEMA/KEUR  
DEKRA Certification B.V.

EN 60947

71-  
100670

## UL-Approvals

Logo	Approval	Additional Approval Text	Certificate name
	UL UL International Germany GmbH	UL 1059	20171023- E45172





## Required accessories

### End plate

	Item no.: 2020-5391 End and intermediate plate; 1 mm thick; for 3-conductor terminal blocks; gray	<a href="http://www.wago.com/2020-5391">www.wago.com/2020-5391</a>
--	--	--

## Compatible products









### Female plug

	Item no.: 2020-102 1-conductor female plug; 1.5 mm <sup>2</sup> ; 2-pole; 1,50 mm <sup>2</sup> ; gray	<a href="http://www.wago.com/2020-102">www.wago.com/2020-102</a>
	Item no.: 2020-102/122-000 1-conductor female plug; Locking lever; 1.5 mm <sup>2</sup> ; 2-pole; 1,50 mm <sup>2</sup> ; gray	<a href="http://www.wago.com/2020-102/122-000">www.wago.com/2020-102/122-000</a>
	Item no.: 2020-102/132-000 1-conductor female plug; Strain relief plate; 1.5 mm <sup>2</sup> ; 2-pole; 1,50 mm <sup>2</sup> ; gray	<a href="http://www.wago.com/2020-102/132-000">www.wago.com/2020-102/132-000</a>
	Item no.: 2020-102/142-000 1-conductor female plug; Strain relief plate; 1.5 mm <sup>2</sup> ; 2-pole; 1,50 mm <sup>2</sup> ; gray	<a href="http://www.wago.com/2020-102/142-000">www.wago.com/2020-102/142-000</a>
	Item no.: 2020-103 1-conductor female plug; 1.5 mm <sup>2</sup> ; 3-pole; 1,50 mm <sup>2</sup> ; gray	<a href="http://www.wago.com/2020-103">www.wago.com/2020-103</a>
	Item no.: 2020-103/000-036 1-conductor female plug; 1.5 mm <sup>2</sup> ; 3-pole; 1,50 mm <sup>2</sup> ; gray, green-yellow	<a href="http://www.wago.com/2020-103/000-036">www.wago.com/2020-103/000-036</a>
	Item no.: 2020-103/000-037 1-conductor female plug; 1.5 mm <sup>2</sup> ; 3-pole; 1,50 mm <sup>2</sup> ; green-yellow, gray	<a href="http://www.wago.com/2020-103/000-037">www.wago.com/2020-103/000-037</a>













Subject to changes. Please also observe the further product documentation!

WAGO Kontakttechnik GmbH & Co. KG  
Hansastr. 27  
32423 Minden  
Phone: +49571 887-0 | Fax: +49571 887-169  
Email: [info.de@wago.com](mailto:info.de@wago.com) | Web: [www.wago.com](http://www.wago.com)











Do you have any questions about our products?  
We are always happy to take your call at +49 (571) 887-44222.

	<b>Item no.: 2020-103/000-038</b> 1-conductor female plug; 1.5 mm <sup>2</sup> ; 3-pole; 1,50 mm <sup>2</sup> ; gray, blue, green-yellow	<a href="http://www.wago.com/2020-103/000-038">www.wago.com/2020-103/000-038</a>
	<b>Item no.: 2020-103/000-039</b> 1-conductor female plug; 1.5 mm <sup>2</sup> ; 3-pole; 1,50 mm <sup>2</sup> ; green-yellow, blue, gray	<a href="http://www.wago.com/2020-103/000-039">www.wago.com/2020-103/000-039</a>
	<b>Item no.: 2020-103/122-000</b> 1-conductor female plug; Locking lever; 1.5 mm <sup>2</sup> ; 3-pole; 1,50 mm <sup>2</sup> ; gray	<a href="http://www.wago.com/2020-103/122-000">www.wago.com/2020-103/122-000</a>
	<b>Item no.: 2020-103/132-000</b> 1-conductor female plug; Strain relief plate; 1.5 mm <sup>2</sup> ; 3-pole; 1,50 mm <sup>2</sup> ; gray	<a href="http://www.wago.com/2020-103/132-000">www.wago.com/2020-103/132-000</a>
	<b>Item no.: 2020-103/142-000</b> 1-conductor female plug; Strain relief plate; 1.5 mm <sup>2</sup> ; 3-pole; 1,50 mm <sup>2</sup> ; gray	<a href="http://www.wago.com/2020-103/142-000">www.wago.com/2020-103/142-000</a>
	<b>Item no.: 2020-104</b> 1-conductor female plug; 1.5 mm <sup>2</sup> ; 4-pole; 1,50 mm <sup>2</sup> ; gray	<a href="http://www.wago.com/2020-104">www.wago.com/2020-104</a>
	<b>Item no.: 2020-104/000-036</b> 1-conductor female plug; 1.5 mm <sup>2</sup> ; 4-pole; 1,50 mm <sup>2</sup> ; gray, green-yellow	<a href="http://www.wago.com/2020-104/000-036">www.wago.com/2020-104/000-036</a>
	<b>Item no.: 2020-104/000-037</b> 1-conductor female plug; 1.5 mm <sup>2</sup> ; 4-pole; 1,50 mm <sup>2</sup> ; green-yellow, gray	<a href="http://www.wago.com/2020-104/000-037">www.wago.com/2020-104/000-037</a>
	<b>Item no.: 2020-104/000-038</b> 1-conductor female plug; 1.5 mm <sup>2</sup> ; 4-pole; 1,50 mm <sup>2</sup> ; gray, blue, green-yellow	<a href="http://www.wago.com/2020-104/000-038">www.wago.com/2020-104/000-038</a>
	<b>Item no.: 2020-104/000-039</b> 1-conductor female plug; 1.5 mm <sup>2</sup> ; 4-pole; 1,50 mm <sup>2</sup> ; green-yellow, blue, gray	<a href="http://www.wago.com/2020-104/000-039">www.wago.com/2020-104/000-039</a>
	<b>Item no.: 2020-104/124-000</b> 1-conductor female plug; Locking lever; 1.5 mm <sup>2</sup> ; 4-pole; 1,50 mm <sup>2</sup> ; gray	<a href="http://www.wago.com/2020-104/124-000">www.wago.com/2020-104/124-000</a>
	<b>Item no.: 2020-104/133-000</b> 1-conductor female plug; Strain relief plate; 1.5 mm <sup>2</sup> ; 4-pole; 1,50 mm <sup>2</sup> ; gray	<a href="http://www.wago.com/2020-104/133-000">www.wago.com/2020-104/133-000</a>
	<b>Item no.: 2020-104/143-000</b> 1-conductor female plug; Strain relief plate; 1.5 mm <sup>2</sup> ; 4-pole; 1,50 mm <sup>2</sup> ; gray	<a href="http://www.wago.com/2020-104/143-000">www.wago.com/2020-104/143-000</a>
	<b>Item no.: 2020-105</b> 1-conductor female plug; 1.5 mm <sup>2</sup> ; 5-pole; 1,50 mm <sup>2</sup> ; gray	<a href="http://www.wago.com/2020-105">www.wago.com/2020-105</a>









Subject to changes. Please also observe the further product documentation!

	<b>Item no.: 2020-105/000-036</b> 1-conductor female plug; 1.5 mm <sup>2</sup> ; 5-pole; 1,50 mm <sup>2</sup> ; gray, green-yellow	<a href="http://www.wago.com/2020-105/000-036">www.wago.com/2020-105/000-036</a>
	<b>Item no.: 2020-105/000-037</b> 1-conductor female plug; 1.5 mm <sup>2</sup> ; 5-pole; 1,50 mm <sup>2</sup> ; green-yellow, gray	<a href="http://www.wago.com/2020-105/000-037">www.wago.com/2020-105/000-037</a>
	<b>Item no.: 2020-105/000-038</b> 1-conductor female plug; 1.5 mm <sup>2</sup> ; 5-pole; 1,50 mm <sup>2</sup> ; gray, blue, green-yellow	<a href="http://www.wago.com/2020-105/000-038">www.wago.com/2020-105/000-038</a>
	<b>Item no.: 2020-105/000-039</b> 1-conductor female plug; 1.5 mm <sup>2</sup> ; 5-pole; 1,50 mm <sup>2</sup> ; green-yellow, blue, gray	<a href="http://www.wago.com/2020-105/000-039">www.wago.com/2020-105/000-039</a>
	<b>Item no.: 2020-105/124-000</b> 1-conductor female plug; Locking lever; 1.5 mm <sup>2</sup> ; 5-pole; 1,50 mm <sup>2</sup> ; gray	<a href="http://www.wago.com/2020-105/124-000">www.wago.com/2020-105/124-000</a>
	<b>Item no.: 2020-105/133-000</b> 1-conductor female plug; Strain relief plate; 1.5 mm <sup>2</sup> ; 5-pole; 1,50 mm <sup>2</sup> ; gray	<a href="http://www.wago.com/2020-105/133-000">www.wago.com/2020-105/133-000</a>
	<b>Item no.: 2020-105/143-000</b> 1-conductor female plug; Strain relief plate; 1.5 mm <sup>2</sup> ; 5-pole; 1,50 mm <sup>2</sup> ; gray	<a href="http://www.wago.com/2020-105/143-000">www.wago.com/2020-105/143-000</a>
	<b>Item no.: 2020-106</b> 1-conductor female plug; 1.5 mm <sup>2</sup> ; 6-pole; 1,50 mm <sup>2</sup> ; gray	<a href="http://www.wago.com/2020-106">www.wago.com/2020-106</a>
	<b>Item no.: 2020-106/000-036</b> 1-conductor female plug; 1.5 mm <sup>2</sup> ; 6-pole; 1,50 mm <sup>2</sup> ; gray, green-yellow	<a href="http://www.wago.com/2020-106/000-036">www.wago.com/2020-106/000-036</a>
	<b>Item no.: 2020-106/000-037</b> 1-conductor female plug; 1.5 mm <sup>2</sup> ; 6-pole; 1,50 mm <sup>2</sup> ; green-yellow, gray	<a href="http://www.wago.com/2020-106/000-037">www.wago.com/2020-106/000-037</a>
	<b>Item no.: 2020-106/000-038</b> 1-conductor female plug; 1.5 mm <sup>2</sup> ; 6-pole; 1,50 mm <sup>2</sup> ; gray, blue, green-yellow	<a href="http://www.wago.com/2020-106/000-038">www.wago.com/2020-106/000-038</a>
	<b>Item no.: 2020-106/000-039</b> 1-conductor female plug; 1.5 mm <sup>2</sup> ; 6-pole; 1,50 mm <sup>2</sup> ; green-yellow, blue, gray	<a href="http://www.wago.com/2020-106/000-039">www.wago.com/2020-106/000-039</a>
	<b>Item no.: 2020-106/124-000</b> 1-conductor female plug; Locking lever; 1.5 mm <sup>2</sup> ; 6-pole; 1,50 mm <sup>2</sup> ; gray	<a href="http://www.wago.com/2020-106/124-000">www.wago.com/2020-106/124-000</a>
	<b>Item no.: 2020-106/133-000</b> 1-conductor female plug; Strain relief plate; 1.5 mm <sup>2</sup> ; 6-pole; 1,50 mm <sup>2</sup> ; gray	<a href="http://www.wago.com/2020-106/133-000">www.wago.com/2020-106/133-000</a>

Subject to changes. Please also observe the further product documentation!







	<b>Item no.: 2020-106/143-000</b> 1-conductor female plug; Strain relief plate; 1.5 mm <sup>2</sup> ; 6-pole; 1,50 mm <sup>2</sup> ; gray	<a href="http://www.wago.com/2020-106/143-000">www.wago.com/2020-106/143-000</a>
	<b>Item no.: 2020-107</b> 1-conductor female plug; 1.5 mm <sup>2</sup> ; 7-pole; 1,50 mm <sup>2</sup> ; gray	<a href="http://www.wago.com/2020-107">www.wago.com/2020-107</a>
	<b>Item no.: 2020-107/000-036</b> 1-conductor female plug; 1.5 mm <sup>2</sup> ; 7-pole; 1,50 mm <sup>2</sup> ; gray, green-yellow	<a href="http://www.wago.com/2020-107/000-036">www.wago.com/2020-107/000-036</a>
	<b>Item no.: 2020-107/000-037</b> 1-conductor female plug; 1.5 mm <sup>2</sup> ; 7-pole; 1,50 mm <sup>2</sup> ; green-yellow, gray	<a href="http://www.wago.com/2020-107/000-037">www.wago.com/2020-107/000-037</a>
	<b>Item no.: 2020-107/000-038</b> 1-conductor female plug; 1.5 mm <sup>2</sup> ; 7-pole; 1,50 mm <sup>2</sup> ; gray, blue, green-yellow	<a href="http://www.wago.com/2020-107/000-038">www.wago.com/2020-107/000-038</a>
	<b>Item no.: 2020-107/000-039</b> 1-conductor female plug; 1.5 mm <sup>2</sup> ; 7-pole; 1,50 mm <sup>2</sup> ; green-yellow, blue, gray	<a href="http://www.wago.com/2020-107/000-039">www.wago.com/2020-107/000-039</a>
	<b>Item no.: 2020-107/124-000</b> 1-conductor female plug; Locking lever; 1.5 mm <sup>2</sup> ; 7-pole; 1,50 mm <sup>2</sup> ; gray	<a href="http://www.wago.com/2020-107/124-000">www.wago.com/2020-107/124-000</a>
	<b>Item no.: 2020-107/134-000</b> 1-conductor female plug; Strain relief plate; 1.5 mm <sup>2</sup> ; 7-pole; 1,50 mm <sup>2</sup> ; gray	<a href="http://www.wago.com/2020-107/134-000">www.wago.com/2020-107/134-000</a>
	<b>Item no.: 2020-107/144-000</b> 1-conductor female plug; Strain relief plate; 1.5 mm <sup>2</sup> ; 7-pole; 1,50 mm <sup>2</sup> ; gray	<a href="http://www.wago.com/2020-107/144-000">www.wago.com/2020-107/144-000</a>
	<b>Item no.: 2020-108</b> 1-conductor female plug; 1.5 mm <sup>2</sup> ; 8-pole; 1,50 mm <sup>2</sup> ; gray	<a href="http://www.wago.com/2020-108">www.wago.com/2020-108</a>
	<b>Item no.: 2020-108/000-036</b> 1-conductor female plug; 1.5 mm <sup>2</sup> ; 8-pole; 1,50 mm <sup>2</sup> ; gray, green-yellow	<a href="http://www.wago.com/2020-108/000-036">www.wago.com/2020-108/000-036</a>
	<b>Item no.: 2020-108/000-037</b> 1-conductor female plug; 1.5 mm <sup>2</sup> ; 8-pole; 1,50 mm <sup>2</sup> ; green-yellow, gray	<a href="http://www.wago.com/2020-108/000-037">www.wago.com/2020-108/000-037</a>
	<b>Item no.: 2020-108/000-038</b> 1-conductor female plug; 1.5 mm <sup>2</sup> ; 8-pole; 1,50 mm <sup>2</sup> ; gray, blue, green-yellow	<a href="http://www.wago.com/2020-108/000-038">www.wago.com/2020-108/000-038</a>
	<b>Item no.: 2020-108/000-039</b> 1-conductor female plug; 1.5 mm <sup>2</sup> ; 8-pole; 1,50 mm <sup>2</sup> ; green-yellow, blue, gray	<a href="http://www.wago.com/2020-108/000-039">www.wago.com/2020-108/000-039</a>

Subject to changes. Please also observe the further product documentation!

	<b>Item no.: 2020-108/124-000</b> 1-conductor female plug; Locking lever; 1.5 mm <sup>2</sup> ; 8-pole; 1,50 mm <sup>2</sup> ; gray	<a href="http://www.wago.com/2020-108/124-000">www.wago.com/2020-108/124-000</a>
	<b>Item no.: 2020-108/134-000</b> 1-conductor female plug; Strain relief plate; 1.5 mm <sup>2</sup> ; 8-pole; 1,50 mm <sup>2</sup> ; gray	<a href="http://www.wago.com/2020-108/134-000">www.wago.com/2020-108/134-000</a>
	<b>Item no.: 2020-108/144-000</b> 1-conductor female plug; Strain relief plate; 1.5 mm <sup>2</sup> ; 8-pole; 1,50 mm <sup>2</sup> ; gray	<a href="http://www.wago.com/2020-108/144-000">www.wago.com/2020-108/144-000</a>
	<b>Item no.: 2020-109</b> 1-conductor female plug; 1.5 mm <sup>2</sup> ; 9-pole; 1,50 mm <sup>2</sup> ; gray	<a href="http://www.wago.com/2020-109">www.wago.com/2020-109</a>
	<b>Item no.: 2020-109/000-036</b> 1-conductor female plug; 1.5 mm <sup>2</sup> ; 9-pole; 1,50 mm <sup>2</sup> ; gray, green-yellow	<a href="http://www.wago.com/2020-109/000-036">www.wago.com/2020-109/000-036</a>
	<b>Item no.: 2020-109/000-037</b> 1-conductor female plug; 1.5 mm <sup>2</sup> ; 9-pole; 1,50 mm <sup>2</sup> ; green-yellow, gray	<a href="http://www.wago.com/2020-109/000-037">www.wago.com/2020-109/000-037</a>
	<b>Item no.: 2020-109/000-038</b> 1-conductor female plug; 1.5 mm <sup>2</sup> ; 9-pole; 1,50 mm <sup>2</sup> ; gray, blue, green-yellow	<a href="http://www.wago.com/2020-109/000-038">www.wago.com/2020-109/000-038</a>
	<b>Item no.: 2020-109/000-039</b> 1-conductor female plug; 1.5 mm <sup>2</sup> ; 9-pole; 1,50 mm <sup>2</sup> ; green-yellow, blue, gray	<a href="http://www.wago.com/2020-109/000-039">www.wago.com/2020-109/000-039</a>
	<b>Item no.: 2020-109/124-000</b> 1-conductor female plug; Locking lever; 1.5 mm <sup>2</sup> ; 9-pole; 1,50 mm <sup>2</sup> ; gray	<a href="http://www.wago.com/2020-109/124-000">www.wago.com/2020-109/124-000</a>
	<b>Item no.: 2020-109/134-000</b> 1-conductor female plug; Strain relief plate; 1.5 mm <sup>2</sup> ; 9-pole; 1,50 mm <sup>2</sup> ; gray	<a href="http://www.wago.com/2020-109/134-000">www.wago.com/2020-109/134-000</a>
	<b>Item no.: 2020-109/144-000</b> 1-conductor female plug; Strain relief plate; 1.5 mm <sup>2</sup> ; 9-pole; 1,50 mm <sup>2</sup> ; gray	<a href="http://www.wago.com/2020-109/144-000">www.wago.com/2020-109/144-000</a>
	<b>Item no.: 2020-110</b> 1-conductor female plug; 1.5 mm <sup>2</sup> ; 10-pole; 1,50 mm <sup>2</sup> ; gray	<a href="http://www.wago.com/2020-110">www.wago.com/2020-110</a>
	<b>Item no.: 2020-110/000-036</b> 1-conductor female plug; 1.5 mm <sup>2</sup> ; 10-pole; 1,50 mm <sup>2</sup> ; gray, green-yellow	<a href="http://www.wago.com/2020-110/000-036">www.wago.com/2020-110/000-036</a>
	<b>Item no.: 2020-110/000-037</b> 1-conductor female plug; 1.5 mm <sup>2</sup> ; 10-pole; 1,50 mm <sup>2</sup> ; green-yellow, gray	<a href="http://www.wago.com/2020-110/000-037">www.wago.com/2020-110/000-037</a>

Subject to changes. Please also observe the further product documentation!



	<p><b>Item no.: 2020-110/000-038</b> 1-conductor female plug; 1.5 mm<sup>2</sup>; 10-pole; 1,50 mm<sup>2</sup>; gray, blue, green-yellow</p>	<a href="http://www.wago.com/2020-110/000-038">www.wago.com/2020-110/000-038</a>
	<p><b>Item no.: 2020-110/000-039</b> 1-conductor female plug; 1.5 mm<sup>2</sup>; 10-pole; 1,50 mm<sup>2</sup>; green-yellow, blue, gray</p>	<a href="http://www.wago.com/2020-110/000-039">www.wago.com/2020-110/000-039</a>
	<p><b>Item no.: 2020-110/125-000</b> 1-conductor female plug; Locking lever; 1.5 mm<sup>2</sup>; 10-pole; 1,50 mm<sup>2</sup>; gray</p>	<a href="http://www.wago.com/2020-110/125-000">www.wago.com/2020-110/125-000</a>
	<p><b>Item no.: 2020-110/135-000</b> 1-conductor female plug; Strain relief plate; 1.5 mm<sup>2</sup>; 10-pole; 1,50 mm<sup>2</sup>; gray</p>	<a href="http://www.wago.com/2020-110/135-000">www.wago.com/2020-110/135-000</a>
	<p><b>Item no.: 2020-110/145-000</b> 1-conductor female plug; Strain relief plate; 1.5 mm<sup>2</sup>; 10-pole; 1,50 mm<sup>2</sup>; gray</p>	<a href="http://www.wago.com/2020-110/145-000">www.wago.com/2020-110/145-000</a>
	<p><b>Item no.: 2020-111</b> 1-conductor female plug; 1.5 mm<sup>2</sup>; 11-pole; 1,50 mm<sup>2</sup>; gray</p>	<a href="http://www.wago.com/2020-111">www.wago.com/2020-111</a>
	<p><b>Item no.: 2020-111/000-036</b> 1-conductor female plug; 1.5 mm<sup>2</sup>; 11-pole; 1,50 mm<sup>2</sup>; gray, green-yellow</p>	<a href="http://www.wago.com/2020-111/000-036">www.wago.com/2020-111/000-036</a>
	<p><b>Item no.: 2020-111/000-037</b> 1-conductor female plug; 1.5 mm<sup>2</sup>; 11-pole; 1,50 mm<sup>2</sup>; green-yellow, gray</p>	<a href="http://www.wago.com/2020-111/000-037">www.wago.com/2020-111/000-037</a>
	<p><b>Item no.: 2020-111/000-038</b> 1-conductor female plug; 1.5 mm<sup>2</sup>; 11-pole; 1,50 mm<sup>2</sup>; gray, blue, green-yellow</p>	<a href="http://www.wago.com/2020-111/000-038">www.wago.com/2020-111/000-038</a>
	<p><b>Item no.: 2020-111/000-039</b> 1-conductor female plug; 1.5 mm<sup>2</sup>; 11-pole; 1,50 mm<sup>2</sup>; green-yellow, blue, gray</p>	<a href="http://www.wago.com/2020-111/000-039">www.wago.com/2020-111/000-039</a>
	<p><b>Item no.: 2020-111/125-000</b> 1-conductor female plug; Locking lever; 1.5 mm<sup>2</sup>; 11-pole; 1,50 mm<sup>2</sup>; gray</p>	<a href="http://www.wago.com/2020-111/125-000">www.wago.com/2020-111/125-000</a>
	<p><b>Item no.: 2020-111/135-000</b> 1-conductor female plug; Strain relief plate; 1.5 mm<sup>2</sup>; 11-pole; 1,50 mm<sup>2</sup>; gray</p>	<a href="http://www.wago.com/2020-111/135-000">www.wago.com/2020-111/135-000</a>
	<p><b>Item no.: 2020-111/145-000</b> 1-conductor female plug; Strain relief plate; 1.5 mm<sup>2</sup>; 11-pole; 1,50 mm<sup>2</sup>; gray</p>	<a href="http://www.wago.com/2020-111/145-000">www.wago.com/2020-111/145-000</a>

Subject to changes. Please also observe the further product documentation!



**Item no.: 2020-112**

1-conductor female plug; 1.5 mm<sup>2</sup>; 12-pole; 1,50 mm<sup>2</sup>; gray

[www.wago.com/2020-112](http://www.wago.com/2020-112)



**Item no.: 2020-112/000-036**

1-conductor female plug; 1.5 mm<sup>2</sup>; 12-pole; 1,50 mm<sup>2</sup>; gray, green-yellow

[www.wago.com/2020-112/000-036](http://www.wago.com/2020-112/000-036)



**Item no.: 2020-112/000-037**

1-conductor female plug; 1.5 mm<sup>2</sup>; 12-pole; 1,50 mm<sup>2</sup>; green-yellow, gray

[www.wago.com/2020-112/000-037](http://www.wago.com/2020-112/000-037)



**Item no.: 2020-112/000-038**

1-conductor female plug; 1.5 mm<sup>2</sup>; 12-pole; 1,50 mm<sup>2</sup>; gray, blue, green-yellow

[www.wago.com/2020-112/000-038](http://www.wago.com/2020-112/000-038)



**Item no.: 2020-112/000-039**

1-conductor female plug; 1.5 mm<sup>2</sup>; 12-pole; 1,50 mm<sup>2</sup>; green-yellow, blue, gray

[www.wago.com/2020-112/000-039](http://www.wago.com/2020-112/000-039)

**Item no.: 2020-112/125-000**

1-conductor female plug; Locking lever; 1.5 mm<sup>2</sup>; 12-pole; 1,50 mm<sup>2</sup>; gray

[www.wago.com/2020-112/125-000](http://www.wago.com/2020-112/125-000)

**Item no.: 2020-112/135-000**

1-conductor female plug; Strain relief plate; 1.5 mm<sup>2</sup>; 12-pole; 1,50 mm<sup>2</sup>; gray

[www.wago.com/2020-112/135-000](http://www.wago.com/2020-112/135-000)

**Item no.: 2020-112/145-000**

1-conductor female plug; Strain relief plate; 1.5 mm<sup>2</sup>; 12-pole; 1,50 mm<sup>2</sup>; gray

[www.wago.com/2020-112/145-000](http://www.wago.com/2020-112/145-000)



**Item no.: 2020-113**

1-conductor female plug; 1.5 mm<sup>2</sup>; 13-pole; 1,50 mm<sup>2</sup>; gray

[www.wago.com/2020-113](http://www.wago.com/2020-113)



**Item no.: 2020-113/000-036**

1-conductor female plug; 1.5 mm<sup>2</sup>; 13-pole; 1,50 mm<sup>2</sup>; gray, green-yellow

[www.wago.com/2020-113/000-036](http://www.wago.com/2020-113/000-036)



**Item no.: 2020-113/000-037**

1-conductor female plug; 1.5 mm<sup>2</sup>; 13-pole; 1,50 mm<sup>2</sup>; green-yellow, gray

[www.wago.com/2020-113/000-037](http://www.wago.com/2020-113/000-037)



**Item no.: 2020-113/000-038**

1-conductor female plug; 1.5 mm<sup>2</sup>; 13-pole; 1,50 mm<sup>2</sup>; gray, blue, green-yellow

[www.wago.com/2020-113/000-038](http://www.wago.com/2020-113/000-038)



**Item no.: 2020-113/000-039**

1-conductor female plug; 1.5 mm<sup>2</sup>; 13-pole; 1,50 mm<sup>2</sup>; green-yellow, blue, gray

[www.wago.com/2020-113/000-039](http://www.wago.com/2020-113/000-039)

**Item no.: 2020-113/125-000**

1-conductor female plug; Locking lever; 1.5 mm<sup>2</sup>; 13-pole; 1,50 mm<sup>2</sup>; gray

[www.wago.com/2020-113/125-000](http://www.wago.com/2020-113/125-000)

Subject to changes. Please also observe the further product documentation!

WAGO Kontakttechnik GmbH & Co. KG

Hansastr. 27









32423 Minden

Phone: +49571 887-0 | Fax: +49571 887-169

Email: [info.de@wago.com](mailto:info.de@wago.com) | Web: [www.wago.com](http://www.wago.com)

Do you have any questions about our products?

We are always happy to take your call at +49 (571) 887-44222.

	<p><b>Item no.: 2020-113/135-000</b> 1-conductor female plug; Strain relief plate; 1.5 mm<sup>2</sup>; 13-pole; 1,50 mm<sup>2</sup>; gray</p>	<p><a href="http://www.wago.com/2020-113/135-000">www.wago.com/2020-113/135-000</a></p>
	<p><b>Item no.: 2020-113/145-000</b> 1-conductor female plug; Strain relief plate; 1.5 mm<sup>2</sup>; 13-pole; 1,50 mm<sup>2</sup>; gray</p>	<p><a href="http://www.wago.com/2020-113/145-000">www.wago.com/2020-113/145-000</a></p>
	<p><b>Item no.: 2020-114</b> 1-conductor female plug; 1.5 mm<sup>2</sup>; 14-pole; 1,50 mm<sup>2</sup>; gray</p>	<p><a href="http://www.wago.com/2020-114">www.wago.com/2020-114</a></p>
	<p><b>Item no.: 2020-114/000-036</b> 1-conductor female plug; 1.5 mm<sup>2</sup>; 14-pole; 1,50 mm<sup>2</sup>; gray, green-yellow</p>	<p><a href="http://www.wago.com/2020-114/000-036">www.wago.com/2020-114/000-036</a></p>
	<p><b>Item no.: 2020-114/000-037</b> 1-conductor female plug; 1.5 mm<sup>2</sup>; 14-pole; 1,50 mm<sup>2</sup>; green-yellow, gray</p>	<p><a href="http://www.wago.com/2020-114/000-037">www.wago.com/2020-114/000-037</a></p>
	<p><b>Item no.: 2020-114/000-038</b> 1-conductor female plug; 1.5 mm<sup>2</sup>; 14-pole; 1,50 mm<sup>2</sup>; gray, blue, green-yellow</p>	<p><a href="http://www.wago.com/2020-114/000-038">www.wago.com/2020-114/000-038</a></p>
	<p><b>Item no.: 2020-114/000-039</b> 1-conductor female plug; 1.5 mm<sup>2</sup>; 14-pole; 1,50 mm<sup>2</sup>; green-yellow, blue, gray</p>	<p><a href="http://www.wago.com/2020-114/000-039">www.wago.com/2020-114/000-039</a></p>
	<p><b>Item no.: 2020-114/125-000</b> 1-conductor female plug; Locking lever; 1.5 mm<sup>2</sup>; 14-pole; 1,50 mm<sup>2</sup>; gray</p>	<p><a href="http://www.wago.com/2020-114/125-000">www.wago.com/2020-114/125-000</a></p>
	<p><b>Item no.: 2020-114/135-000</b> 1-conductor female plug; Strain relief plate; 1.5 mm<sup>2</sup>; 14-pole; 1,50 mm<sup>2</sup>; gray</p>	<p><a href="http://www.wago.com/2020-114/135-000">www.wago.com/2020-114/135-000</a></p>
	<p><b>Item no.: 2020-114/145-000</b> 1-conductor female plug; Strain relief plate; 1.5 mm<sup>2</sup>; 14-pole; 1,50 mm<sup>2</sup>; gray</p>	<p><a href="http://www.wago.com/2020-114/145-000">www.wago.com/2020-114/145-000</a></p>
	<p><b>Item no.: 2020-115</b> 1-conductor female plug; 1.5 mm<sup>2</sup>; 15-pole; 1,50 mm<sup>2</sup>; gray</p>	<p><a href="http://www.wago.com/2020-115">www.wago.com/2020-115</a></p>
	<p><b>Item no.: 2020-115/000-036</b> 1-conductor female plug; 1.5 mm<sup>2</sup>; 15-pole; 1,50 mm<sup>2</sup>; gray, green-yellow</p>	<p><a href="http://www.wago.com/2020-115/000-036">www.wago.com/2020-115/000-036</a></p>
	<p><b>Item no.: 2020-115/000-037</b> 1-conductor female plug; 1.5 mm<sup>2</sup>; 15-pole; 1,50 mm<sup>2</sup>; green-yellow, gray</p>	<p><a href="http://www.wago.com/2020-115/000-037">www.wago.com/2020-115/000-037</a></p>
	<p><b>Item no.: 2020-115/000-038</b> 1-conductor female plug; 1.5 mm<sup>2</sup>; 15-pole; 1,50 mm<sup>2</sup>; gray, blue, green-yellow</p>	<p><a href="http://www.wago.com/2020-115/000-038">www.wago.com/2020-115/000-038</a></p>

Subject to changes. Please also observe the further product documentation!



**Item no.: 2020-115/000-039**

1-conductor female plug; 1.5 mm<sup>2</sup>; 15-pole; 1,50 mm<sup>2</sup>; green-yellow, blue, gray

[www.wago.com/2020-115/000-039](http://www.wago.com/2020-115/000-039)

**Item no.: 2020-115/125-000**

1-conductor female plug; Locking lever; 1.5 mm<sup>2</sup>; 15-pole; 1,50 mm<sup>2</sup>; gray

[www.wago.com/2020-115/125-000](http://www.wago.com/2020-115/125-000)

**Item no.: 2020-115/135-000**

1-conductor female plug; Strain relief plate; 1.5 mm<sup>2</sup>; 15-pole; 1,50 mm<sup>2</sup>; gray

[www.wago.com/2020-115/135-000](http://www.wago.com/2020-115/135-000)

**Item no.: 2020-115/145-000**

1-conductor female plug; Strain relief plate; 1.5 mm<sup>2</sup>; 15-pole; 1,50 mm<sup>2</sup>; gray

[www.wago.com/2020-115/145-000](http://www.wago.com/2020-115/145-000)



**Item no.: 2020-161**

Start module for 1-conductor female connector; with integrated end plate; 1.5 mm<sup>2</sup>; 1-pole; 1,50 mm<sup>2</sup>; gray

[www.wago.com/2020-161](http://www.wago.com/2020-161)



**Item no.: 2020-164**

Start module for 1-conductor female connector; with integrated end plate; 1.5 mm<sup>2</sup>; 1-pole; 1,50 mm<sup>2</sup>; blue

[www.wago.com/2020-164](http://www.wago.com/2020-164)



**Item no.: 2020-167**

Start module for 1-conductor female connector; 1.5 mm<sup>2</sup>; 1-pole; 1,50 mm<sup>2</sup>; green-yellow

[www.wago.com/2020-167](http://www.wago.com/2020-167)



**Item no.: 2020-181**

End module for 1-conductor female connector; 1.5 mm<sup>2</sup>; 1-pole; 1,50 mm<sup>2</sup>; gray

[www.wago.com/2020-181](http://www.wago.com/2020-181)



**Item no.: 2020-184**

End module for 1-conductor female connector; 1.5 mm<sup>2</sup>; 1-pole; 1,50 mm<sup>2</sup>; blue

[www.wago.com/2020-184](http://www.wago.com/2020-184)



**Item no.: 2020-187**

End module for 1-conductor female connector; 1.5 mm<sup>2</sup>; 1-pole; 1,50 mm<sup>2</sup>; green-yellow

[www.wago.com/2020-187](http://www.wago.com/2020-187)



**Item no.: 2020-202**

2-conductor female connector; 1.5 mm<sup>2</sup>; 2-pole; 1,50 mm<sup>2</sup>; gray

[www.wago.com/2020-202](http://www.wago.com/2020-202)



**Item no.: 2020-203**

2-conductor female connector; 1.5 mm<sup>2</sup>; 3-pole; 1,50 mm<sup>2</sup>; gray

[www.wago.com/2020-203](http://www.wago.com/2020-203)



**Item no.: 2020-203/000-036**

2-conductor female connector; 1.5 mm<sup>2</sup>; 3-pole; 1,50 mm<sup>2</sup>; gray, green-yellow

[www.wago.com/2020-203/000-036](http://www.wago.com/2020-203/000-036)



**Item no.: 2020-203/000-037**

2-conductor female connector; 1.5 mm<sup>2</sup>; 3-pole; 1,50 mm<sup>2</sup>; green-yellow, gray

[www.wago.com/2020-203/000-037](http://www.wago.com/2020-203/000-037)



**Item no.: 2020-203/000-038**

2-conductor female connector; 1.5 mm<sup>2</sup>; 3-pole; 1,50 mm<sup>2</sup>; gray, blue, green-yellow

[www.wago.com/2020-203/000-038](http://www.wago.com/2020-203/000-038)

Subject to changes. Please also observe the further product documentation!

WAGO Kontakttechnik GmbH & Co. KG

Hansastr. 27















32423 Minden

Phone: +49571 887-0 | Fax: +49571 887-169

Email: [info.de@wago.com](mailto:info.de@wago.com) | Web: [www.wago.com](http://www.wago.com)

Do you have any questions about our products?

We are always happy to take your call at +49 (571) 887-44222.

	<b>Item no.: 2020-203/000-039</b> 2-conductor female connector; 1.5 mm <sup>2</sup> ; 3-pole; 1,50 mm <sup>2</sup> ; green-yellow, blue, gray	<a href="http://www.wago.com/2020-203/000-039">www.wago.com/2020-203/000-039</a>
	<b>Item no.: 2020-204</b> 2-conductor female connector; 1.5 mm <sup>2</sup> ; 4-pole; 1,50 mm <sup>2</sup> ; gray	<a href="http://www.wago.com/2020-204">www.wago.com/2020-204</a>
	<b>Item no.: 2020-204/000-036</b> 2-conductor female connector; 1.5 mm <sup>2</sup> ; 4-pole; 1,50 mm <sup>2</sup> ; gray, green-yellow	<a href="http://www.wago.com/2020-204/000-036">www.wago.com/2020-204/000-036</a>
	<b>Item no.: 2020-204/000-037</b> 2-conductor female connector; 1.5 mm <sup>2</sup> ; 4-pole; 1,50 mm <sup>2</sup> ; green-yellow, gray	<a href="http://www.wago.com/2020-204/000-037">www.wago.com/2020-204/000-037</a>
	<b>Item no.: 2020-204/000-038</b> 2-conductor female connector; 1.5 mm <sup>2</sup> ; 4-pole; 1,50 mm <sup>2</sup> ; gray, blue, green-yellow	<a href="http://www.wago.com/2020-204/000-038">www.wago.com/2020-204/000-038</a>
	<b>Item no.: 2020-204/000-039</b> 2-conductor female connector; 1.5 mm <sup>2</sup> ; 4-pole; 1,50 mm <sup>2</sup> ; green-yellow, blue, gray	<a href="http://www.wago.com/2020-204/000-039">www.wago.com/2020-204/000-039</a>
	<b>Item no.: 2020-205</b> 2-conductor female connector; 1.5 mm <sup>2</sup> ; 5-pole; 1,50 mm <sup>2</sup> ; gray	<a href="http://www.wago.com/2020-205">www.wago.com/2020-205</a>
	<b>Item no.: 2020-205/000-036</b> 2-conductor female connector; 1.5 mm <sup>2</sup> ; 5-pole; 1,50 mm <sup>2</sup> ; gray, green-yellow	<a href="http://www.wago.com/2020-205/000-036">www.wago.com/2020-205/000-036</a>
	<b>Item no.: 2020-205/000-037</b> 2-conductor female connector; 1.5 mm <sup>2</sup> ; 5-pole; 1,50 mm <sup>2</sup> ; green-yellow, gray	<a href="http://www.wago.com/2020-205/000-037">www.wago.com/2020-205/000-037</a>
	<b>Item no.: 2020-205/000-038</b> 2-conductor female connector; 1.5 mm <sup>2</sup> ; 5-pole; 1,50 mm <sup>2</sup> ; gray, blue, green-yellow	<a href="http://www.wago.com/2020-205/000-038">www.wago.com/2020-205/000-038</a>
	<b>Item no.: 2020-205/000-039</b> 2-conductor female connector; 1.5 mm <sup>2</sup> ; 5-pole; 1,50 mm <sup>2</sup> ; green-yellow, blue, gray	<a href="http://www.wago.com/2020-205/000-039">www.wago.com/2020-205/000-039</a>
	<b>Item no.: 2020-206</b> 2-conductor female connector; 1.5 mm <sup>2</sup> ; 6-pole; 1,50 mm <sup>2</sup> ; gray	<a href="http://www.wago.com/2020-206">www.wago.com/2020-206</a>
	<b>Item no.: 2020-206/000-036</b> 2-conductor female connector; 1.5 mm <sup>2</sup> ; 6-pole; 1,50 mm <sup>2</sup> ; gray, green-yellow	<a href="http://www.wago.com/2020-206/000-036">www.wago.com/2020-206/000-036</a>
	<b>Item no.: 2020-206/000-037</b> 2-conductor female connector; 1.5 mm <sup>2</sup> ; 6-pole; 1,50 mm <sup>2</sup> ; green-yellow, gray	<a href="http://www.wago.com/2020-206/000-037">www.wago.com/2020-206/000-037</a>

Subject to changes. Please also observe the further product documentation!



**Item no.: 2020-206/000-038**

2-conductor female connector; 1.5 mm<sup>2</sup>; 6-pole; 1,50 mm<sup>2</sup>; gray, blue, green-yellow

[www.wago.com/2020-206/000-038](http://www.wago.com/2020-206/000-038)



**Item no.: 2020-206/000-039**

2-conductor female connector; 1.5 mm<sup>2</sup>; 6-pole; 1,50 mm<sup>2</sup>; green-yellow, blue, gray

[www.wago.com/2020-206/000-039](http://www.wago.com/2020-206/000-039)



**Item no.: 2020-207**

2-conductor female connector; 1.5 mm<sup>2</sup>; 7-pole; 1,50 mm<sup>2</sup>; gray

[www.wago.com/2020-207](http://www.wago.com/2020-207)



**Item no.: 2020-207/000-036**

2-conductor female connector; 1.5 mm<sup>2</sup>; 7-pole; 1,50 mm<sup>2</sup>; gray, green-yellow

[www.wago.com/2020-207/000-036](http://www.wago.com/2020-207/000-036)



**Item no.: 2020-207/000-037**

2-conductor female connector; 1.5 mm<sup>2</sup>; 7-pole; 1,50 mm<sup>2</sup>; green-yellow, gray

[www.wago.com/2020-207/000-037](http://www.wago.com/2020-207/000-037)



**Item no.: 2020-207/000-038**

2-conductor female connector; 1.5 mm<sup>2</sup>; 7-pole; 1,50 mm<sup>2</sup>; gray, blue, green-yellow

[www.wago.com/2020-207/000-038](http://www.wago.com/2020-207/000-038)



**Item no.: 2020-207/000-039**

2-conductor female connector; 1.5 mm<sup>2</sup>; 7-pole; 1,50 mm<sup>2</sup>; green-yellow, blue, gray

[www.wago.com/2020-207/000-039](http://www.wago.com/2020-207/000-039)



**Item no.: 2020-208**

2-conductor female connector; 1.5 mm<sup>2</sup>; 8-pole; 1,50 mm<sup>2</sup>; gray

[www.wago.com/2020-208](http://www.wago.com/2020-208)



**Item no.: 2020-208/000-036**

2-conductor female connector; 1.5 mm<sup>2</sup>; 8-pole; 1,50 mm<sup>2</sup>; gray, green-yellow

[www.wago.com/2020-208/000-036](http://www.wago.com/2020-208/000-036)



**Item no.: 2020-208/000-037**

2-conductor female connector; 1.5 mm<sup>2</sup>; 8-pole; 1,50 mm<sup>2</sup>; green-yellow, gray

[www.wago.com/2020-208/000-037](http://www.wago.com/2020-208/000-037)



**Item no.: 2020-208/000-038**

2-conductor female connector; 1.5 mm<sup>2</sup>; 8-pole; 1,50 mm<sup>2</sup>; gray, blue, green-yellow

[www.wago.com/2020-208/000-038](http://www.wago.com/2020-208/000-038)



**Item no.: 2020-208/000-039**

2-conductor female connector; 1.5 mm<sup>2</sup>; 8-pole; 1,50 mm<sup>2</sup>; green-yellow, blue, gray

[www.wago.com/2020-208/000-039](http://www.wago.com/2020-208/000-039)



**Item no.: 2020-209**

2-conductor female connector; 1.5 mm<sup>2</sup>; 9-pole; 1,50 mm<sup>2</sup>; gray

[www.wago.com/2020-209](http://www.wago.com/2020-209)



**Item no.: 2020-209/000-036**

2-conductor female connector; 1.5 mm<sup>2</sup>; 9-pole; 1,50 mm<sup>2</sup>; gray, green-yellow

[www.wago.com/2020-209/000-036](http://www.wago.com/2020-209/000-036)

Subject to changes. Please also observe the further product documentation!

WAGO Kontakttechnik GmbH & Co. KG

Hansastr. 27

32423 Minden

Phone: +49571 887-0 | Fax: +49571 887-169

Email: [info.de@wago.com](mailto:info.de@wago.com) | Web: [www.wago.com](http://www.wago.com)

Do you have any questions about our products?

We are always happy to take your call at +49 (571) 887-44222.



**Item no.: 2020-209/000-037**  
2-conductor female connector; 1.5 mm<sup>2</sup>; 9-pole; 1,50 mm<sup>2</sup>; green-yellow, gray

[www.wago.com/2020-209/000-037](http://www.wago.com/2020-209/000-037)



**Item no.: 2020-209/000-038**  
2-conductor female connector; 1.5 mm<sup>2</sup>; 9-pole; 1,50 mm<sup>2</sup>; gray, blue, green-yellow

[www.wago.com/2020-209/000-038](http://www.wago.com/2020-209/000-038)



**Item no.: 2020-209/000-039**  
2-conductor female connector; 1.5 mm<sup>2</sup>; 9-pole; 1,50 mm<sup>2</sup>; green-yellow, blue, gray

[www.wago.com/2020-209/000-039](http://www.wago.com/2020-209/000-039)



**Item no.: 2020-210**  
2-conductor female connector; 1.5 mm<sup>2</sup>; 10-pole; 1,50 mm<sup>2</sup>; gray

[www.wago.com/2020-210](http://www.wago.com/2020-210)



**Item no.: 2020-210/000-036**  
2-conductor female connector; 1.5 mm<sup>2</sup>; 10-pole; 1,50 mm<sup>2</sup>; gray, green-yellow

[www.wago.com/2020-210/000-036](http://www.wago.com/2020-210/000-036)



**Item no.: 2020-210/000-037**  
2-conductor female connector; 1.5 mm<sup>2</sup>; 10-pole; 1,50 mm<sup>2</sup>; green-yellow, gray

[www.wago.com/2020-210/000-037](http://www.wago.com/2020-210/000-037)



**Item no.: 2020-210/000-038**  
2-conductor female connector; 1.5 mm<sup>2</sup>; 10-pole; 1,50 mm<sup>2</sup>; gray, blue, green-yellow

[www.wago.com/2020-210/000-038](http://www.wago.com/2020-210/000-038)



**Item no.: 2020-210/000-039**  
2-conductor female connector; 1.5 mm<sup>2</sup>; 10-pole; 1,50 mm<sup>2</sup>; green-yellow, blue, gray

[www.wago.com/2020-210/000-039](http://www.wago.com/2020-210/000-039)



**Item no.: 2020-211**  
2-conductor female connector; 1.5 mm<sup>2</sup>; 11-pole; 1,50 mm<sup>2</sup>; gray

[www.wago.com/2020-211](http://www.wago.com/2020-211)



**Item no.: 2020-211/000-036**  
2-conductor female connector; 1.5 mm<sup>2</sup>; 11-pole; 1,50 mm<sup>2</sup>; gray, green-yellow

[www.wago.com/2020-211/000-036](http://www.wago.com/2020-211/000-036)



**Item no.: 2020-211/000-037**  
2-conductor female connector; 1.5 mm<sup>2</sup>; 11-pole; 1,50 mm<sup>2</sup>; green-yellow, gray

[www.wago.com/2020-211/000-037](http://www.wago.com/2020-211/000-037)



**Item no.: 2020-211/000-038**  
2-conductor female connector; 1.5 mm<sup>2</sup>; 11-pole; 1,50 mm<sup>2</sup>; gray, blue, green-yellow

[www.wago.com/2020-211/000-038](http://www.wago.com/2020-211/000-038)



**Item no.: 2020-211/000-039**  
2-conductor female connector; 1.5 mm<sup>2</sup>; 11-pole; 1,50 mm<sup>2</sup>; green-yellow, blue, gray

[www.wago.com/2020-211/000-039](http://www.wago.com/2020-211/000-039)



**Item no.: 2020-212**  
2-conductor female connector; 1.5 mm<sup>2</sup>; 12-pole; 1,50 mm<sup>2</sup>; gray

[www.wago.com/2020-212](http://www.wago.com/2020-212)

Subject to changes. Please also observe the further product documentation!



**Item no.: 2020-212/000-036**

2-conductor female connector; 1.5 mm<sup>2</sup>; 12-pole; 1,50 mm<sup>2</sup>; gray, green-yellow

[www.wago.com/2020-212/000-036](http://www.wago.com/2020-212/000-036)



**Item no.: 2020-212/000-037**

2-conductor female connector; 1.5 mm<sup>2</sup>; 12-pole; 1,50 mm<sup>2</sup>; green-yellow, gray

[www.wago.com/2020-212/000-037](http://www.wago.com/2020-212/000-037)



**Item no.: 2020-212/000-038**

2-conductor female connector; 1.5 mm<sup>2</sup>; 12-pole; 1,50 mm<sup>2</sup>; gray, blue, green-yellow

[www.wago.com/2020-212/000-038](http://www.wago.com/2020-212/000-038)



**Item no.: 2020-212/000-039**

2-conductor female connector; 1.5 mm<sup>2</sup>; 12-pole; 1,50 mm<sup>2</sup>; green-yellow, blue, gray

[www.wago.com/2020-212/000-039](http://www.wago.com/2020-212/000-039)



**Item no.: 2020-213**

2-conductor female connector; 1.5 mm<sup>2</sup>; 13-pole; 1,50 mm<sup>2</sup>; gray

[www.wago.com/2020-213](http://www.wago.com/2020-213)



**Item no.: 2020-213/000-036**

2-conductor female connector; 1.5 mm<sup>2</sup>; 13-pole; 1,50 mm<sup>2</sup>; gray, green-yellow

[www.wago.com/2020-213/000-036](http://www.wago.com/2020-213/000-036)



**Item no.: 2020-213/000-037**

2-conductor female connector; 1.5 mm<sup>2</sup>; 13-pole; 1,50 mm<sup>2</sup>; green-yellow, gray

[www.wago.com/2020-213/000-037](http://www.wago.com/2020-213/000-037)



**Item no.: 2020-213/000-038**

2-conductor female connector; 1.5 mm<sup>2</sup>; 13-pole; 1,50 mm<sup>2</sup>; gray, blue, green-yellow

[www.wago.com/2020-213/000-038](http://www.wago.com/2020-213/000-038)



**Item no.: 2020-213/000-039**

2-conductor female connector; 1.5 mm<sup>2</sup>; 13-pole; 1,50 mm<sup>2</sup>; green-yellow, blue, gray

[www.wago.com/2020-213/000-039](http://www.wago.com/2020-213/000-039)



**Item no.: 2020-214**

2-conductor female connector; 1.5 mm<sup>2</sup>; 14-pole; 1,50 mm<sup>2</sup>; gray

[www.wago.com/2020-214](http://www.wago.com/2020-214)



**Item no.: 2020-214/000-036**

2-conductor female connector; 1.5 mm<sup>2</sup>; 14-pole; 1,50 mm<sup>2</sup>; gray, green-yellow

[www.wago.com/2020-214/000-036](http://www.wago.com/2020-214/000-036)



**Item no.: 2020-214/000-037**

2-conductor female connector; 1.5 mm<sup>2</sup>; 14-pole; 1,50 mm<sup>2</sup>; green-yellow, gray

[www.wago.com/2020-214/000-037](http://www.wago.com/2020-214/000-037)



**Item no.: 2020-214/000-038**

2-conductor female connector; 1.5 mm<sup>2</sup>; 14-pole; 1,50 mm<sup>2</sup>; gray, blue, green-yellow

[www.wago.com/2020-214/000-038](http://www.wago.com/2020-214/000-038)



**Item no.: 2020-214/000-039**

2-conductor female connector; 1.5 mm<sup>2</sup>; 14-pole; 1,50 mm<sup>2</sup>; green-yellow, blue, gray

[www.wago.com/2020-214/000-039](http://www.wago.com/2020-214/000-039)

Subject to changes. Please also observe the further product documentation!

WAGO Kontakttechnik GmbH & Co. KG

Hansastr. 27

32423 Minden















Phone: +49571 887-0 | Fax: +49571 887-169

Email: [info.de@wago.com](mailto:info.de@wago.com) | Web: [www.wago.com](http://www.wago.com)





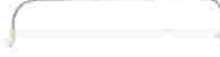











Do you have any questions about our products?

We are always happy to take your call at +49 (571) 887-44222.



	<b>Item no.: 2020-215</b> 2-conductor female connector; 1.5 mm <sup>2</sup> ; 15-pole; 1,50 mm <sup>2</sup> ; gray	<a href="http://www.wago.com/2020-215">www.wago.com/2020-215</a>
	<b>Item no.: 2020-215/000-036</b> 2-conductor female connector; 1.5 mm <sup>2</sup> ; 15-pole; 1,50 mm <sup>2</sup> ; gray, green-yellow	<a href="http://www.wago.com/2020-215/000-036">www.wago.com/2020-215/000-036</a>
	<b>Item no.: 2020-215/000-037</b> 2-conductor female connector; 1.5 mm <sup>2</sup> ; 15-pole; 1,50 mm <sup>2</sup> ; green-yellow, gray	<a href="http://www.wago.com/2020-215/000-037">www.wago.com/2020-215/000-037</a>
	<b>Item no.: 2020-215/000-038</b> 2-conductor female connector; 1.5 mm <sup>2</sup> ; 15-pole; 1,50 mm <sup>2</sup> ; gray, blue, green-yellow	<a href="http://www.wago.com/2020-215/000-038">www.wago.com/2020-215/000-038</a>
	<b>Item no.: 2020-215/000-039</b> 2-conductor female connector; 1.5 mm <sup>2</sup> ; 15-pole; 1,50 mm <sup>2</sup> ; green-yellow, blue, gray	<a href="http://www.wago.com/2020-215/000-039">www.wago.com/2020-215/000-039</a>
	<b>Item no.: 2020-261</b> Start module for 2-conductor female connector; with integrated end plate; 1.5 mm <sup>2</sup> ; 1-pole; 1,50 mm <sup>2</sup> ; gray	<a href="http://www.wago.com/2020-261">www.wago.com/2020-261</a>
	<b>Item no.: 2020-264</b> Start module for 2-conductor female connector; with integrated end plate; 1.5 mm <sup>2</sup> ; 1-pole; 1,50 mm <sup>2</sup> ; blue	<a href="http://www.wago.com/2020-264">www.wago.com/2020-264</a>
	<b>Item no.: 2020-267</b> Start module for 2-conductor female connector; 1.5 mm <sup>2</sup> ; 1-pole; 1,50 mm <sup>2</sup> ; green-yellow	<a href="http://www.wago.com/2020-267">www.wago.com/2020-267</a>
	<b>Item no.: 2020-281</b> End module for 2-conductor female connector; 1.5 mm <sup>2</sup> ; 1-pole; 1,50 mm <sup>2</sup> ; gray	<a href="http://www.wago.com/2020-281">www.wago.com/2020-281</a>
	<b>Item no.: 2020-284</b> End module for 2-conductor female connector; 1.5 mm <sup>2</sup> ; 1-pole; 1,50 mm <sup>2</sup> ; blue	<a href="http://www.wago.com/2020-284">www.wago.com/2020-284</a>
	<b>Item no.: 2020-287</b> End module for 2-conductor female connector; 1.5 mm <sup>2</sup> ; 1-pole; 1,50 mm <sup>2</sup> ; green-yellow	<a href="http://www.wago.com/2020-287">www.wago.com/2020-287</a>
<b>Push-In type wire jumper</b>		
	<b>Item no.: 2009-402</b> Push-in type wire jumper; 0.75 mm <sup>2</sup> ; insulated; 60 mm long; gray	<a href="http://www.wago.com/2009-402">www.wago.com/2009-402</a>
	<b>Item no.: 2009-404</b> Push-in type wire jumper; 0.75 mm <sup>2</sup> ; insulated; 110 mm long; gray	<a href="http://www.wago.com/2009-404">www.wago.com/2009-404</a>
	<b>Item no.: 2009-406</b> Push-in type wire jumper; 0.75 mm <sup>2</sup> ; insulated; 250 mm long; gray	<a href="http://www.wago.com/2009-406">www.wago.com/2009-406</a>
<b>Protective Warning Marker</b>		
	<b>Item no.: 2000-115</b> Protective warning marker; with high-voltage symbol, black; for 5 terminal blocks; yellow	<a href="http://www.wago.com/2000-115">www.wago.com/2000-115</a>
<b>check</b>		

Subject to changes. Please also observe the further product documentation!

	<b>Item no.: 2000-510</b> TOPJOB®S L-type test plug module; modular; for jumper contact slot; 1,00 mm <sup>2</sup> ; gray	<a href="http://www.wago.com/2000-510">www.wago.com/2000-510</a>
	<b>Item no.: 2000-552</b> Modular TOPJOB®S connector; modular; for jumper contact slot; 2-pole; 1,00 mm <sup>2</sup> ; gray	<a href="http://www.wago.com/2000-552">www.wago.com/2000-552</a>
	<b>Item no.: 2000-553</b> Modular TOPJOB®S connector; modular; for jumper contact slot; 3-pole; 1,00 mm <sup>2</sup> ; gray	<a href="http://www.wago.com/2000-553">www.wago.com/2000-553</a>
	<b>Item no.: 2000-554</b> Modular TOPJOB®S connector; modular; for jumper contact slot; 4-pole; 1,00 mm <sup>2</sup> ; gray	<a href="http://www.wago.com/2000-554">www.wago.com/2000-554</a>
	<b>Item no.: 2000-555</b> Modular TOPJOB®S connector; modular; for jumper contact slot; 5-pole; 1,00 mm <sup>2</sup> ; gray	<a href="http://www.wago.com/2000-555">www.wago.com/2000-555</a>
	<b>Item no.: 2000-556</b> Modular TOPJOB®S connector; modular; for jumper contact slot; 6-pole; 1,00 mm <sup>2</sup> ; gray	<a href="http://www.wago.com/2000-556">www.wago.com/2000-556</a>
	<b>Item no.: 2000-557</b> Modular TOPJOB®S connector; modular; for jumper contact slot; 7-pole; 1,00 mm <sup>2</sup> ; gray	<a href="http://www.wago.com/2000-557">www.wago.com/2000-557</a>
	<b>Item no.: 2000-558</b> Modular TOPJOB®S connector; modular; for jumper contact slot; 8-pole; 1,00 mm <sup>2</sup> ; gray	<a href="http://www.wago.com/2000-558">www.wago.com/2000-558</a>
	<b>Item no.: 2000-559</b> Modular TOPJOB®S connector; modular; for jumper contact slot; 9-pole; 1,00 mm <sup>2</sup> ; gray	<a href="http://www.wago.com/2000-559">www.wago.com/2000-559</a>
	<b>Item no.: 2000-560</b> Modular TOPJOB®S connector; modular; for jumper contact slot; 10-pole; 1,00 mm <sup>2</sup> ; gray	<a href="http://www.wago.com/2000-560">www.wago.com/2000-560</a>
	<b>Item no.: 2009-174</b> Test plug adapter; for 4 mm Ø test plugs; for testing TOPJOB®S rail-mounted terminal blocks; gray	<a href="http://www.wago.com/2009-174">www.wago.com/2009-174</a>
	<b>Item no.: 2009-182</b> Testing tap; for max. 2.5 mm <sup>2</sup> ; tool-free connection for individual test wires 0.08 - 2.5 mm; gray	<a href="http://www.wago.com/2009-182">www.wago.com/2009-182</a>
<b>tools</b>		
	<b>Item no.: 210-647</b> Operating tool; Blade: 2.5 x 0.4 mm; with a partially insulated shaft; multicoloured	<a href="http://www.wago.com/210-647">www.wago.com/210-647</a>
	<b>Item no.: 210-648</b> Operating tool; Blade: 2.5 x 0.4 mm; with a partially insulated shaft; angled; short	<a href="http://www.wago.com/210-648">www.wago.com/210-648</a>
	<b>Item no.: 210-719</b> Operating tool; Blade: 2.5 x 0.4 mm; with a partially insulated shaft	<a href="http://www.wago.com/210-719">www.wago.com/210-719</a>
<b>Jumper</b>		
	<b>Item no.: 2000-402</b> Jumper; 2-way; insulated; light gray	<a href="http://www.wago.com/2000-402">www.wago.com/2000-402</a>
	<b>Item no.: 2000-402/000-005</b> Jumper; 2-way; insulated; red	<a href="http://www.wago.com/2000-402/000-005">www.wago.com/2000-402/000-005</a>

Subject to changes. Please also observe the further product documentation!



**Item no.: 2000-402/000-006**  
Jumper; 2-way; insulated; blue

[www.wago.com/2000-402/000-006](http://www.wago.com/2000-402/000-006)



**Item no.: 2000-402/000-018**  
Jumper; 2-way; insulated; yellow-green

[www.wago.com/2000-402/000-018](http://www.wago.com/2000-402/000-018)



**Item no.: 2000-403**  
Jumper; 3-way; insulated; light gray

[www.wago.com/2000-403](http://www.wago.com/2000-403)



**Item no.: 2000-403/000-005**  
Jumper; 3-way; insulated; red

[www.wago.com/2000-403/000-005](http://www.wago.com/2000-403/000-005)



**Item no.: 2000-403/000-006**  
Jumper; 3-way; insulated; blue

[www.wago.com/2000-403/000-006](http://www.wago.com/2000-403/000-006)



**Item no.: 2000-404**  
Jumper; 4-way; insulated; light gray

[www.wago.com/2000-404](http://www.wago.com/2000-404)



**Item no.: 2000-404/000-005**  
Jumper; 4-way; insulated; red

[www.wago.com/2000-404/000-005](http://www.wago.com/2000-404/000-005)



**Item no.: 2000-404/000-006**  
Jumper; 4-way; insulated; blue

[www.wago.com/2000-404/000-006](http://www.wago.com/2000-404/000-006)



**Item no.: 2000-405**  
Jumper; 5-way; insulated; light gray

[www.wago.com/2000-405](http://www.wago.com/2000-405)



**Item no.: 2000-405/000-005**  
Jumper; 5-way; insulated; red

[www.wago.com/2000-405/000-005](http://www.wago.com/2000-405/000-005)



**Item no.: 2000-405/000-006**  
Jumper; 5-way; insulated; blue

[www.wago.com/2000-405/000-006](http://www.wago.com/2000-405/000-006)



**Item no.: 2000-405/011-000**  
Star point jumper; 3-way; insulated; light gray

[www.wago.com/2000-405/011-000](http://www.wago.com/2000-405/011-000)



**Item no.: 2000-406**  
Jumper; 6-way; insulated; light gray

[www.wago.com/2000-406](http://www.wago.com/2000-406)



**Item no.: 2000-406/000-005**  
Jumper; 6-way; insulated; red

[www.wago.com/2000-406/000-005](http://www.wago.com/2000-406/000-005)

Subject to changes. Please also observe the further product documentation!



**Item no.: 2000-406/000-006**  
Jumper; 6-way; insulated; blue

[www.wago.com/2000-406/000-006](http://www.wago.com/2000-406/000-006)



**Item no.: 2000-406/020-000**  
Delta jumper; insulated; light gray

[www.wago.com/2000-406/020-000](http://www.wago.com/2000-406/020-000)



**Item no.: 2000-407**  
Jumper; 7-way; insulated; light gray

[www.wago.com/2000-407](http://www.wago.com/2000-407)



**Item no.: 2000-407/000-005**  
Jumper; 7-way; insulated; red

[www.wago.com/2000-407/000-005](http://www.wago.com/2000-407/000-005)



**Item no.: 2000-407/000-006**  
Jumper; 7-way; insulated; blue

[www.wago.com/2000-407/000-006](http://www.wago.com/2000-407/000-006)



**Item no.: 2000-408**  
Jumper; 8-way; insulated; light gray

[www.wago.com/2000-408](http://www.wago.com/2000-408)



**Item no.: 2000-408/000-005**  
Jumper; 8-way; insulated; red

[www.wago.com/2000-408/000-005](http://www.wago.com/2000-408/000-005)



**Item no.: 2000-408/000-006**  
Jumper; 8-way; insulated; blue

[www.wago.com/2000-408/000-006](http://www.wago.com/2000-408/000-006)



**Item no.: 2000-409**  
Jumper; 9-way; insulated; light gray

[www.wago.com/2000-409](http://www.wago.com/2000-409)



**Item no.: 2000-409/000-005**  
Jumper; 9-way; insulated; red

[www.wago.com/2000-409/000-005](http://www.wago.com/2000-409/000-005)



**Item no.: 2000-409/000-006**  
Jumper; 9-way; insulated; blue

[www.wago.com/2000-409/000-006](http://www.wago.com/2000-409/000-006)



**Item no.: 2000-410**  
Jumper; 10-way; insulated; light gray

[www.wago.com/2000-410](http://www.wago.com/2000-410)



**Item no.: 2000-410/000-005**  
Jumper; 10-way; insulated; red















[www.wago.com/2000-410/000-005](http://www.wago.com/2000-410/000-005)





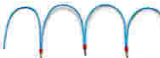











**Item no.: 2000-410/000-006**  
Jumper; 10-way; insulated; blue

[www.wago.com/2000-410/000-006](http://www.wago.com/2000-410/000-006)

Subject to changes. Please also observe the further product documentation!

	<b>Item no.: 2000-433</b> Jumper; from 1 to 3; insulated; light gray	<a href="http://www.wago.com/2000-433">www.wago.com/2000-433</a>
	<b>Item no.: 2000-433/000-005</b> Jumper; from 1 to 3; insulated; red	<a href="http://www.wago.com/2000-433/000-005">www.wago.com/2000-433/000-005</a>
	<b>Item no.: 2000-433/000-006</b> Jumper; from 1 to 3; insulated; blue	<a href="http://www.wago.com/2000-433/000-006">www.wago.com/2000-433/000-006</a>
	<b>Item no.: 2000-434</b> Jumper; from 1 to 4; insulated; light gray	<a href="http://www.wago.com/2000-434">www.wago.com/2000-434</a>
	<b>Item no.: 2000-435</b> Jumper; from 1 to 5; insulated; light gray	<a href="http://www.wago.com/2000-435">www.wago.com/2000-435</a>
	<b>Item no.: 2000-436</b> Jumper; from 1 to 6; insulated; light gray	<a href="http://www.wago.com/2000-436">www.wago.com/2000-436</a>
	<b>Item no.: 2000-437</b> Jumper; from 1 to 7; insulated; light gray	<a href="http://www.wago.com/2000-437">www.wago.com/2000-437</a>
	<b>Item no.: 2000-438</b> Jumper; from 1 to 8; insulated; light gray	<a href="http://www.wago.com/2000-438">www.wago.com/2000-438</a>
	<b>Item no.: 2000-439</b> Jumper; from 1 to 9; insulated; light gray	<a href="http://www.wago.com/2000-439">www.wago.com/2000-439</a>
	<b>Item no.: 2000-440</b> Jumper; from 1 to 10; insulated; light gray	<a href="http://www.wago.com/2000-440">www.wago.com/2000-440</a>
	<b>Item no.: 210-103</b> Wire commoning chain; insulated; black	<a href="http://www.wago.com/210-103">www.wago.com/210-103</a>
	<b>Item no.: 210-123</b> Wire commoning chain; insulated; blue	<a href="http://www.wago.com/210-123">www.wago.com/210-123</a>
<b>ferrule</b>		
	<b>Item no.: 216-241</b> Ferrule; Sleeve for 0.5 mm <sup>2</sup> / 20 AWG; insulated; electro-tin plated; electrolytic copper; gastight crimped; acc. to DIN 46228, Part 4/09.90; white	<a href="http://www.wago.com/216-241">www.wago.com/216-241</a>
	<b>Item no.: 216-242</b> Ferrule; Sleeve for 0.75 mm <sup>2</sup> / 18 AWG; insulated; electro-tin plated; electrolytic copper; gastight crimped; acc. to DIN 46228, Part 4/09.90; gray	<a href="http://www.wago.com/216-242">www.wago.com/216-242</a>
	<b>Item no.: 216-243</b> Ferrule; Sleeve for 1 mm <sup>2</sup> / AWG 18; insulated; electro-tin plated; electrolytic copper; gastight crimped; acc. to DIN 46228, Part 4/09.90; red	<a href="http://www.wago.com/216-243">www.wago.com/216-243</a>
<b>Marking accessories</b>		
	<b>Item no.: 2000-121</b> Adaptor; gray	<a href="http://www.wago.com/2000-121">www.wago.com/2000-121</a>

Subject to changes. Please also observe the further product documentation!

	<b>Item no.: 2009-110</b> Marking strips; for Smart Printer; on reel; not stretchable; plain; snap-on type; white	<a href="http://www.wago.com/2009-110">www.wago.com/2009-110</a>
	<b>Item no.: 2009-113</b> WMB-Inline; for Smart Printer; 2300 pieces on roll; plain; snap-on type; white	<a href="http://www.wago.com/2009-113">www.wago.com/2009-113</a>
	<b>Item no.: 2009-113/000-002</b> WMB-Inline; for Smart Printer; 2300 pieces on roll; plain; snap-on type; yellow	<a href="http://www.wago.com/2009-113/000-002">www.wago.com/2009-113/000-002</a>
	<b>Item no.: 2009-113/000-005</b> WMB-Inline; for Smart Printer; 2300 pieces on roll; plain; snap-on type; red	<a href="http://www.wago.com/2009-113/000-005">www.wago.com/2009-113/000-005</a>
	<b>Item no.: 2009-113/000-006</b> WMB-Inline; for Smart Printer; 2300 pieces on roll; plain; snap-on type; blue	<a href="http://www.wago.com/2009-113/000-006">www.wago.com/2009-113/000-006</a>
	<b>Item no.: 2009-113/000-007</b> WMB-Inline; for Smart Printer; 2300 pieces on roll; plain; snap-on type; gray	<a href="http://www.wago.com/2009-113/000-007">www.wago.com/2009-113/000-007</a>
	<b>Item no.: 2009-113/000-012</b> WMB-Inline; for Smart Printer; 2300 pieces on roll; plain; snap-on type; orange	<a href="http://www.wago.com/2009-113/000-012">www.wago.com/2009-113/000-012</a>
	<b>Item no.: 2009-113/000-017</b> WMB-Inline; for Smart Printer; 2300 pieces on roll; plain; snap-on type; light green	<a href="http://www.wago.com/2009-113/000-017">www.wago.com/2009-113/000-017</a>
	<b>Item no.: 2009-113/000-023</b> WMB-Inline; for Smart Printer; 2300 pieces on roll; plain; snap-on type; green	<a href="http://www.wago.com/2009-113/000-023">www.wago.com/2009-113/000-023</a>
	<b>Item no.: 2009-113/000-024</b> WMB-Inline; for Smart Printer; 2300 pieces on roll; plain; snap-on type; violet	<a href="http://www.wago.com/2009-113/000-024">www.wago.com/2009-113/000-024</a>
	<b>Item no.: 2009-191</b> Group marker carrier	<a href="http://www.wago.com/2009-191">www.wago.com/2009-191</a>
	<b>Item no.: 793-3501</b> WMB marking card; as card; plain; snap-on type; white	<a href="http://www.wago.com/793-3501">www.wago.com/793-3501</a>
<b>Carrier rail</b>		
	<b>Item no.: 210-112</b> Steel carrier rail; 35 x 7.5 mm; 1 mm thick; 2 m long; slotted; according to EN 60715; "Hole width 25 mm; silver-colored	<a href="http://www.wago.com/210-112">www.wago.com/210-112</a>
	<b>Item no.: 210-113</b> Steel carrier rail; 35 x 7.5 mm; 1 mm thick; 2 m long; unslotted; according to EN 60715; silver-colored	<a href="http://www.wago.com/210-113">www.wago.com/210-113</a>
	<b>Item no.: 210-114</b> Steel carrier rail; 35 x 15 mm; 1.5 mm thick; 2 m long; unslotted; similar to EN 60715; silver-colored	<a href="http://www.wago.com/210-114">www.wago.com/210-114</a>

Subject to changes. Please also observe the further product documentation!



**Item no.: 210-115**

Steel carrier rail; 35 x 7.5 mm; 1 mm thick; 2 m long; slotted; according to EN 60715; "Hole width 18 mm; [www.wago.com/210-115](http://www.wago.com/210-115) silver-colored



**Item no.: 210-118**

Steel carrier rail; 35 x 15 mm; 2.3 mm thick; 2 m long; unslotted; according to EN 60715; silver-colored [www.wago.com/210-118](http://www.wago.com/210-118)



**Item no.: 210-196**

Aluminum carrier rail; 35 x 8.2 mm; 1.6 mm thick; 2 m long; unslotted; similar to EN 60715; silver-colored [www.wago.com/210-196](http://www.wago.com/210-196)



**Item no.: 210-197**

Steel carrier rail; 35 x 15 mm; 1.5 mm thick; 2 m long; slotted; similar to EN 60715; silver-colored [www.wago.com/210-197](http://www.wago.com/210-197)



**Item no.: 210-198**

Copper carrier rail; 35 x 15 mm; 2.3 mm thick; 2 m long; unslotted; according to EN 60715; copper-colored [www.wago.com/210-198](http://www.wago.com/210-198)

**Coding**



**Item no.: 2020-100**

Carrier with 6 coding pins; for coding of female plugs; for carrier terminal blocks; orange [www.wago.com/2020-100](http://www.wago.com/2020-100)

**Downloads**

**Documentation**

**Bid Text**

2020-5317/1102-950 docx - Datei	7. 8. 2018	docx 15.5 kB	Download
------------------------------------	------------	-----------------	----------

2020-5317/1102-950 X81 - Datei	19. 2. 2019	xml 4.3 kB	Download
-----------------------------------	-------------	---------------	----------

**Additional Information**

Technical explanations	3. 4. 2019	pdf 2.2 MB	Download
------------------------	------------	---------------	----------

**CAD/CAE-Data**

**CAD data**

2D/3D Models 2020-5317/1102-950		URL	Download
---------------------------------	--	-----	----------

**CAE data**

ZUKEN Portal 2020-5317/1102-950		URL	Download
---------------------------------	--	-----	----------

Subject to changes. Please also observe the further product documentation!

## Environmental Product Compliance

### Compliance Search

Environmental Product Compliance 2020-5317/1102-950

URL

Download

3-conductor actuator supply terminal block; LED (yellow); for PNP-(high-side) switching actuators; with ground contact; with pluggable signal level; 1 mm<sup>2</sup>; Push-in CAGE CLAMP®; 1,00 mm<sup>2</sup>; gray

## Installation Notes

### Installation

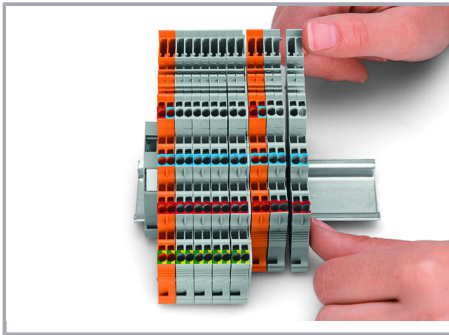

Snap individual terminal blocks onto the DIN-rail and slide together.

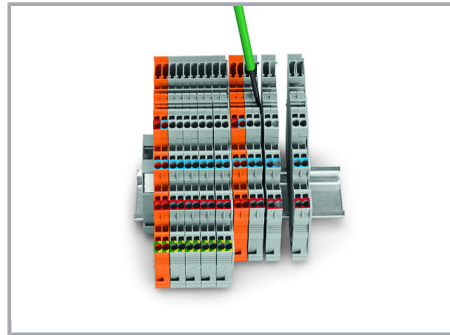

Separate terminal block assembly and slide individual terminal blocks laterally using an operating tool.

### Testing

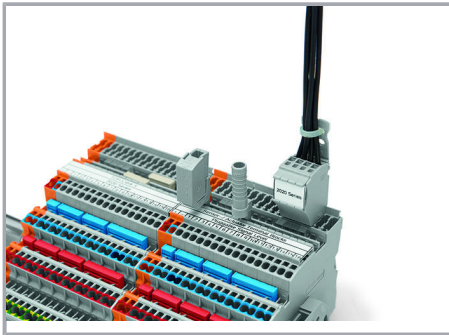

Testing via testing tap (2009-182) or test plug adapter (2009-174) (up to max. 42 V).

### Coding

Subject to changes. Please also observe the further product documentation!



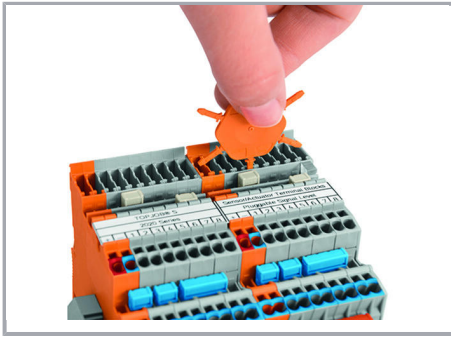

Insert coding pin into the corresponding slot and twist it off.

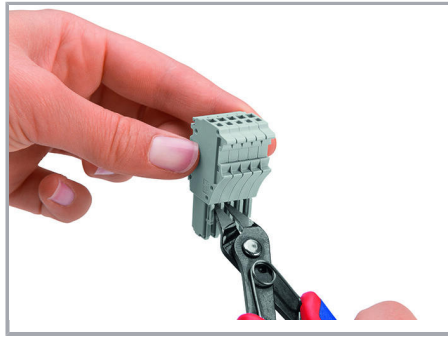

Remove the coding finger using a cutting tool.

### Locking system

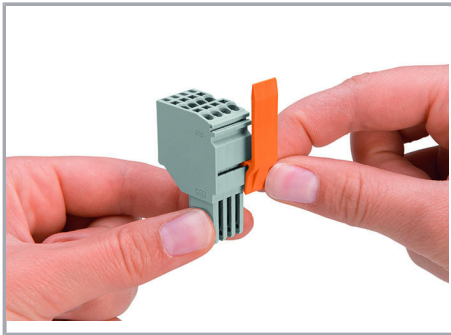

Slide the locking lever into position.

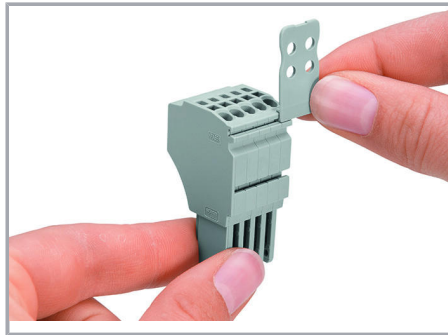

### Strain relief

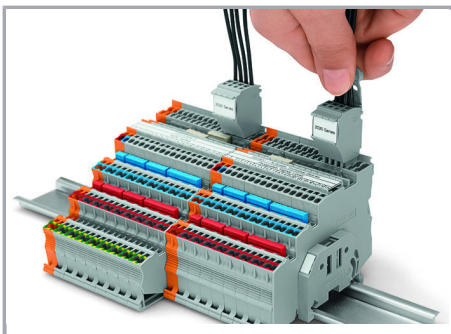

Removing a female plug via conductor bundle provided with strain relief plate.

### Marking

Subject to changes. Please also observe the further product documentation!

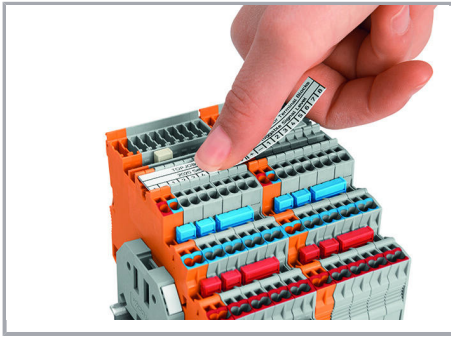

Labeling terminal blocks via marking strips (2009-110) or 3.5 mm wide WMB markers (793-35xx) – from the top or the side.

## Product family

### TOPJOB® S

TOPJOB® S: In various industrial applications and modern building installations, WAGO's wide and versatile range of rail-mount terminal blocks provides more than just reliable electrical connections.

[Show all products from the family](#)

Subject to changes. Please also observe the further product documentation!