

PC 6/ 3-ST-7,62 - PCB connector



1149083

<https://www.phoenixcontact.com/sk/products/1149083>

Please be informed that the data shown in this PDF document is generated from our online catalog. Please find the complete data in the user documentation. Our general terms of use for downloads are valid.

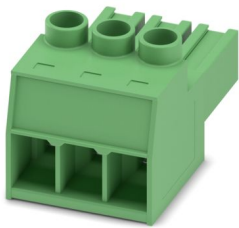

PCB connector, nominal cross section: 6 mm², color: green, nominal current: 41 A, rated voltage (III/2): 1000 V, contact surface: Sn, contact connection type: Socket, number of rows: 1, number of positions: 3, product range: PC 6/..-ST, pitch: 7.62 mm, connection method: Screw connection with tension sleeve, screw head form: Z1L Slotted Pozidriv, conductor/PCB connection direction: 0 °, locking clip: - without locking clip, plug-in system: COMBICON PC 6, locking: without, mounting: without, type of packaging: packed in cardboard

Your advantages

- Well-known connection principle allows worldwide use
- Low temperature rise, thanks to maximum contact force
- Allows connection of two conductors
- Increased touch protection in accordance with IEC/UL 61800-5-1

Commercial data

Item number	1149083
Packing unit	50 pc
Minimum order quantity	50 pc
Note	Made to order (non-returnable)
Sales key	AAD
Product key	AADAFA
GTIN	4063151142735
Weight per piece (including packing)	17 g
Weight per piece (excluding packing)	17 g
Customs tariff number	85366990
Country of origin	CN

PC 6/ 3-ST-7,62 - PCB connector



1149083

<https://www.phoenixcontact.com/sk/products/1149083>

Technical data

Product properties

Product type	PCB connector
Product family	PC 6/..-ST
Product line	COMBICON Connectors L
Number of positions	3
Pitch	7.62 mm
Number of rows	1

Data management status

Article revision	02
------------------	----

Electrical properties

Nominal current I_N	41 A
Nominal voltage U_N	1000 V
Contact resistance	0.4 m Ω
Rated voltage (III/3)	1000 V
Rated surge voltage (III/3)	8 kV
Rated voltage (III/2)	1000 V
Rated surge voltage (III/2)	8 kV
Rated voltage (II/2)	1000 V
Rated surge voltage (II/2)	6 kV

Connection data

Connection technology

Connector system	COMBICON PC 6
Nominal cross section	6 mm ²
Contact connection type	Socket

Interlock

Locking type	without
Mounting flange	without

Conductor connection

Connection method	Screw connection with tension sleeve
Conductor/PCB connection direction	0 °
Conductor cross section rigid	0.2 mm ² ... 10 mm ²
Conductor cross section flexible	0.2 mm ² ... 6 mm ²
Conductor cross section AWG	24 ... 8
Conductor cross section flexible, with ferrule without plastic sleeve	0.25 mm ² ... 6 mm ²
Conductor cross section, flexible, with ferrule, with plastic sleeve	0.25 mm ² ... 4 mm ²
2 conductors with same cross section, solid	0.2 mm ² ... 2.5 mm ²
2 conductors with same cross section, flexible	0.2 mm ² ... 4 mm ²

PC 6/ 3-ST-7,62 - PCB connector

1149083

<https://www.phoenixcontact.com/sk/products/1149083>

2 conductors with same cross section, flexible, with ferrule without plastic sleeve	0.25 mm ² ... 1.5 mm ²
2 conductors with the same cross section, flexible, with TWIN ferrule with plastic sleeve	0.25 mm ² ... 2.5 mm ²
Stripping length	12 mm
Drive form screw head	Slotted Pozidriv (Z1L)
Tightening torque	0.5 Nm ... 0.8 Nm ($\leq 4 \text{ mm}^2$ is 0.5 Nm to 0.6 Nm, $> 4 \text{ mm}^2$ is 0.7 Nm to 0.8 Nm)

Material specifications

Material data - contact

Note	WEEE/RoHS-compliant, free of whiskers according to IEC 60068-2-82/JEDEC JESD 201
Contact material	Cu alloy
Surface characteristics	hot-dip tin-plated
Metal surface terminal point (top layer)	Tin (4 - 8 μm Sn)
Metal surface contact area (top layer)	Tin (4 - 8 μm Sn)

Material data - housing

Color (Housing)	green (6021)
Insulating material	PA
Insulating material group	I
CTI according to IEC 60112	600
Flammability rating according to UL 94	V0
Glow wire flammability index GWFI according to EN 60695-2-12	850
Glow wire ignition temperature GWIT according to EN 60695-2-13	775
Temperature for the ball pressure test according to EN 60695-10-2	125 °C

Dimensions

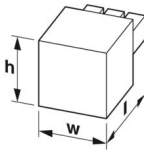
Dimensional drawing	
Pitch	7.62 mm
Width [w]	23.76 mm
Height [h]	24.4 mm
Length [l]	40 mm

Notes

Notes on operation	In accordance with IEC 61984, COMBICON connectors have no switching power (COC). During designated use, they must not be plugged in or disconnected when carrying voltage or under load.
--------------------	--

Mechanical tests

Test for conductor damage and slackening

Specification	IEC 60999-1:1999-11
Result	Test passed

Pull-out test

Specification	IEC 60999-1:1999-11
Conductor cross section/conductor type/tractive force setpoint/actual value	0.2 mm ² / solid / > 10 N
	0.2 mm ² / flexible / > 10 N
	10 mm ² / solid / > 90 N
	6 mm ² / flexible / > 80 N

Insertion and withdrawal forces

Specification	IEC 60512-13-2:2006-02
Result	Test passed
No. of cycles	25
Insertion strength per pos. approx.	8 N
Withdraw strength per pos. approx.	5 N

Torque test

Specification	IEC 60999-1:1999-11
---------------	---------------------

Resistance of inscriptions

Specification	IEC 60068-2-70:1995-12
Result	Test passed

Polarization and coding

Specification	IEC 60512-13-5:2006-02
Result	Test passed

Visual inspection

Specification	IEC 60512-1-1:2002-02
Result	Test passed

Dimension check

Specification	IEC 60512-1-2:2002-02
Result	Test passed

Environmental and real-life conditions

Vibration test

Specification	IEC 60068-2-6:2007-12
Frequency	10 - 150 - 10 Hz
Sweep speed	1 octave/min
Amplitude	0.35 mm (10 Hz ... 60.1 Hz)
Acceleration	5g (60.1 Hz ... 150 Hz)

PC 6/ 3-ST-7,62 - PCB connector



1149083

<https://www.phoenixcontact.com/sk/products/1149083>

Test duration per axis	2.5 h
Test directions	X-, Y- and Z-axis

Durability test

Specification	IEC 60512-9-1:2010-03
Impulse withstand voltage at sea level	9.8 kV
Contact resistance R ₁	0.4 mΩ
Contact resistance R ₂	0.4 mΩ
Insertion/withdrawal cycles	25
Insulation resistance, neighboring positions	> 5 MΩ

Climatic test

Specification	ISO 22479:2019-05
Corrosive stress	0.2 dm ³ SO ₂ on 300 dm ³ /40 °C/1 cycle
Thermal stress	100 °C/168 h
Power-frequency withstand voltage	4.26 kV

Ambient conditions

Ambient temperature (operation)	-40 °C ... 100 °C (dependent on the derating curve)
Ambient temperature (storage/transport)	-40 °C ... 70 °C
Relative humidity (storage/transport)	30 % ... 70 %
Ambient temperature (assembly)	-5 °C ... 100 °C

Electrical tests

Thermal test | Test group C

Specification	IEC 60512-5-1:2002-02
Tested number of positions	6

Insulation resistance

Specification	IEC 60512-3-1:2002-02
Insulation resistance, neighboring positions	> 5 MΩ

Air clearances and creepage distances | 1. Insulation coordination

Specification	IEC 61984:2008-10
Insulating material group	I
Comparative tracking index (IEC 60112)	CTI 600
Rated insulation voltage (III/3)	1000 V
Rated surge voltage (III/3)	8 kV
minimum clearance value - non-homogenous field (III/3)	8 mm
minimum creepage distance (III/3)	12.5 mm
Rated insulation voltage (III/2)	1000 V
Rated surge voltage (III/2)	8 kV
minimum clearance value - non-homogenous field (III/2)	8 mm
minimum creepage distance (III/2)	8 mm
Rated insulation voltage (II/2)	1000 V
Rated surge voltage (II/2)	6 kV

PC 6/ 3-ST-7,62 - PCB connector



1149083

<https://www.phoenixcontact.com/sk/products/1149083>

minimum clearance value - non-homogenous field (l1/2)	5.5 mm
minimum creepage distance (l1/2)	5.5 mm

Packaging specifications

Type of packaging	packed in cardboard
-------------------	---------------------

PC 6/ 3-ST-7,62 - PCB connector



1149083

<https://www.phoenixcontact.com/sk/products/1149083>

Drawings

Diagram

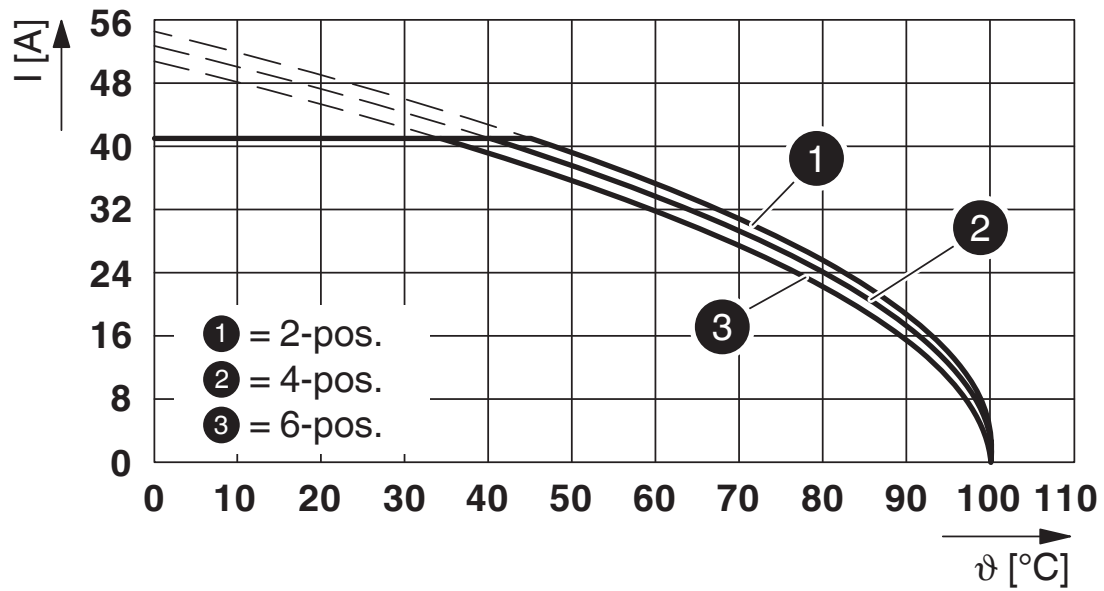

Type: PC 6/...-ST-7,62 with PC 6/...-G-7,62

PC 6/ 3-ST-7,62 - PCB connector



1149083

<https://www.phoenixcontact.com/sk/products/1149083>

Classifications

ECLASS

ECLASS-11.0	27460202
ECLASS-12.0	27460202
ECLASS-13.0	27460202

ETIM

ETIM 9.0	EC002638
----------	----------

UNSPSC

UNSPSC 21.0	39121409
-------------	----------

PC 6/ 3-ST-7,62 - PCB connector



1149083

<https://www.phoenixcontact.com/sk/products/1149083>

Environmental product compliance

EU RoHS

Fulfills EU RoHS substance requirements	Yes, No exemptions
---	--------------------

China RoHS

Environment friendly use period (EFUP)	EFUP-E
	No hazardous substances above the limits

EU REACH SVHC

REACH candidate substance (CAS No.)	No substance above 0.1 wt%
-------------------------------------	----------------------------

PC 6/ 3-ST-7,62 - PCB connector

1149083

<https://www.phoenixcontact.com/sk/products/1149083>

Accessories

CP-PC RD - Coding profile

1701967

<https://www.phoenixcontact.com/sk/products/1701967>

Coding profile, for plugging into the coding ribs of the plug at a later date, insulating material, color: Red



WIREFOX 10 - Stripping tool

1212150

<https://www.phoenixcontact.com/sk/products/1212150>

Stripping tool, for cables and conductors from 0.02 - 10 mm², self-adjusting, stripping length of up to 18 mm, cutting capacity of up to 10 mm² stranded/1.5 mm² solid, replaceable stripping blade



PC 6/ 3-ST-7,62 - PCB connector

1149083

<https://www.phoenixcontact.com/sk/products/1149083>



CRIMPFOX CENTRUS 6S - Crimping pliers

1213144

<https://www.phoenixcontact.com/sk/products/1213144>



Crimping pliers, for uninsulated and insulated ferrules, DIN 46228 Part 1 and 4, from 0.14 mm² ... 6 mm², also for TWIN ferrules up to 2 x 4 mm², automatic cross section adjustment, lateral insertion, equipped with fall protection

AI 6 -18 YE - Ferrule

3200603

<https://www.phoenixcontact.com/sk/products/3200603>



Ferrule, Length contact range: 18 mm, sleeve length: 26 mm, color: yellow

PC 6/ 3-ST-7,62 - PCB connector

1149083

<https://www.phoenixcontact.com/sk/products/1149083>



SZK PZ1 VDE - Screwdriver

1206450

<https://www.phoenixcontact.com/sk/products/1206450>



Screwdriver, PZ crosshead, VDE insulated, size: PZ 1 x 80 mm, 2-component grip, with non-slip grip

PC 6/ 3-G-7,62 P26THR - PCB header

1190487

<https://www.phoenixcontact.com/sk/products/1190487>



PCB headers, nominal cross section: 6 mm², color: black, nominal current: 41 A, rated voltage (III/2): 630 V, contact surface: Sn, contact connection type: Pin, number of rows: 1, number of positions: 3, product range: PC 6/..-G-THR, pitch: 7.62 mm, mounting: THR soldering / wave soldering, pin layout: Linear pinning, solder pin [P]: 2.6 mm, number of solder pins per potential: 3, plug-in system: COMBICON PC 6, Pin connector pattern alignment: Standard, locking: without, mounting: without, type of packaging: packed in cardboard

PC 6/ 3-ST-7,62 - PCB connector

1149083

<https://www.phoenixcontact.com/sk/products/1149083>



PC 6/ 3-GU-7,62 P26THR - PCB header

1192635

<https://www.phoenixcontact.com/sk/products/1192635>

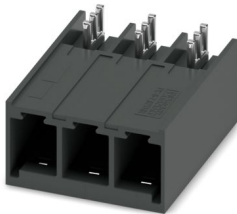

PCB headers, nominal cross section: 6 mm², color: black, nominal current: 41 A, rated voltage (III/2): 630 V, contact surface: Sn, contact connection type: Pin, number of rows: 1, number of positions: 3, product range: PC 6/..-GU-THR, pitch: 7.62 mm, mounting: THR soldering / wave soldering, pin layout: Linear pinning, solder pin [P]: 2.6 mm, number of solder pins per potential: 3, plug-in system: COMBICON PC 6, Pin connector pattern alignment: reversed, locking: without, mounting: without, type of packaging: packed in cardboard

PCV 6/ 3-G-7,62 P26THR - PCB header

1192625

<https://www.phoenixcontact.com/sk/products/1192625>

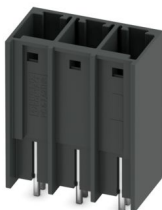

PCB headers, nominal cross section: 6 mm², color: black, nominal current: 41 A, rated voltage (III/2): 630 V, contact surface: Sn, contact connection type: Pin, number of rows: 1, number of positions: 3, product range: PCV 6/..-G-THR, pitch: 7.62 mm, mounting: THR soldering / wave soldering, pin layout: Linear pinning, solder pin [P]: 2.6 mm, number of solder pins per potential: 3, plug-in system: COMBICON PC 6, Pin connector pattern alignment: Standard, locking: without, mounting: without, type of packaging: packed in cardboard

PC 6/ 3-ST-7,62 - PCB connector

1149083

<https://www.phoenixcontact.com/sk/products/1149083>

PC 6/ 3-G-7,62 P26THRR56 - PCB header

1199930

<https://www.phoenixcontact.com/sk/products/1199930>



PCB headers, nominal cross section: 6 mm², color: black, nominal current: 41 A, rated voltage (III/2): 630 V, contact surface: Sn, contact connection type: Pin, number of rows: 1, number of positions: 3, product range: PC 6/..-G-THR, pitch: 7.62 mm, mounting: THR soldering / wave soldering, pin layout: Linear pinning, solder pin [P]: 2.6 mm, number of solder pins per potential: 3, plug-in system: COMBICON PC 6, Pin connector pattern alignment: Standard, locking: without, mounting: without, type of packaging: 44 mm wide tape

PC 6/ 3-G-7,62 - PCB header

1054547

<https://www.phoenixcontact.com/sk/products/1054547>

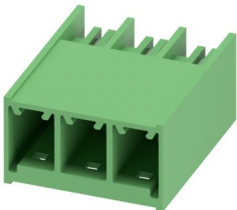

PCB headers, nominal cross section: 6 mm², color: green, nominal current: 41 A, rated voltage (III/2): 630 V, contact surface: Sn, contact connection type: Pin, number of potentials: 3, number of rows: 1, number of positions: 3, number of connections: 3, product range: PC 6/..-G, pitch: 7.62 mm, mounting: Wave soldering, pin layout: Linear pinning, solder pin [P]: 2.6 mm, number of solder pins per potential: 3, plug-in system: COMBICON PC 6, Pin connector pattern alignment: Standard, locking: without, mounting: without, type of packaging: packed in cardboard

PC 6/ 3-ST-7,62 - PCB connector

1149083

<https://www.phoenixcontact.com/sk/products/1149083>



PC 6/ 3-GU-7,62 - PCB header

1055247

<https://www.phoenixcontact.com/sk/products/1055247>

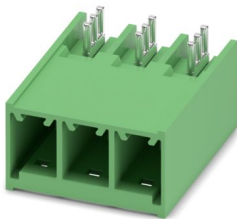

PCB headers, nominal cross section: 6 mm², color: green, nominal current: 41 A, rated voltage (III/2): 630 V, contact surface: Sn, contact connection type: Pin, number of potentials: 3, number of rows: 1, number of positions: 3, number of connections: 3, product range: PC 6/..-GU, pitch: 7.62 mm, mounting: Wave soldering, pin layout: Linear pinning, solder pin [P]: 2.6 mm, number of solder pins per potential: 3, plug-in system: COMBICON PC 6, Pin connector pattern alignment: reversed, locking: without, mounting: without, type of packaging: packed in cardboard

PCV 6/ 3-G-7,62 - PCB header

1131531

<https://www.phoenixcontact.com/sk/products/1131531>

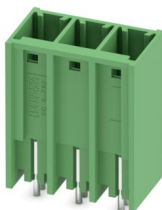

PCB headers, nominal cross section: 6 mm², color: green, nominal current: 41 A, rated voltage (III/2): 630 V, contact surface: Sn, contact connection type: Pin, number of potentials: 3, number of rows: 1, number of positions: 3, number of connections: 3, product range: PCV 6/..-G, pitch: 7.62 mm, mounting: Wave soldering, pin layout: Linear pinning, solder pin [P]: 2.6 mm, number of solder pins per potential: 3, plug-in system: COMBICON PC 6, Pin connector pattern alignment: Standard, locking: without, mounting: without, type of packaging: packed in cardboard

Phoenix Contact 2024 © - all rights reserved
<https://www.phoenixcontact.com>

PHOENIX CONTACT s.r.o.
Námestie Mateja Korvína 1
811 07 Bratislava
+421 2 3210 1470
obchod.sk@phoenixcontact.com