

Article datasheet

SEMS Screw DIN6900-3 Z4-1 M4x6 Galv. ST 4.8 Washer + Spring Lock Washer

Article-No.: 081.57.426

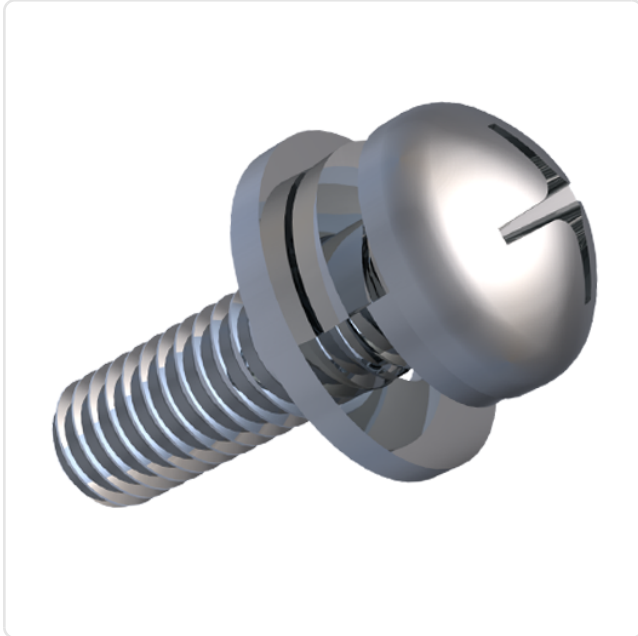
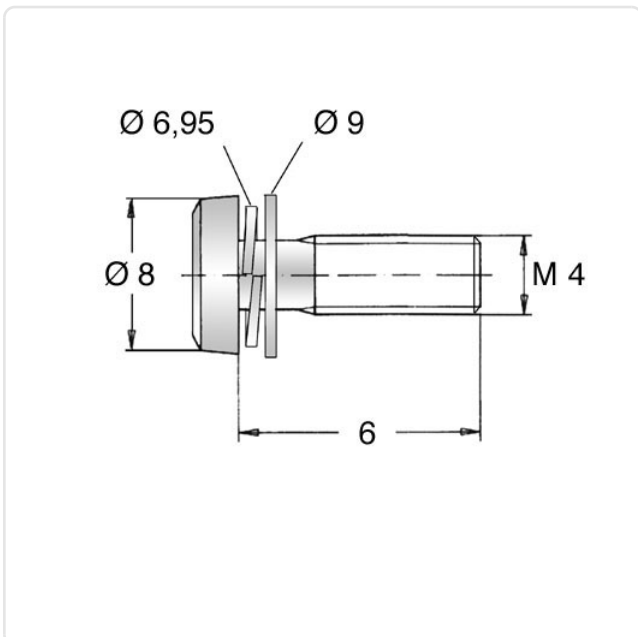

Image may be similar

Actuator Size:	Phillips PH2
Combination:	Washer DIN6902-1 and Spring Lock Washer DIN6905
DIN/ISO:	DIN7985 / ISO7045
Drive Type:	Cross Recess / Phillips-H
Finish:	Galvanized, Blue, 5 µm, A2K
Head Diameter [mm]:	8
Head Height [mm]:	3.1
Head Shape:	Pan Head
Length [mm]:	6
Material:	Steel 4.8
Thread Size:	M4
Weight:	1.74g
Conformities:	



You can find all information on the web on our article detail page

Would you like individual advice?

We look forward to your email to products@ettinger.de.

Subject to change and errors.