

VPC-5640S

Smart In-Vehicle & AMR BOX PC

User's Manual 3rd Ed

Copyright Notice

This document is copyrighted, 2024. All rights are reserved. The original manufacturer reserves the right to make improvements to the products described in this manual at any time without notice.

No part of this manual may be reproduced, copied, translated, or transmitted in any form or by any means without the prior written permission of the original manufacturer. Information provided in this manual is intended to be accurate and reliable. However, the original manufacturer assumes no responsibility for its use, or for any infringements upon the rights of third parties that may result from its use.

The material in this document is for product information only and is subject to change without notice. While reasonable efforts have been made in the preparation of this document to assure its accuracy, AAEMON assumes no liabilities resulting from errors or omissions in this document, or from the use of the information contained herein.

AAEMON reserves the right to make changes in the product design without notice to its users.

Acknowledgement

All other products' name or trademarks are properties of their respective owners.

- Microsoft Windows is a registered trademark of Microsoft Corp.
- Intel® is a registered trademark of Intel Corporation
- Intel® Core™ is a trademark of Intel Corporation
- ITE is a trademark of Integrated Technology Express, Inc.

All other product names or trademarks are properties of their respective owners.

Packing List

Before setting up your product, please make sure the following items have been shipped:

Item	Quantity
• VPC-5640S	1
• Wallmount Bracket	2
• Screw Package	1
• 3 Pin DC-in Power Connector	1

If any of these items are missing or damaged, please contact your distributor or sales representative immediately.

About this Document

This User's Manual contains all the essential information, such as detailed descriptions and explanations on the product's hardware and software features (if any), its specifications, dimensions, jumper/connector settings/definitions, and driver installation instructions (if any), to facilitate users in setting up their product.

Users may refer to the product page at AAEON.com for the latest version of this document.

Safety Precautions

Please read the following safety instructions carefully. It is advised that you keep this manual for future references

1. All cautions and warnings on the device should be noted.
2. All cables and adapters supplied by AAEON are certified and in accordance with the material safety laws and regulations of the country of sale. Do not use any cables or adapters not supplied by AAEON to prevent system malfunction or fires.
3. Make sure the power source matches the power rating of the device.
4. Position the power cord so that people cannot step on it. Do not place anything over the power cord.
5. Always completely disconnect the power before working on the system's hardware.
6. No connections should be made when the system is powered as a sudden rush of power may damage sensitive electronic components.
7. If the device is not to be used for a long time, disconnect it from the power supply to avoid damage by transient over-voltage.
8. Always disconnect this device from any AC supply before cleaning.
9. While cleaning, use a damp cloth instead of liquid or spray detergents.
10. Make sure the device is installed near a power outlet and is easily accessible.
11. Keep this device away from humidity.
12. Place the device on a solid surface during installation to prevent falls
13. Do not cover the openings on the device to ensure optimal heat dissipation.
14. Watch out for high temperatures when the system is running.
15. Do not touch the heat sink or heat spreader when the system is running
16. Never pour any liquid into the openings. This could cause fire or electric shock.

17. As most electronic components are sensitive to static electrical charge, be sure to ground yourself to prevent static charge when installing the internal components. Use a grounding wrist strap and contain all electronic components in any static-shielded containers.
18. If any of the following situations arises, please the contact our service personnel:
 - i. Damaged power cord or plug
 - ii. Liquid intrusion to the device
 - iii. Exposure to moisture
 - iv. Device is not working as expected or in a manner as described in this manual
 - v. The device is dropped or damaged
 - vi. Any obvious signs of damage displayed on the device
19. **DO NOT LEAVE THIS DEVICE IN AN UNCONTROLLED ENVIRONMENT WITH TEMPERATURES BEYOND THE DEVICE'S PERMITTED STORAGE TEMPERATURES (SEE CHAPTER 1) TO PREVENT DAMAGE.**

FCC Statement

Warning!



This device complies with Part 15 FCC Rules. Operation is subject to the following two conditions: (1) this device may not cause harmful interference, and (2) this device must accept any interference received including interference that may cause undesired operation.

Caution:

There is a danger of explosion if the battery is incorrectly replaced. Replace only with the same or equivalent type recommended by the manufacturer. Dispose of used batteries according to the manufacturer's instructions and your local government's recycling or disposal directives.

Attention:

Il y a un risque d'explosion si la batterie est remplacée de façon incorrecte. Ne la remplacer qu'avec le même modèle ou équivalent recommandé par le constructeur. Recycler les batteries usées en accord avec les instructions du fabricant et les directives gouvernementales de recyclage.

China RoHS Requirements (CN)

产品中有毒有害物质或元素名称及含量

AAEON System

QQ4-381 Rev.A2

部件名称	有毒有害物质或元素					
	铅 (Pb)	汞 (Hg)	镉 (Cd)	六价铬 (Cr(VI))	多溴联苯 (PBB)	多溴二苯醚 (PBDE)
印刷电路板 及其电子组件	×	○	○	○	○	○
外部信号 连接器及线材	×	○	○	○	○	○
外壳	○	○	○	○	○	○
中央处理器 与内存	×	○	○	○	○	○
硬盘	×	○	○	○	○	○
液晶模块	×	○	○	○	○	○
光驱	×	○	○	○	○	○
触控模块	×	○	○	○	○	○
电源	×	○	○	○	○	○
电池	×	○	○	○	○	○

本表格依据 SJ/T 11364 的规定编制。

○：表示该有毒有害物质在该部件所有均质材料中的含量均在 GB/T 26572 标准规定的限量要求以下。

×：表示该有害物质的某一均质材料超出了 GB/T 26572 的限量要求，然而该部件仍符合欧盟指令 2011/65/EU 的规范。

环保使用期限(EFUP (Environmental Friendly Use Period)) : 10 年

备注：

一、此产品所标示之环保使用期限，系指在一般正常使用状况下。

二、上述部件物质中央处理器、内存、硬盘、光驱、电源为选购品。

三、上述部件物质液晶模块、触控模块仅一体机产品适用。

China RoHS Requirement (EN)

Name and content of hazardous substances in product

AAEON System

QO4-381 Rev.A2

Part Name	Hazardous Substances					
	铅 (Pb)	汞 (Hg)	镉 (Cd)	六价铬 (Cr(VI))	多溴联苯 (PBB)	多溴二苯醚 (PBDE)
PCB Assemblies	×	○	○	○	○	○
Connector and Cable	×	○	○	○	○	○
Chassis	○	○	○	○	○	○
CPU and Memory	×	○	○	○	○	○
Hard Disk	×	○	○	○	○	○
LCD Modules	×	○	○	○	○	○
CD-ROM/DVD-ROM	×	○	○	○	○	○
Touch Modules	×	○	○	○	○	○
Power	×	○	○	○	○	○
Battery	×	○	○	○	○	○

The table is prepared in accordance with the provisions of SJ/T 11364.

○ : Indicates that said hazardous substance contained in all of the homogenous materials for this product is below the limit requirement of GB/T 26572.

× : Indicates that said hazardous substance contained in at least one of the homogenous materials used for this part is above the limit requirement of GB/T 26572. But this product still be compliance with 2011/65/EU Directive (allowed with 2011/65/EU Annex III of RoHS exemption with number 6(c),7(a),7(c)-1).

EFUP (Environment Friendly Use Period) value: 10 years.

Notes:

1. This product defined period of use is under normal condition.
2. In above part, CPU/Memory/ Hard Disk/CD-ROM/DVD-ROM/ Power are optional.
3. In above part, LCD Modules/ Touch Modules are for all-in-one product model.

Table of Contents

Chapter 1 - Product Specifications	1
1.1 Specifications.....	2
Chapter 2 – Hardware Information	5
2.1 Dimensions	6
2.2 Jumpers and Connectors	7
2.3 List of Jumpers	9
2.3.1 CMOS Control Selection (JP1)	9
2.3.2 Auto-Power Button Selection (JP2)	9
2.4 List of Connectors	10
2.4.1 Dual HDMI Port (CN1).....	12
2.4.2 Isolated CANBus FD Connector (CN22).....	14
2.4.3 ACC ON/OFF Delay Time Setting Switch (SW3/SW4).....	15
2.4.4 I/O Board-to-Board Connector (CN24)	18
2.4.5 Reset Button (SW2).....	19
2.4.6 2.5GbE LAN (CN3).....	20
2.4.7 2.5GbE LAN PoE PSE Connector (CN25).....	21
2.4.8 2.5" SATA HDD Power Wafer Box (CN10).....	24
2.4.9 2.5" SATA HDD Connector (CN9)	25
2.4.10 DIO Wafer Box (CN10).....	25
2.4.11 M.2 2280 M-Key (CN14)	26
2.4.12 M.2 2230 E-Key (CN15).....	28
2.4.13 M.2 3052 B-Key (A) (CN16)	30
2.4.14 M.2 3052 B-Key (B) (CN17).....	32
2.4.15 Micro SIM Slot for M.2 3052 B-Key (SIM1/2/3/4)	34
2.4.16 USB 2.0 x 2 Connector (CN19)	36
2.4.17 USB 3.2 x 2 Connector (CN18)	37

2.4.18	USB 2.0 x 2 Wafer Box (CN20/CN21)	38
2.4.19	Audio Jack Connector (CN23)	39
2.4.20	Phoenix Connector Power Input (CN26)	40
2.4.21	COM 1/COM 2 Wafer Box (CN12/CN13)	40
2.4.22	RTC Battery (BAT1)	41
2.4.23	Power Button (SW1)	42
2.4.24	GPS & IMU Sensor Board Connector (CN30)	43
2.5	Memory RAM Module Installation	44
2.6	2.5" SATA Drive Installation	45
2.7	M.2 Expansion Module Installation	46
Chapter 3 - AMI BIOS Setup		48
3.1	System Test and Initialization	49
3.2	AMI BIOS Setup	50
3.3	Setup Submenu: Main	51
3.4	Setup Submenu: Advanced	52
3.4.1	CPU Configuration	53
3.4.2	Memory Configuration	54
3.4.3	PCH-FW Configuration	55
3.4.3.1	Firmware Update Configuration	56
3.4.4	Hardware Monitor	57
3.4.5	Power Management	58
3.4.6	AAEON BIOS Robot	59
3.4.6.1	Device Detecting Configuration	61
3.5	Setup Submenu: System I/O	67
3.5.1	Storage Configuration	68
3.5.2	HD Audio Configuration	69
3.5.3	Digital IO Port Configuration	70
3.5.4	Legacy Logical Devices Configuration	72

3.5.4.1	Serial Port 1	73
3.5.4.2	Serial Port 2	74
3.5.5	Serial Port Console Redirection.....	75
3.5.5.1	Console Redirection Settings (COM0).....	76
3.5.5.2	Console Redirection Settings (Out-of-Band Mgmt)	79
3.6	Setup Submenu: Security	81
3.6.1	Trusted Computing	82
3.6.2	Secure Boot.....	84
3.6.2.1	Key Management.....	85
3.7	Setup Submenu: Boot.....	87
3.7.1	UEFI BBS Priorities.....	88
3.8	Setup Submenu: Save & Exit	89
3.9	Setup Submenu: MEBx.....	90
Chapter 4	– Driver Installation.....	91
4.1	Drivers Download and Installation.....	92
Appendix A	- I/O Information.....	95
A.1	I/O Address Map.....	96
A.2	Memory Address Map	97
A.3	IRQ Mapping Chart	98

Chapter 1

Product Specifications

1.1 Specifications

System

Form Factor	Multi-PoE & Fanless Appliance
Processor	Default: 12th Generation Intel® Core™ i7-1265UE Processor Project Based: Intel® Core™ i5-1245UE Intel® Core™ i3-1215UE
Chipset	—
Main Memory	DDR5 SODIMM x 2, up to 64GB
Display	HDMI x 2
Ethernet	2.5GbE x 1 (Intel® Ethernet Controller I226-LM)
Smart PoE	2.5GbE x 4 (IEEE 802.3 at/af, sharing total 60W of power budget for every four PoE ports) Note: System only supports total 20W PoE when input voltage is at or below 10V
RAID support	—
Expansion Slot	M.2 2230 E-Key x 1 (PCIe [x1] + USB 2.0, for Wi-Fi/Bluetooth Module) M.2 3052 B-Key w/ Dual-SIM x 2 (USB 3.0 + USB 2.0, for LTE/5G Module) M.2 2280 M-Key x 1 (PCIe [x4]), support NVME PCIe [x4] SSD)
GPS, G-Sensor	VS: Built-in GPS, NEO-M9V & G-Sensor
Front I/O Panel	USB 3.2 Gen 2 (Type-A) x 2 USB 2.0 (Type-A) x 2 2.5GbE LAN x 1

System

Front I/O Panel	2.5GbE PoE LAN x 4 (IEEE 802.3 at/af) Audio Jack x 1 for Line-out & MIC-in Reset Button x 1 Power Button x 1
Rear I/O Panel	DB-9 Male x 2 for RS-232/422/485 DB-9 Male x 1 for Isolated CANBus FD x 2 DB-15 Male x 1 for 8-bit DIO HDMI 1.4b x 2 3-pin Terminal Block x 1 DIP Switch x 1 SIM Slot x 4

Storage

HDD Tray	2.5" HDD/SSD Bay x 1
CF/CFast/mSATA Slot	—

Environmental

Operating Temperature	-40°F ~ 158°F (-40°C ~ 70°C), IEC68-2 with 0.5 m/s AirFlow w/Industrial Wide Temp Storage (-40°F ~ 185°F (-40°C ~ 85°C))/memory (-40°F ~ 203°F ((-40°C ~ 95°C))
Storage Temperature	-40°F ~ 176°F (-40°C ~ 80°C)
Storage Humidity	5 ~ 95% @ 40°C, non-condensing
Vibration/Shock	MIL-STD-810H
Certification	CE/FCC Class A, UKCA, E-Mark

Power Requirement

Power Supply	IS: 9V ~ 36V DC-in x 1 via 3-pin Terminal Block VS: 9V ~ 36V DC-in x 1 via 3-pin Terminal Block with power ignition
---------------------	--

Mechanical

Removable HDD Tray	—
Internal System HDD Bay	2.5" HDD/SSD Bay x 1
Dimension	Without Brackets: 9.45" x 6.58" x 2.99" (240mm x 167.1mm x 76mm) With Brackets: 11.69" x 6.58" x 3.27" (297mm x 167.1mm x 83mm)
Gross Weight	7.93 lb. (3.6 Kg)

1. Under harsh environments, please use industrial-grade SSDs and memory modules.
2. Helps to record vehicle movement status, providing flexible connectivity and scalability.

Chapter 2

Hardware Information

2.1 Dimensions

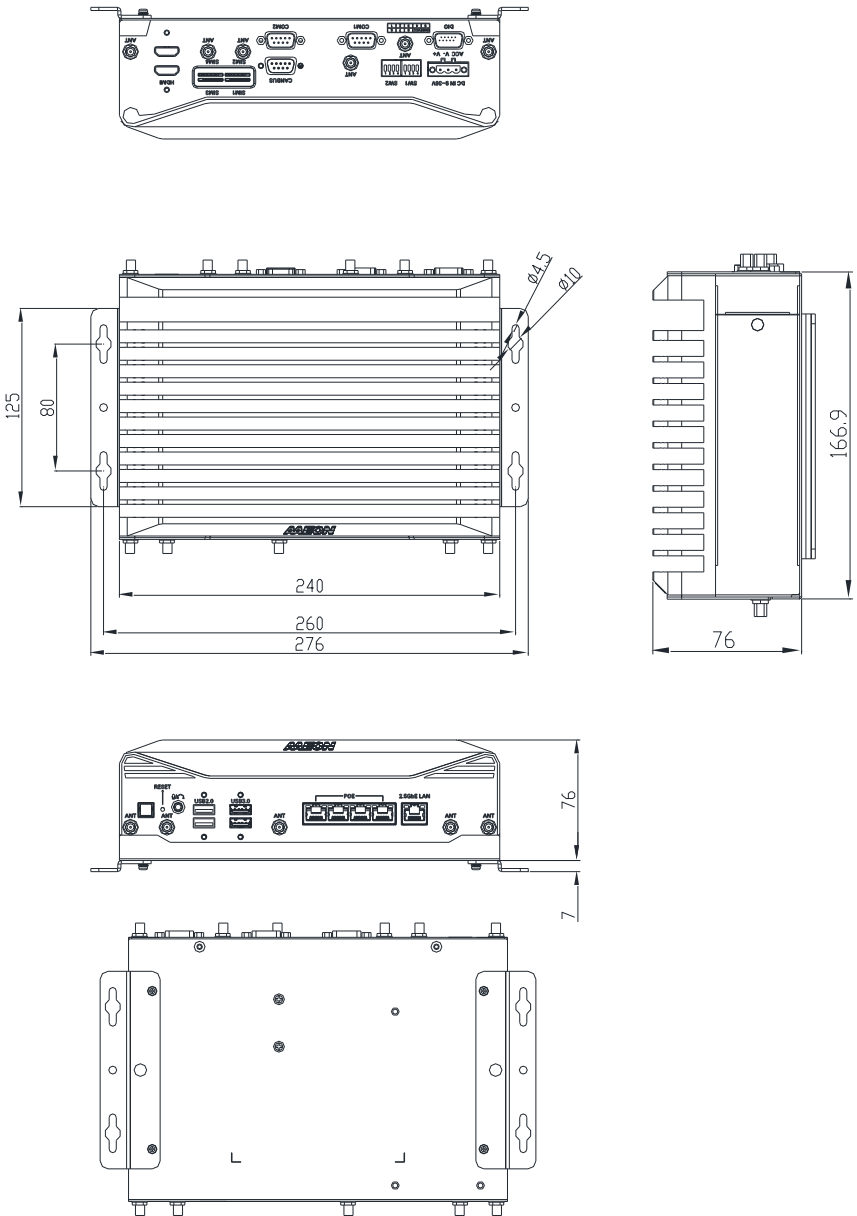

2.2 Jumpers and Connectors

Top Side

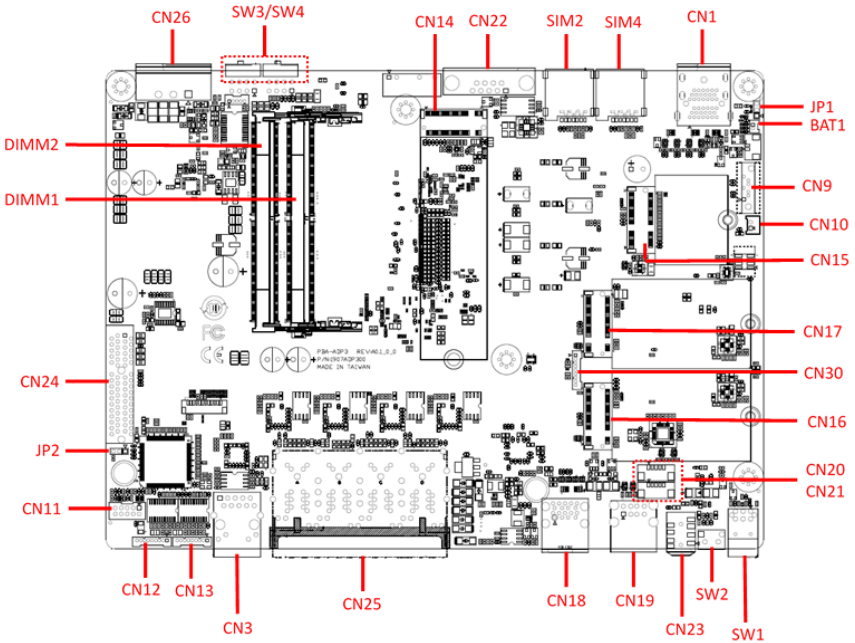

Bottom Side

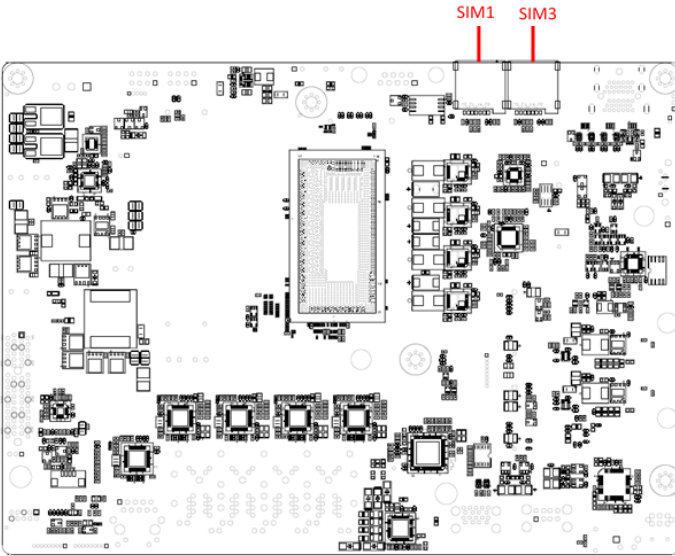

2.3 List of Jumpers

Please refer to the table below for all of the system's jumpers that you can configure for your application.

Label	Function
JP1	CMOS Control Selection
JP2	Auto-Power Button Selection

2.3.1 CMOS Control Selection (JP1)

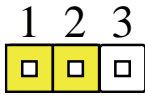

Normal (Default)

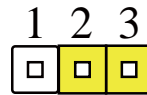

Clear CMOS

2.3.2 Auto-Power Button Selection (JP2)

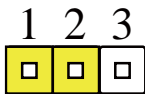

ATX (Default)

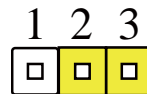

AT

2.4 List of Connectors

Please refer to the table below for all of the system's connectors that you can configure for your application

Label	Function
CN1	Dual HDMI Port
CN22	Isolated CANBus FD Connector
CN14	M.2 2280 M-Key
SW3/SW4	ACC ON/OFF Delay Time Setting Switch
CN26	Phoenix Connector Power Input
CN24	I/O Board-to-Board Connector
CN11	DIO Wafer Box
CN12	COM 1 Wafer Box RS-232/422/485
CN13	COM 2 Wafer Box RS-232/422/485
CN3	2.5GbE LAN
CN25	2.5GbE LAN PoE PSE Connector
CN18	USB 3.2 x 2 Connector
CN19	USB 2.0 x 2 Connector
CN23	Audio Jack Connector
SW2	Reset Button
SW1	Power Button
CN20 / CN21	USB 2.0 x 2 Wafer Box
CN16	M.2 3052 B-Key (A)
CN17	M.2 3052 B-Key (B)
CN15	M.2 2230 E-Key
CN30	GPS & IMU Sensor Board Connector
CN10	2.5" SATA HDD Power Wafer Box
CN9	2.5" SATA HDD Connector
BAT1	RTC Battery
SIM1	Micro SIM Slot for M.2 3052 B-Key (A)

Label	Function
SIM2	Micro SIM Slot for M.2 3052 B-Key (A)
SIM3	Micro SIM Slot for M.2 3052 B-Key (B)
SIM4	Micro SIM Slot for M.2 3052 B-Key (B)
DIMM1	DDR5 SODIMM Slot
DIMM2	DDR5 SODIMM Slot

2.4.1 Dual HDMI Port (CN1)

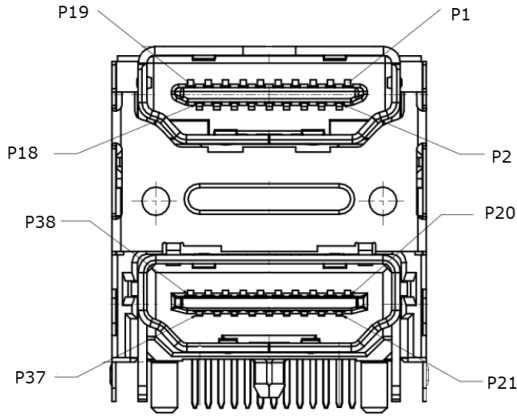

Pin	Pin Name	Signal Type	Signal level
P1	HDMI1_DATA2_P	DIFF	
P2	GND	GND	
P3	HDMI1_DATA2_N	DIFF	
P4	HDMI1_DATA1_P	DIFF	
P5	GND	GND	
P6	HDMI1_DATA1_N	DIFF	
P7	HDMI1_DATA0_P		
P8	GND	GND	
P9	HDMI1_DATA0_n		
P10	HDMI1_CLK_P	DIFF	
P11	GND	GND	
P12	HDMI1_CLK_N	DIFF	
P13	CEC		3.3V
P14	NC		
P15	HDMI1_SCL		
P16	HDMI1_SDA		

Pin	Pin Name	Signal Type	Signal level
P17	GND	GND	
P18	+V5S_HDMI_CON	PWR	5V
P19	HDMI1_HPD		5V
P20	HDMI2_DATA2_P		
P21	GND	GND	
P22	HDMI2_DATA2_N		
P23	HDMI2_DATA1_P		
P24	GND	GND	
P25	HDMI2_DATA1_N		
P26	HDMI2_DATA0_P		
P27	GND	GND	
P28	HDMI2_DATA0_N		
P29	HDMI2_CLK_P		
P30	GND	GND	
P31	HDMI2_CLK_N		
P32	CEC		3.3V
P33	NC		
P34	HDMI2_SCL		
P35	HDMI2_SDA		
P36	GND	GND	
P37	+V5S_HDMI_CON		5V
P38	HDMI2_HPD		5V

2.4.2 Isolated CANBus FD Connector (CN22)

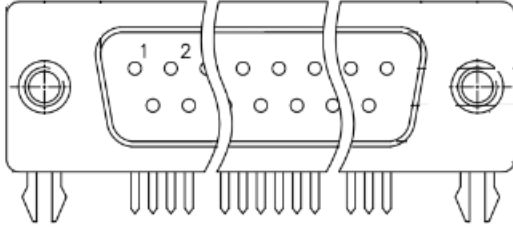

Pin	Pin Name	Signal Type	Signal level
P1	NC		
P2	CAN1L	CAN1L	
P3	GND_CAN	GND_CAN	
P4	CAN2L	CAN2L	
P5	GND_CAN	GND_CAN	
P6	NC		
P7	CAN1H	CAN1H	
P8	CAN2H	CAN2H	
P9	5VCC_CAN	+5V_CAN	

2.4.3 ACC ON/OFF Delay Time Setting Switch (SW3/SW4)

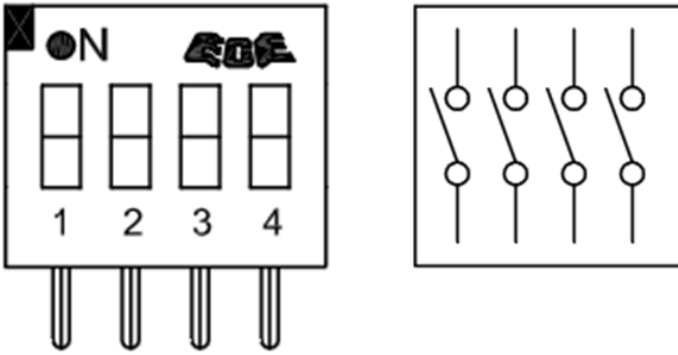

Pin	Signal	Pin	Signal
SW3			
1	ACC_ON_SET0	5	GND
2	ACC_ON_SET1	6	GND
3	ACC_ON_SET0	7	GND
4	AT_ATX_SEL	8	GND
SW4			
1	ACC_OFF_SET0	5	GND
2	ACC_OFF_SET1	6	GND
3	ACC_OFF_SET2	7	GND
4	PWR12V_EN	8	ISL81401A_EN

ACC ON Delay Minutes Setting Table

SW3 PIN NUMBER			Delay Time
5, 6	3, 4	1, 2	
OFF	OFF	OFF	1 sec.
OPEN	OPEN	OPEN	
OFF	OFF	ON	3 sec.
OPEN	OPEN	SHORT	
OFF	ON	OFF	5 sec.
OPEN	SHORT	OPEN	
OFF	ON	ON	10 sec.
OPEN	SHORT	SHORT	
ON	OFF	OFF	15 sec.
SHORT	OPEN	OPEN	
ON	OFF	ON	20 sec.
SHORT	OPEN	SHORT	
ON	ON	OFF	25 sec.
SHORT	SHORT	OPEN	
ON	ON	ON	30 sec.
SHORT	SHORT	SHORT	

AT/ATX OFF MODE Selection

SW3 PIN NUMBER	OFF MODE SEL
7, 8	ATX mode OFF
ON	
SHORT	AT mode OFF
OFF	
OPEN	

ACC OFF Delay Minutes Setting Table

SW4 PIN NUMBER			Delay Time
5, 6	3, 4	1, 2	
OFF	OFF	OFF	1 min.
OPEN	OPEN	OPEN	
OFF	OFF	ON	3 min.
OPEN	OPEN	SHORT	
OFF	ON	OFF	5 min.
OPEN	SHORT	OPEN	
OFF	ON	ON	10 min.
OPEN	SHORT	SHORT	
ON	OFF	OFF	30 min.
SHORT	OPEN	OPEN	
ON	OFF	ON	60 min.
SHORT	OPEN	SHORT	
ON	ON	OFF	120 min.
SHORT	SHORT	OPEN	
ON	ON	ON	0min.
SHORT	SHORT	SHORT	

MCU control setting

SW4 PIN NUMBER	
7, 8	MCU control
ON	
SHORT	Non MCU control
OFF	
OPEN	

Chassis Mark (SW1/SW2)

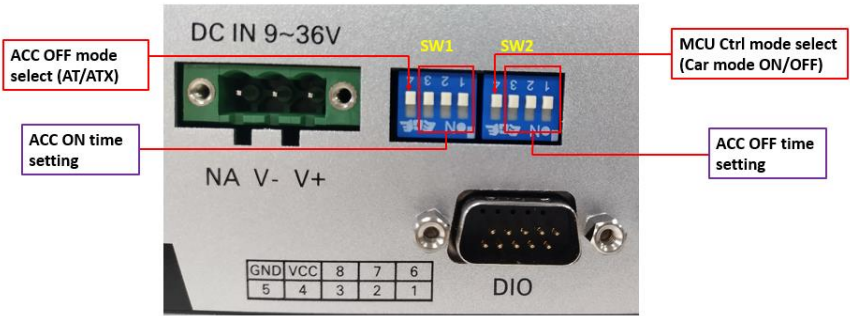

SW1 ACC ON time setting			
3	2	1	Delay time
OFF	OFF	OFF	1 sec
OFF	OFF	ON	3 sec
OFF	ON	OFF	5 sec
OFF	ON	ON	10 sec
ON	OFF	OFF	15 sec
ON	OFF	ON	20 sec
ON	ON	OFF	25 sec
ON	ON	ON	30 sec

SW2 ACC OFF time setting			
3	2	1	Delay time
OFF	OFF	OFF	1 min
OFF	OFF	ON	3 min
OFF	ON	OFF	5 min
OFF	ON	ON	10 min
ON	OFF	OFF	30 min
ON	OFF	ON	60 min
ON	ON	OFF	120 min
ON	ON	ON	0 min

SW2 MCU Ctrl mode select	
ON	MCU Ctrl (Car mode ON)
OFF	Non MCU Ctrl (Car mode OFF)

SW1 ACC OFF mode select (AT/ATX)	
ON	AT (Cut power source directly)
OFF	ATX (Normal power off)

2.4.4 I/O Board-to-Board Connector (CN24)

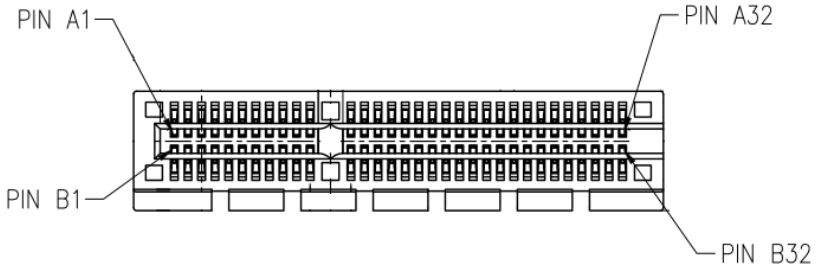

Pin	Pin Name	Signal Type	Signal level	Pin	Pin Name	Signal Type	Signal Level
A1	+V3P3S	PWR	+3.3V	B1	+V_IN	PWR	+9V~36V
A2	+V3P3S	PWR	+3.3V	B2	+V_IN	PWR	+9V~36V
A3	+V_IN	PWR	+9V~36V	B3	+V_IN	PWR	+9V~36V
A4	BTB_ESPI_CLK	IN		B4	+V5S	PWR	+5V
A5	BTB_ESPI_ALERT#	IN		B5	+V5S	PWR	+5V
A6	BTB_ESPI_CS1#	IN		B6	+V3P3A	PWR	+3.3V
A7	BTB_ESPI_IO_3	I/O		B7	+V3P3A	PWR	+3.3V
A8	BTB_ESPI_IO_2	I/O		B8	+V_IN	PWR	+9V~36V
A9	BTB_ESPI_IO_1	I/O		B9	BTB_GPIO2	OUT	
A10	BTB_ESPI_IO_0	I/O		B10	BTB_GPIO1	OUT	
A11	BUF_PLT_RST_BTBTB	IN		B11	BTB_WAKE#	OUT	
A12	GND	GND		B12	GND	GND	
A13	CLK_PCIE_SLOT0_P	DIFF		B13	PCIE9_TXP_C	DIFF	
A14	CLK_PCIE_SLOT0_N	DIFF		B14	PCIE9_TXN_C	DIFF	
A15	GND	GND		B15	GND	GND	
A16	PCIE9_RXP_R	DIFF		B16	PCIE10_TXP_C	DIFF	
A17	PCIE9_RXN_R	DIFF		B17	PCIE10_TXN_C	DIFF	
A18	GND	GND		B18	GND	GND	

Pin	Pin Name	Signal Type	Signal level	Pin	Pin Name	Signal Type	Signal Level
A19	PCIE10_RXP_R	DIFF		B19	BTB_I2C_SDA	I/O	
A20	PCIE10_RXN_R	DIFF		B20	BTB_I2C_SCL	IN	
A21	GND	GND		B21	GND	GND	
A22	CLK_PCIE_SLOT1_P	DIFF		B22	SMB_CLK	IN	
A23	CLK_PCIE_SLOT1_N	DIFF		B23	SMB_SATA	I/O	
A24	GND	GND		B24	GND	GND	
A25	USB_PP7	DIFF		B25	BTB_GPIO3	OUT	
A26	USB_PN7	DIFF		B26	BTB_GPIO4	OUT	
A27	GND	GND		B27	GND	GND	
A28	USB_PP6	DIFF		B28	USB_PP8	DIFF	
A29	USB_PN6	DIFF		B29	USB_PN8	DIFF	
A30	GND	GND		B30	GND	GND	
A31	STXD3X	IN		B31	STXD4X	IN	
A32	SRXD3X	OUT		B32	SRXD4X	OUT	

2.4.5 Reset Button (SW2)

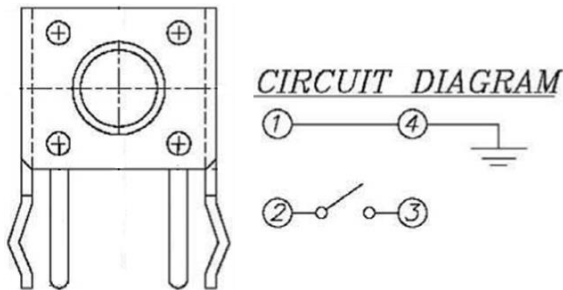

Pin	Pin Name	Signal Type	Signal level
1	GND	GND	
2	GND	GND	

Pin	Pin Name	Signal Type	Signal level
3	HWRST#	OUT	+3.3V
4	GND	GND	

2.4.6 2.5GbE LAN (CN3)

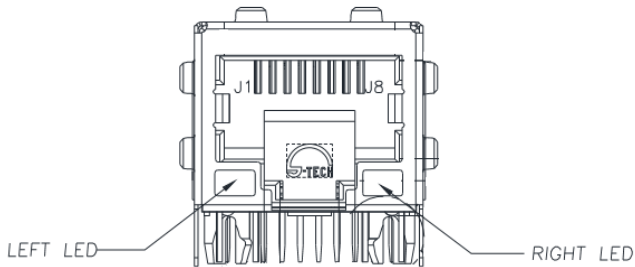

Pin	Pin Name	Signal Type	Signal level
1	GND	GND	
2	LAN1_MDI0P	DIFF	
3	LAN1_MDI0N	DIFF	
4	LAN1_MDI1P	DIFF	
5	LAN1_MDI1N	DIFF	
6	LAN1_MDI2P	DIFF	
7	LAN1_MDI2N	DIFF	
8	LAN1_MDI3P	DIFF	
9	LAN1_MDI3N	DIFF	
10	GND	GND	
11	LAN1_LED_1K	IN	+3.3V
12	LAN1_LED_2K5	IN	+3.3V
13	LAN1_LED_Y	IN	+3.3V
14	LAN1_LED_LNK#_ACT	IN	+3.3V

2.4.7 2.5GbE LAN PoE PSE Connector (CN25)

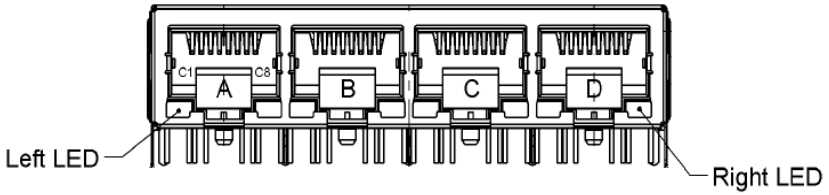

Pin	Pin Name	Signal Type	Signal level
A			
1R1	LAN2_MDI0P	DIFF	
1R2	LAN2_MDI0N	DIFF	
1R3	1TRCT1	GND	
1R4	LAN2_MDI1P	DIFF	
1R5	LAN2_MDI1N	DIFF	
1R6	1TRCT2	GND	
1R7	LAN2_MDI2P	DIFF	
1R8	LAN2_MDI2N	DIFF	
1R9	1TRCT3	GND	
1R10	LAN2_MDI3P	DIFF	
1R11	LAN2_MDI3N	DIFF	
1R12	1TRCT4	GND	
1R13	1VC3	PWR_PoE	+52V
1R14	1VC4	PWR_PoE	+52V
1R15	1VC2	PWR_PoE	+52V
1R16	1VC1	PWR_PoE	+52V
1L1	LAN2_LED_LNK#_ACT	IN	+3.3V
1L2	LAN2_LED_Y	IN	+3.3V
1L3	LAN2_LED_1K	IN	+3.3V

Pin	Pin Name	Signal Type	Signal level
1L4	LAN2_LED_2K5	IN	+3.3V
B			
2R1	LAN3_MDI0P	DIFF	
2R2	LAN3_MDI0N	DIFF	
2R3	2TRCT1	GND	
2R4	LAN3_MDI1P	DIFF	
2R5	LAN3_MDI1N	DIFF	
2R6	2TRCT2	GND	
2R7	LAN3_MDI2P	DIFF	
2R8	LAN3_MDI2N	DIFF	
2R9	2TRCT3	GND	
2R10	LAN3_MDI3P	DIFF	
2R11	LAN3_MDI3N	DIFF	
2R12	2TRCT4	GND	
2R13	2VC3	PWR_PoE	+52V
2R14	2VC4	PWR_PoE	+52V
2R15	2VC2	PWR_PoE	+52V
2R16	2VC1	PWR_PoE	+52V
2L1	LAN3_LED_LNK#_ACT	IN	+3.3V
2L2	LAN3_LED_Y	IN	+3.3V
2L3	LAN3_LED_1K	IN	+3.3V
2L4	LAN3_LED_2K5	IN	+3.3V
C			
3R1	LAN4_MDI0P	DIFF	
3R2	LAN4_MDI0N	DIFF	
3R3	3TRCT1	GND	
3R4	LAN4_MDI1P	DIFF	
3R5	LAN4_MDI1N	DIFF	
3R6	3TRCT2	GND	

Pin	Pin Name	Signal Type	Signal level
3R7	LAN4_MDI2P	DIFF	
3R8	LAN4_MDI2N	DIFF	
3R9	3TRCT3	GND	
3R10	LAN4_MDI3P	DIFF	
3R11	LAN4_MDI3N	DIFF	
3R12	3TRCT4	GND	
3R13	3VC3	PWR_PoE	+52V
3R14	3VC4	PWR_PoE	+52V
3R15	3VC2	PWR_PoE	+52V
3R16	3VC1	PWR_PoE	+52V
3L1	LAN4_LED_LNK#_ACT	IN	+3.3V
3L2	LAN4_LED_Y	IN	+3.3V
3L3	LAN4_LED_1K	IN	+3.3V
3L4	LAN4_LED_2K5	IN	+3.3V
D			
4R1	LAN5_MDI0P	DIFF	
4R2	LAN5_MDI0N	DIFF	
4R3	4TRCT1	GND	
4R4	LAN5_MDI1P	DIFF	
4R5	LAN5_MDI1N	DIFF	
4R6	4TRCT2	GND	
4R7	LAN5_MDI2P	DIFF	
4R8	LAN5_MDI2N	DIFF	
4R9	4TRCT3	GND	
4R10	LAN5_MDI3P	DIFF	
4R11	LAN5_MDI3N	DIFF	
4R12	4TRCT4	GND	
4R13	4VC3	PWR_PoE	+52V
4R14	4VC4	PWR_PoE	+52V

Pin	Pin Name	Signal Type	Signal level
4R15	4VC2	PWR_PoE	+52V
4R16	4VC1	PWR_PoE	+52V
4L1	LAN5_LED_LNK#_ACT	IN	+3.3V
4L2	LAN5_LED_Y	IN	+3.3V
4L3	LAN5_LED_1K	IN	+3.3V
4L4	LAN5_LED_2K5	IN	+3.3V

2.4.8 2.5" SATA HDD Power Wafer Box (CN10)

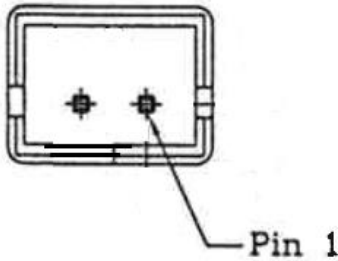

Pin	Pin Name	Signal Type	Signal level
1	+V5S	PWR	+5V
2	GND	GND	

2.4.9 2.5" SATA HDD Connector (CN9)

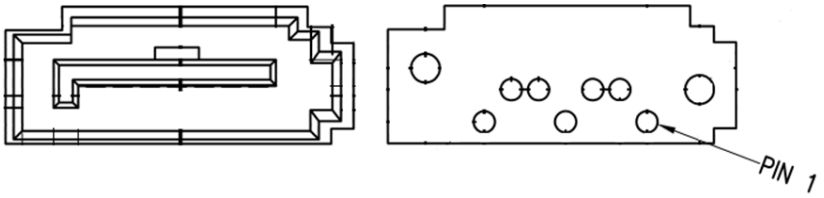

Pin	Pin Name	Signal Type	Signal level
1	GND	GND	
2	SATA0_TXP	DIFF	
3	SATA0_TXN	DIFF	
4	GND	GND	
5	SATA0_RXN	DIFF	
6	SATA0_RXP	DIFF	
7	GND	GND	

2.4.10 DIO Wafer Box (CN10)

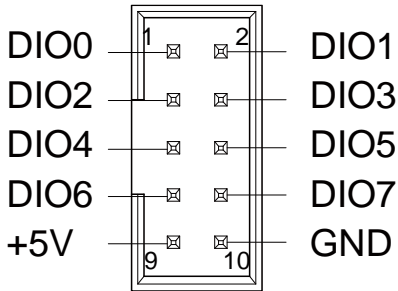

Pin	Pin Name	Signal Type	Signal level
1	DIO0	I/O	+5V
2	DIO1	I/O	+5V

Pin	Pin Name	Signal Type	Signal level
3	DIO2	I/O	+5V
4	DIO3	I/O	+5V
5	DIO4	I/O	+5V
6	DIO5	I/O	+5V
7	DIO6	I/O	+5V
8	DIO7	I/O	+5V
9	+5V	PWR	+5V
10	GND	GND	

2.4.11 M.2 2280 M-Key (CN14)

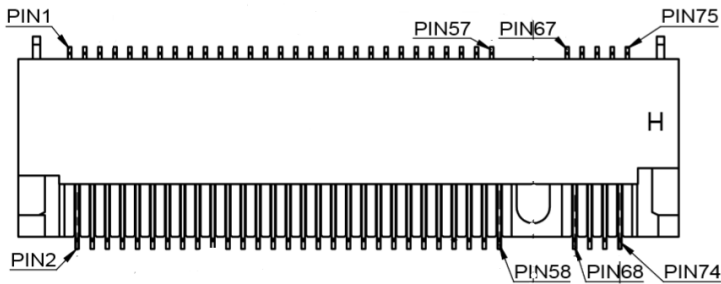

Pin	Pin Name	Signal Type	Signal level	Pin	Pin Name	Signal Type	Signal Level
1	GND	GND		2	+V3P3_NGFF	PWR	+3.3V
3	GND	GND		4	+V3P3_NGFF	PWR	+3.3V
5	PCIE4_3_RXN	IN		6	CARD_PWR_OFF_N	OUT	+3.3V
7	PCIE4_3_RXP	IN		8	NC		
9	GND	GND		10	NC		
11	PCIE4_3_TXN	OUT		12	+V3P3_NGFF	PWR	+3.3V
13	PCIE4_3_TXP	OUT		14	+V3P3_NGFF	PWR	+3.3V
15	GND	PWR		16	+V3P3_NGFF	PWR	+3.3V
17	PCIE4_2_RXN	IN		18	+V3P3_NGFF	PWR	+3.3V

Pin	Pin Name	Signal Type	Signal level	Pin	Pin Name	Signal Type	Signal Level
19	PCIE4_2_RXP	IN		20	NC		
21	GND	PWR		22	NC		
23	PCIE4_2_TXN	OUT		24	NC		
25	PCIE4_2_TXP	OUT		26	NC		
27	GND	PWR		28	NC		
29	PCIE4_1_RXN	IN		30	NC		
31	PCIE4_1_RXP	IN		32	NC		
33	GND	GND		34	NC		
35	PCIE4_1_TXN	OUT		36	NC		
37	PCIE4_1_TXP	OUT		38	DEV_SLP	IN	+3.3V
39	GND	GND		40	SMB_CLK_M2		+1.8V
41	PCIE4_0_RXP	IN		42	SMB_DATA_M2		+1.8V
43	PCIE4_0_RXN	IN		44	NC		
45	GND	GND		46	NC		
47	PCIE4_0_TXN	OUT		48	NC		
49	PCIE4_0_TXP	OUT		50	BUF_PLT_RST_R	IN	+3.3V
51	GND	PWR		52	PCIE_CLKREQ#0	OUT	+3.3V
53	CLKOUT_PCIE_N0	OUT		54	M2_WAKE#	OUT	+3.3V
55	CLKOUT_PCIE_P0	OUT		56	NC		
57	GND	GND		58	NC		
67	NC			68	NC		
69	NC			70	+V3P3_NGFF	PWR	+3.3V
71	GND	GND		72	+V3P3_NGFF	PWR	+3.3V
73	GND	GND		74	+V3P3_NGFF	PWR	+3.3V
75	GND	GND					

2.4.12 M.2 2230 E-Key (CN15)

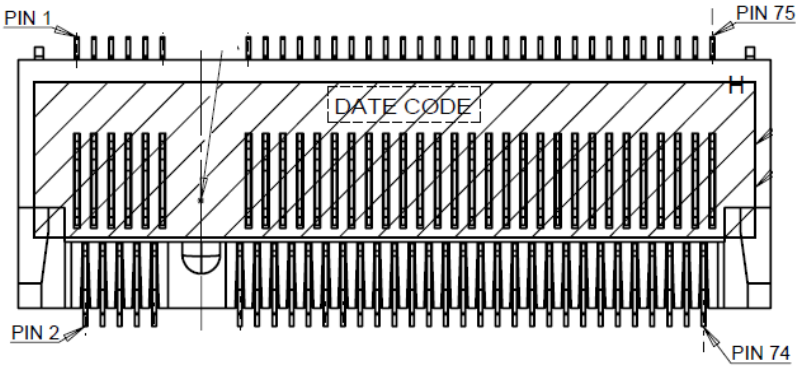

Pin	Pin Name	Signal Type	Pin	Pin Name	Signal Type	Signal Level
1	GND	GND	2	+V3P3_NGFF_E	PWR	+3.3V
3	USB_PP9	DIFF	4	+V3P3_NGFF_E	PWR	+3.3V
5	USB_PN9	DIFF	6	NC		
7	GND	GND	8	M.2_BT_PCMCLK_C	IN	+3.3V
9	NC		10	M.2_BT_PCMFRM_C	IN	+3.3V
11	NC		12	M.2_BT_PCMMIN_C	OUT	+3.3V
13	NC		14	M.2_BT_PCMOUT_C	IN	+3.3V
15	NC		16	NC		
17	NC		18	GND	GND	
19	NC		20	KEYE_UART_WAKE_N	OUT	+3.3V
21	NC		22	NC		
23	NC					
			32	NC		
33	GND	GND	34	NC		

Pin	Pin Name	Signal Type	Pin	Pin Name	Signal Type	Signal Level
35	PCIE5_TXP	DIFF	36	NC		
37	PCIE5_TXN	DIFF	38	CL_RST#	IN	+3.3V
39	GND	GND	40	CL_DATA		+3.3V
41	PCIE5_RXP	DIFF	42	CL_CLK	IN	+3.3V
43	PCIE5_RXN	DIFF	44	GPPC_F6_CNV_PA_BLANKING	OUT	+3.3V
45	GND	GND	46	CNV_MFUART2_TXD	IN	+3.3V
47	CLKOUT_PCIE_P4	DIFF	48	CNV_MFUART2_RXD	OUT	+3.3V
49	CLKOUT_PCIE_N4	DIFF	50	SUSCLK	IN	+3.3V
51	GND	GND	52	BUF_PLT_RST#	IN	+3.3V
53	PCIE_CLKREQ#4	OUT	54	GPP_A13_PMC_I2C_SCL	IN	+3.3V
55	KEYE_WAKE_N	OUT	56	GPPC_E3_CPU_GP_0	IN	+3.3V
57	GND	GND	58	SMB_DATA		
59	NC		60	SMB_CLK	IN	
61	NC		62	SMB_ALERT	IN	
63	GND	GND	64	NC		
65	NC		66	NC		
67	NC		68	NC		
69	GND	GND	70	NC		
71	NC		72	+V3P3_NGFF_E	PWR	+3.3V
73	NC		74	+V3P3_NGFF_E	PWR	+3.3V
75	GND	GND				

2.4.13 M.2 3052 B-Key (A) (CN16)

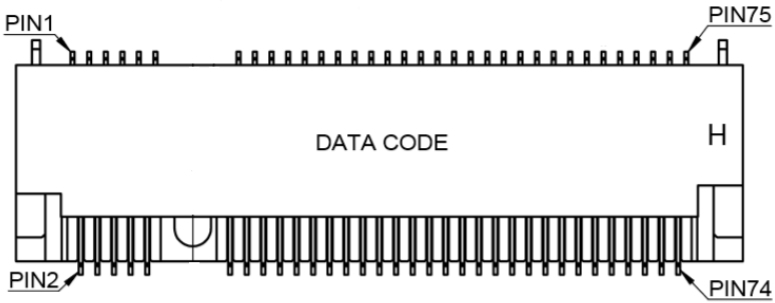

Pin	Pin Name	Signal Type	Pin	Pin Name	Signal Type	Signal Level
1	NC		2	+3P3V_NGFF_3052	PWR	+3.3V
3	GND	GND	4	+3P3V_NGFF_3052	PWR	+3.3V
5	GND	GND	6	FULL_CARD_POWER_A	OUT	+3.3V
7	USB_PP3	DIFF	8	3GPW_EN_A	IN	+3.3V
9	USB_PN3	DIFF	10	NC		
11	GND	GND	12			
			20	NC		
21	NC		22	NC		
23	NC		24	NC		
25	NC		26	NC		
27	GND	GND	28	NC		
29	USB3_RX3_N	DIFF	30	UIM1_RESET	OUT	
31	USB3_RX3_P	DIFF	32	UIM1_CLK	OUT	
33	GND	GND	34	UIM1_DATA	I/O	

Pin	Pin Name	Signal Type	Pin	Pin Name	Signal Type	Signal Level
35	USB3_TX3_N	DIFF	36	UIM1_PWR1	PWR	+3.3V
37	USB3_TX3_P	DIFF	38	NC		
39	GND	GND	40	UIM2_DET	IN	
41	NC		42	UIM2_DATA	OUT	
43	NC		44	UIM2_CLK	OUT	
45	GND	GND	46	UIM2_RESET	OUT	
47	NC		48	UIM2_PWR2	PWR	+3.3V
49	NC		50	BUF_PLT_3052A_RST#	IN	+3.3V
51	GND	GND	52	M3052A_PCIE_CLKREQ#		
53	NC	OUT	54	M2_3052A_WAKE#	OUT	+3.3V
55	NC	OUT	56	NC		
57	GND	GND	58	NC		
59	NC		60	NC		
61	NC		62	NC		
63	NC		64	NC		
65	NC		66	UIM1_DET	IN	
67	BUF_PLT_3052A_RST#		68	SUSCLK_3052A		
69	NC		70	+3P3V_NGFF_3052	PWR	+3.3V
71	GND	GND	72	+3P3V_NGFF_3052	PWR	+3.3V
73	GND	GND	74	+3P3V_NGFF_3052	PWR	+3.3V
75	GND	GND				

2.4.14 M.2 3052 B-Key (B) (CN17)

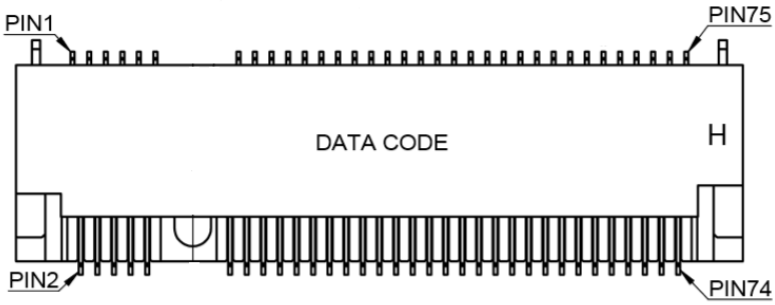

Pin	Pin Name	Signal Type	Pin	Pin Name	Signal Type	Signal Level
1	NC		2	+3P3V_NGFF_3052	PWR	+3.3V
3	GND	GND	4	+3P3V_NGFF_3052	PWR	+3.3V
5	GND	GND	6	FULL_CARD_POWER_B	OUT	+3.3V
7	USB_PP4	DIFF	8	3GPW_EN_B	IN	+3.3V
9	USB_PN4	DIFF	10	NC		
11	GND	GND	12			
			20	NC		
21	NC		22	NC		
23	NC		24	NC		
25	NC		26	NC		
27	GND	GND	28	NC		
29	USB3_RX4_N	DIFF	30	UIM3_RESET	OUT	
31	USB3_RX4_P	DIFF	32	UIM3_CLK	OUT	
33	GND	GND	34	UIM3_DATA	I/O	

Pin	Pin Name	Signal Type	Pin	Pin Name	Signal Type	Signal Level
35	USB3_TX4_N	DIFF	36	UIM3_PWR3	PWR	+3.3V
37	USB3_TX4_P	DIFF	38	NC		
39	GND	GND	40	UIM4_DET	IN	
41	NC		42	UIM4_DATA	OUT	
43	NC		44	UIM4_CLK	OUT	
45	GND	GND	46	UIM4_RESET	OUT	
47	NC		48	UIM4_PWR4	PWR	+3.3V
49	NC		50	BUF_PLT_3052B_RST#	IN	+3.3V
51	GND	GND	52	M3052B_PCIE_CLKREQ#		
53	NC	OUT	54	M2_3052B_WAKE#	OUT	+3.3V
55	NC	OUT	56	NC		
57	GND	GND	58	NC		
59	NC		60	NC		
61	NC		62	NC		
63	NC		64	NC		
65	NC		66	UIM3_DET	IN	
67	BUF_PLT_3052B_RST#		68	SUSCLK_3052B		
69	NC		70	+3P3V_NGFF_3052	PWR	+3.3V
71	GND	GND	72	+3P3V_NGFF_3052	PWR	+3.3V
73	GND	GND	74	+3P3V_NGFF_3052	PWR	+3.3V
75	GND	GND				

2.4.15 Micro SIM Slot for M.2 3052 B-Key (SIM1/2/3/4)

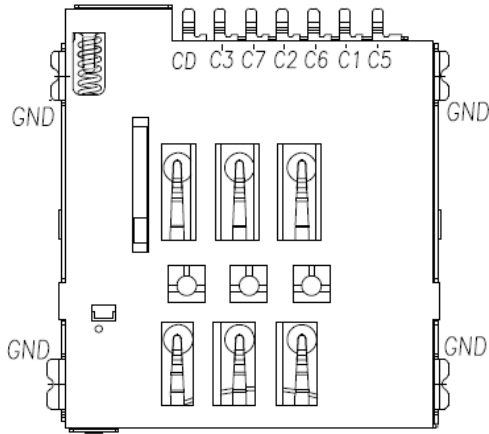

Pin	Pin Name	Signal Type	Signal level
M.2 3052 B-Key Slot A (SIM1)			
C1	UIM1_PWR	PWR	
C2	UIM1_RESET	IN	
C3	UIM1_CLK	IN	
C5	GND	GND	
C6	NC		
C7	UIM1_DATA	I/O	
CD	UIM1_DET_CD	OUT	
M.2 3052 B-Key Slot A (SIM2)			
C1	UIM2_PWR	PWR	
C2	UIM2_RESET	IN	
C3	UIM2_CLK	IN	
C5	GND	GND	
C6	NC		
C7	UIM2_DATA	I/O	

Pin	Pin Name	Signal Type	Signal level
CD	UIM2_DET_CD	OUT	
M.2 3052 B-Key Slot B (SIM3)			
C1	UIM3_PWR	PWR	
C2	UIM3_RESET	IN	
C3	UIM3_CLK	IN	
C5	GND	GND	
C6	NC		
C7	UIM3_DATA	I/O	
CD	UIM3_DET_CD	OUT	
M.2 3052 B-Key Slot B (SIM4)			
C1	UIM4_PWR	PWR	
C2	UIM4_RESET	IN	
C3	UIM4_CLK	IN	
C5	GND	GND	
C6	NC		
C7	UIM4_DATA	I/O	
CD	UIM4_DET_CD	OUT	

2.4.16 USB 2.0 x 2 Connector (CN19)

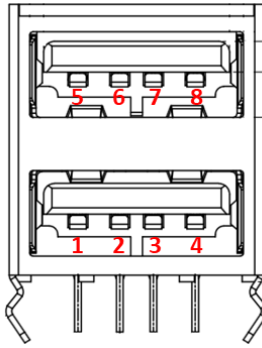

Pin	Pin Name	Signal Type	Signal level
1	VCC_USB3	PWR	+5V
2	USB3-	DIFF	
3	USB3+	DIFF	
4	GND	GND	
5	VCC_USB4	PWR	+5V
6	USB4-	DIFF	
7	USB4+	DIFF	
8	GND	GND	

2.4.17 USB 3.2 x 2 Connector (CN18)

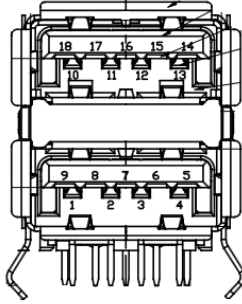

Pin	Pin Name	Signal Type	Signal level
1	VCC_USB1	PWR	+5V
2	USB1-	DIFF	
3	USB1+	DIFF	
4	GND	GND	
5	USB3_RX1_N_C	DIFF	
6	USB3_RX1_P_C	DIFF	
7	GND	GND	
8	USB3_TX1_N_C	DIFF	
9	USB3_TX1_P_C	DIFF	
10	VCC_USB2	PWR	+5V
11	USB2-	DIFF	
12	USB2+	DIFF	
13	GND	GND	
14	USB3_RX2_N_C	DIFF	
15	USB3_RX2_P_C	DIFF	
16	GND	GND	
17	USB3_TX2_N_C	DIFF	
18	USB3_TX2_P_C	DIFF	

2.4.18 USB 2.0 x 2 Wafer Box (CN20/CN21)

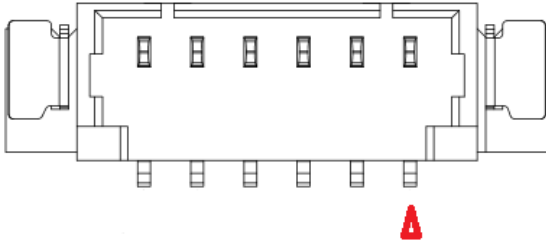

Pin	Pin Name	Signal Type	Signal level
1	+5V	GND	+5V
2	USBD-	DIFF	
3	USBD+	DIFF	
4	GND	GND	
5	GND	GND	

2.4.19 Audio Jack Connector (CN23)

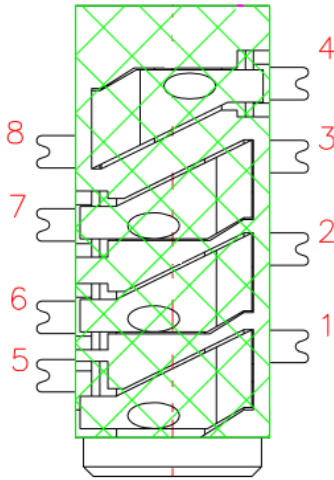

Pin	Pin Name	Signal Type	Signal level
1	MIC_R	IN	
2	AUD_GND	AUD_GND	
3	LOUT_R	OUT	
4	NC		
5	NC		
6	HP_DET_3	IN	
7	NC		
8	LOUT_L	OUT	

2.4.20 Phoenix Connector Power Input (CN26)

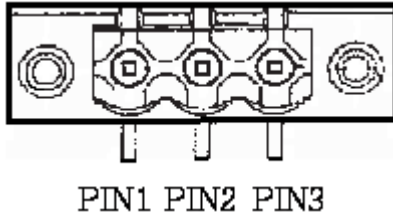

Pin	Pin Name	Signal Type	Signal level
1	VIN	PWR	+9V ~ +36V
2	GND	GND	
3	ACC_IN	OUT	

2.4.21 COM 1/COM 2 Wafer Box (CN12/CN13)

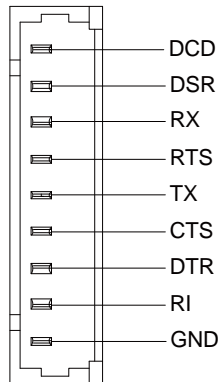

Pin	Pin Name	Signal Type	RS-422	RS-485
1	DCD	IN	RS422_TX-	RS485_D-
2	DSR	IN		

Pin	Pin Name	Signal Type	RS-422	RS-485
3	RX	IN	RS422_TX+	RS485_D+
4	RTS	OUT		
5	TX	OUT	RS422_RX+	
6	CTS	IN		
7	DTR	OUT	RS422_RX-	
8	RI (Default: Disable)	IN		
9	GND	GND		

2.4.22 RTC Battery (BAT1)

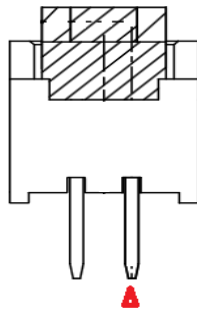

Pin	Pin Name	Signal Type	Signal level
1	+V3P3A_RTC	PWR	+3.3V
2	GND	GND	

2.4.23 Power Button (SW1)

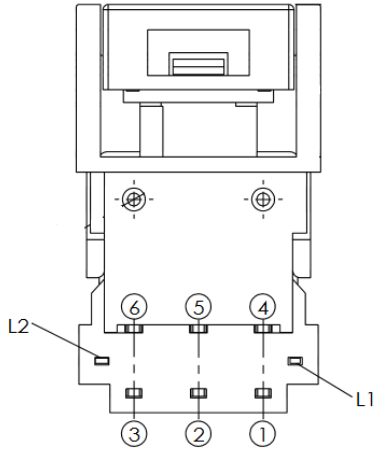

Pin	Pin Name	Signal Type	Signal level
1	NC		
2	GND	GND	
3	PWR_BUTTON#	OUT	
4	NC		
5	GND	GND	
6	PWR_BUTTON#	OUT	
L1	+V5S	PWR	+5V
L2	GND	GND	

2.4.24 GPS & IMU Sensor Board Connector (CN30)

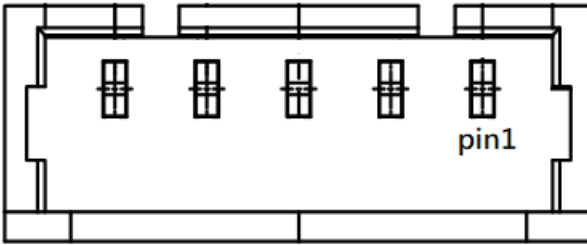

Pin	Pin Name	Signal Type	Signal level
1	+V3P3S	PWR	+3.3V
2	+V3P3S	PWR	+3.3V
3	I2C0_SCL	IN	
4	I2C0_SDA	I/O	
5	IMU_INT	OUT	
6	UART0_TXD	IN	
7	UART0_RXD	OUT	
8	GND	GND	
9	GND	GND	

2.5 Memory RAM Module Installation

Before installing the RAM, ensure the system is powered down and disconnect the power cord from the system.

Step 1: Remove the six (6) screws from the bottom of the chassis as shown in the figure below. Remove the bottom panel from the system. Note the placement of the RAM and expansion module slots.

Step 2: Place thermal pads on the RAM modules and insert them into the RAM slots. Note the figure below for placement of thermal pads. When inserting the modules into the RAM slots, first insert at an angle ($\sim 30^\circ$), then gently push down until secure.

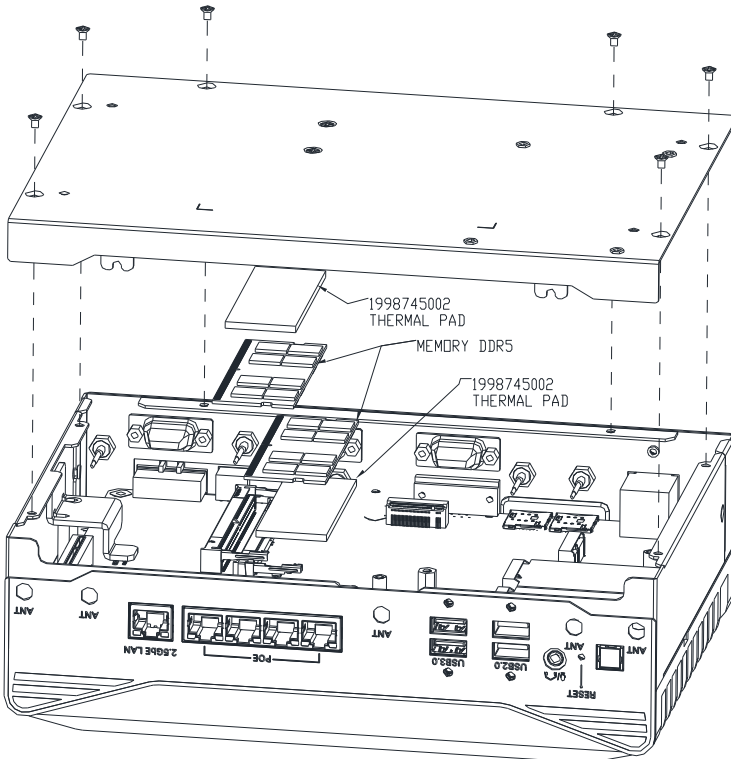

2.6 2.5" SATA Drive Installation

Step 1: Attach the SATA drive to the HDD Bracket using the four (4) screws provided. Please ensure each screw is accompanied by a damper, as shown.

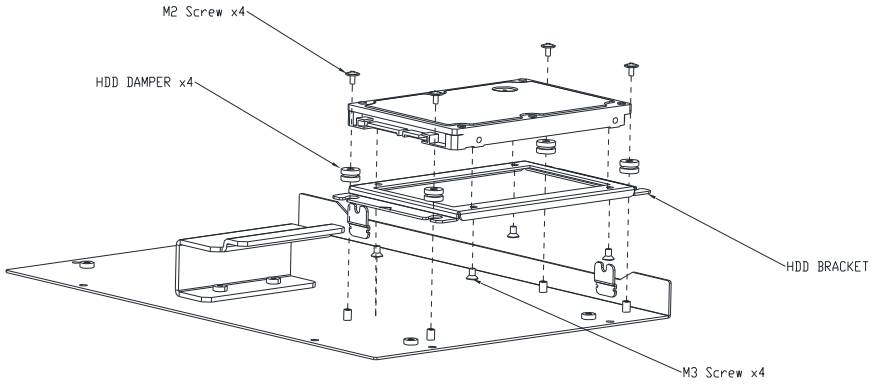

Step 2: Attach the HDD Bracket to the bottom panel using four screws as shown in the figure above. Attach the SATA and SATA Power cables to the board and the SATA drive.

2.7 M.2 Expansion Module Installation

Follow standard procedures for expansion card installation, aligning the notch on each M.2 SSD with its respective key slot, as shown below.

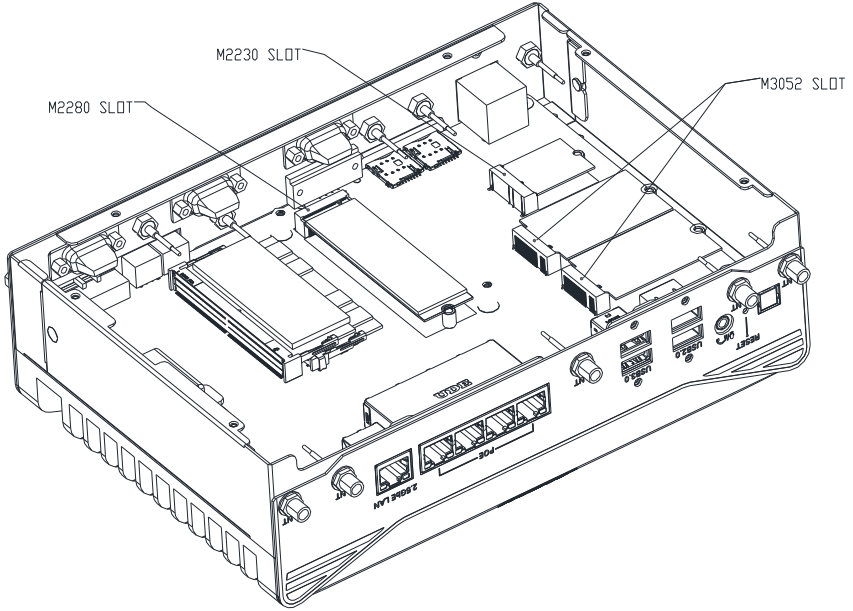

Note: When populating the M.2 2280 M-Key slot, ensure the appropriate thermal pad and heatsink are used, as shown below.

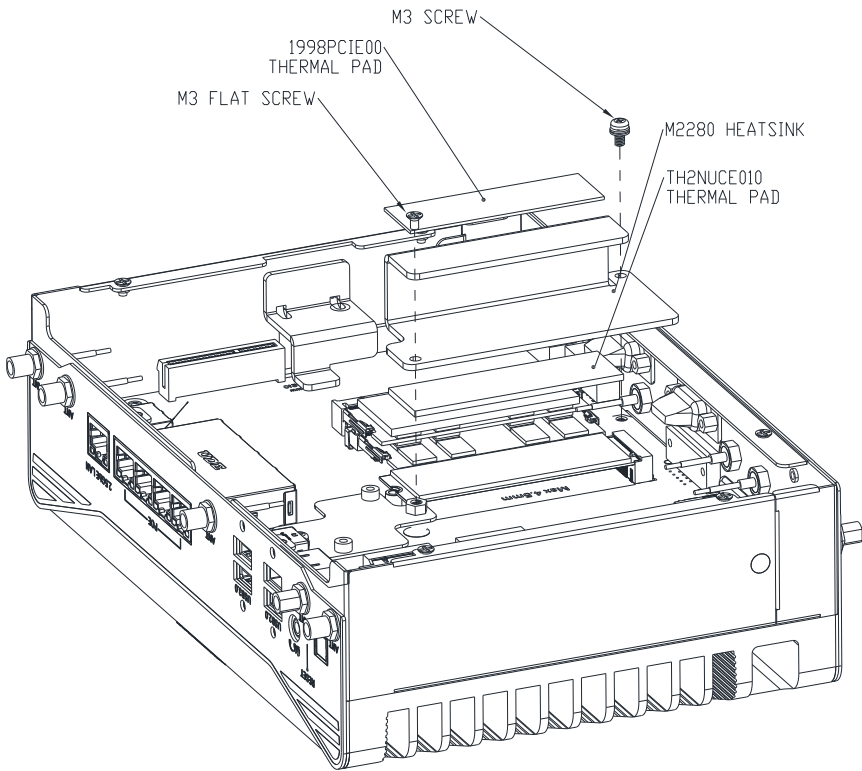

Chapter 3

AMI BIOS Setup

3.1 System Test and Initialization

The system uses certain routines to perform testing and initialization during the boot up sequence. If an error, fatal or non-fatal, is encountered, the system will output a few short beeps or display an error message. The system can usually continue the boot up sequence with non-fatal errors.

System verification routines check the current system configuration stored in the CMOS memory and BIOS NVRAM. If the system configuration is not found or a system configuration data error is detected, the system will load the Optimized Default Settings and re-boot with this configuration automatically.

There are four situations in which the CMOS settings will need to be setup or changed:

- Starting the system for the first time
- The system hardware has been changed
- The system configuration was reset by the Clear CMOS jumper.
- The CMOS memory has lost power and the configuration information is erased

The system's CMOS memory uses a backup battery for data retention. The battery must be replaced when it runs down.

3.2 AMI BIOS Setup

The AMI BIOS ROM has a pre-installed Setup program that allows users to modify basic system configurations, which is stored in the battery-backed CMOS RAM and BIOS NVRAM so that the information is retained when the power is turned off.

To enter BIOS Setup, power on the system and immediately press or <Esc>.

The function for each interface can be found below.

Main – Date and time can be set here. Press <Tab> to switch between date elements

Advanced – Enable/ Disable boot option for legacy network devices

System I/O – Enable/ Disable system I/O device

Boot – Enable/ Disable quiet Boot Option

Security – The setup administrator password can be set here

Save & Exit – Save your changes and exit the program

MEBx – Intel® Management Engine BIOS Extension

3.3 Setup Submenu: Main



3.4 Setup Submenu: Advanced



3.4.1 CPU Configuration

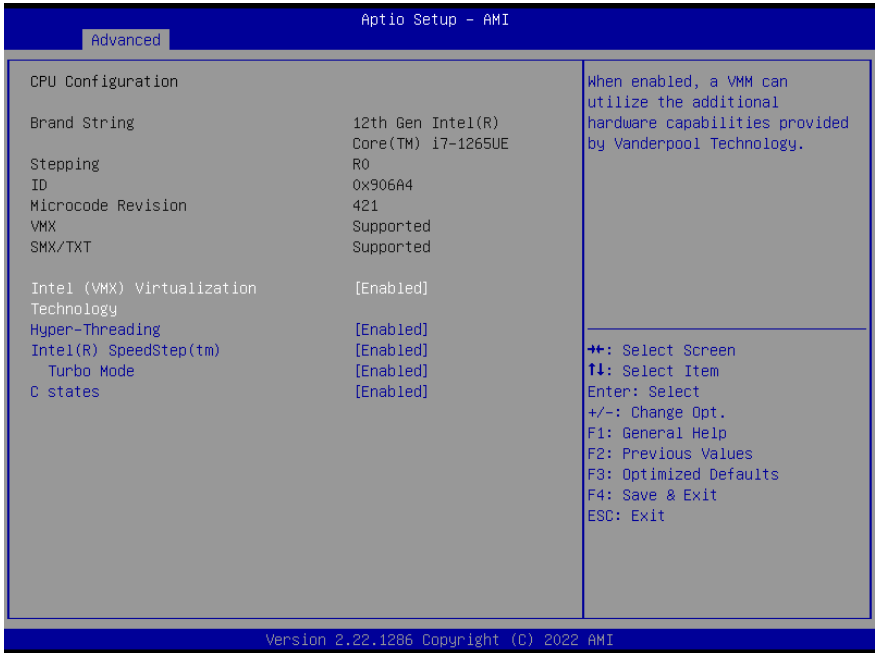

Options Summary		
Intel (VMX) Virtualization Technology	Disabled	
	Enabled	Optimal Default, Failsafe Default
When enabled, a VMM can utilize the additional hardware capabilities provided by Vanderpool Technology.		
Hyper-Threading	Disabled	
	Enabled	Optimal Default, Failsafe Default
Enable or Disable Hyper-Threading Technology		
Intel® SpeedStep™	Disabled	
	Enabled	Optimal Default, Failsafe Default
Allows more than two frequency ranges to be supported		
Turbo Mode	Disabled	
	Enabled	Optimal Default, Failsafe Default
Enable/Disable processor Turbo Mode (requires EMTTM enabled too).		
AUTO means enabled.		

Options Summary		
C states	Disabled	
	Enabled	Optimal Default, Failsafe Default
Enable/Disable CPU Power Management. Allows CPU to go to C states when it's not 100% utilized.		

3.4.2 Memory Configuration

Advanced
Aptio Setup - AMI

Memory Configuration

Total Memory	32768 MB
Memory Frequency	4800 MHz
tCL-tRCD-tRP-tRAS	40-39-39-77
MC 0 Ch 0 DIMM 0	Not Populated / Disabled
MC 1 Ch 0 DIMM 0	Populated & Enabled
Size	32768 MB (DDR5)

++: Select Screen
 ↑↓: Select Item
 Enter: Select
 +/-: Change Opt.
 F1: General Help
 F2: Previous Values
 F3: Optimized Defaults
 F4: Save & Exit
 ESC: Exit

Version 2.22.1286 Copyright (C) 2023 AMI

3.4.3 PCH-FW Configuration

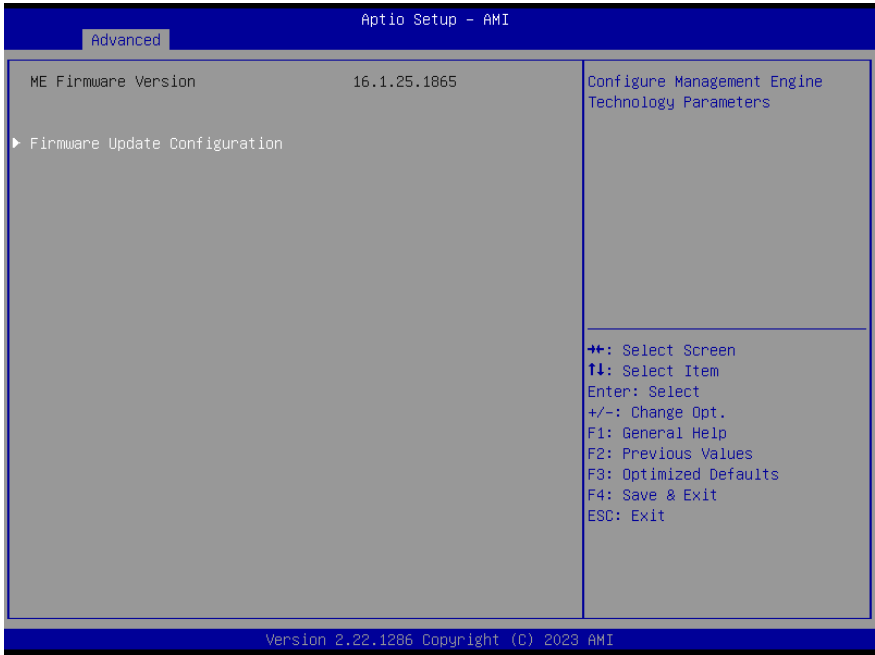

Options Summary		
AMT BIOS Features	Enabled	Optimal Default, Failsafe Default
	Disabled	
<p>When disabled AMT BIOS Features are no longer supported and user is no longer able to access MEBx Setup.</p> <p>Note: This option does not disable Manageability Features in FW.</p>		

3.4.3.1 Firmware Update Configuration

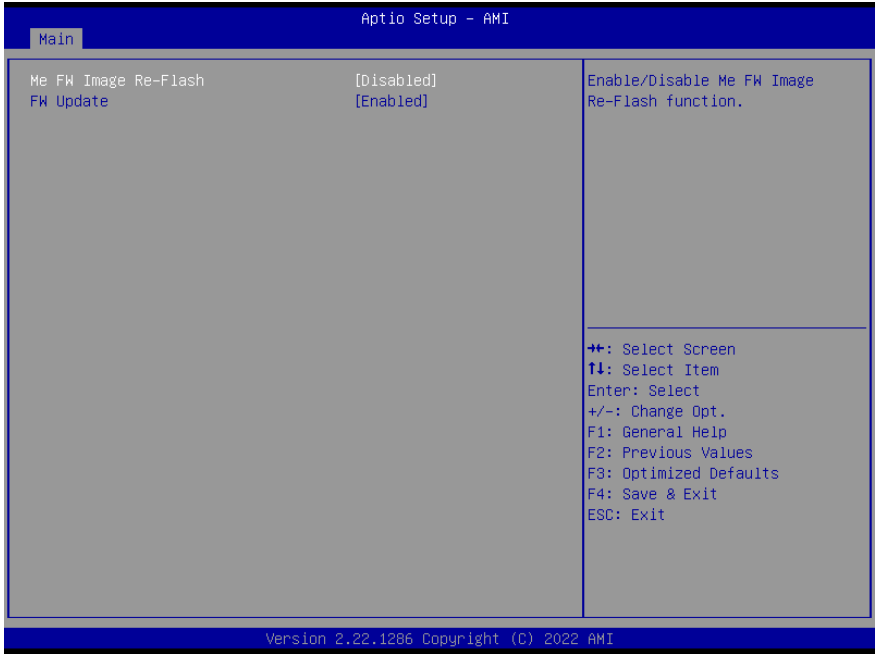

Options Summary		
Me FW Image Re-Flash	Enabled	
	Disabled	Optimal Default, Failsafe Default
Enabled/ Disable Me FW Image Re-Flash function.		
FW Update	Enabled	
	Disabled	Optimal Default, Failsafe Default
Enabled/ Disable Me FW Update function.		

3.4.4 Hardware Monitor

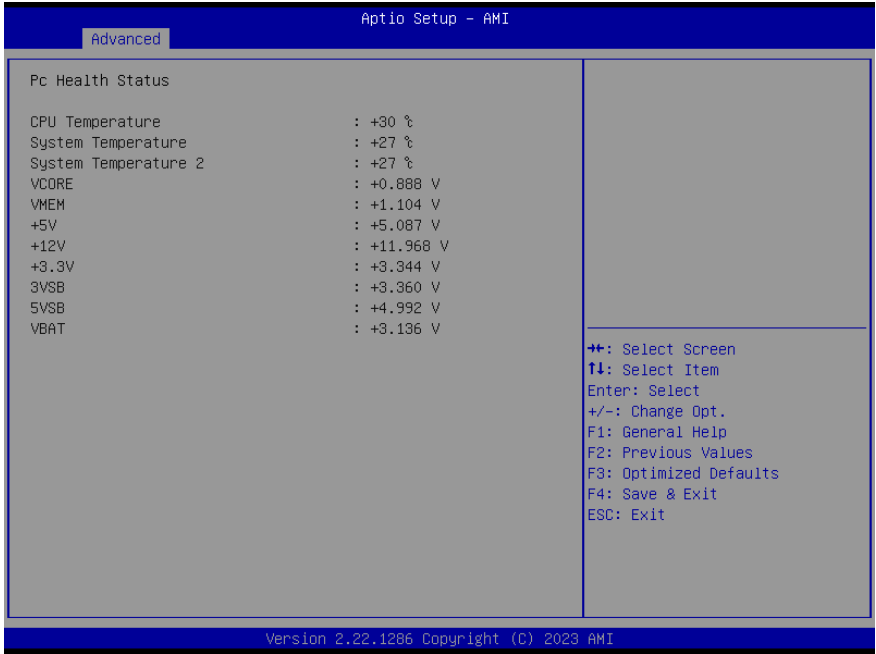

3.4.5 Power Management

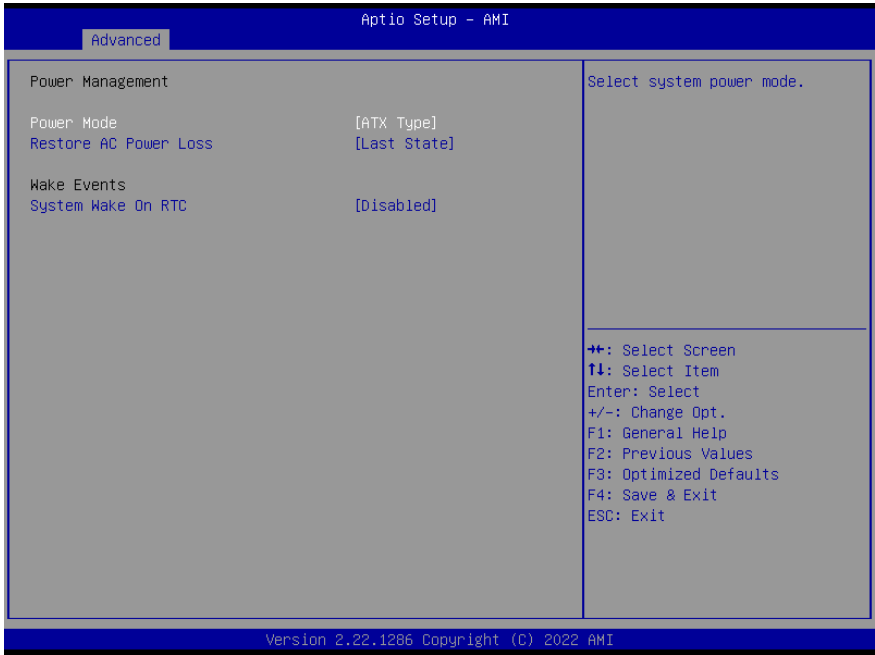

Options Summary		
Power Mode	ATX Type	Optimal Default, Failsafe Default
	AT Type	
Select system power mode.		
Restore AC Power Loss	Last State	Optimal Default, Failsafe Default
	Always On	
	Always Off	
Set GPI[3:0] Output as Hi or Low.		
System Wake On RTC	Disabled	Optimal Default, Failsafe Default
	By Date	
	By Weekday	
	Bypass	
By Date: System will wake on the day with hr::min::sec specified.		
By Weekday: System will wake on the enabled weekday with hr::min::sec specified.		
Bypass: BIOS will not control RTC wake function.		

3.4.6 AAEON BIOS Robot

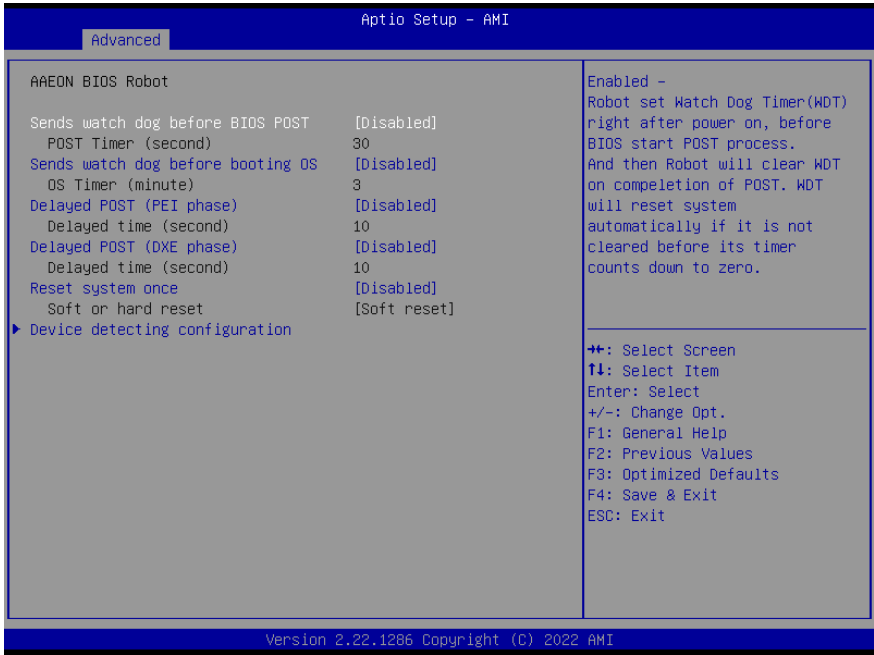

Options Summary		
Sends watch dog before BIOS POST	Disabled	Optimal Default, Failsafe Default
	Enabled	
<p>Enabled – Robot set Watch Dog Timer (WDT) right after power on, before BIOS start POST process. And then Robot will clear WDT on completion of POST. WDT on completion of POST. WDT. WDT will reset system automatically if it is not cleared before its timer counts down to zero.</p>		
Sends watch dog before booting OS	Disabled	Optimal Default, Failsafe Default
	Enabled	
<p>Enabled – Robot set Watch Dog Timer (WDT) after POST completion, before BIOS transfer control to OS. WARNING: Before enabling this function, a program in OS must be in responsible for clearing WDT. Also, this function should be disabled if OS I going to update itself.</p>		

Options Summary		
Delayed POST (PEI phase)	Disabled	Optimal Default, Failsafe Default
	Enabled	
Enabled -Robot holds BIOS from starting POST, right after power on. This allows BIOS POST to start with stable power or start after system is physically warmed-up. Note: Robot does this before 'Sends watch dog'.		
Delayed POST (DXE phase)	Disabled	Optimal Default, Failsafe Default
	Enabled	
Enabled -Robot holds BIOS before POST completion. This allows BIOS POST to start with stable power or start after system is physically warmed-up. Note: Robot does this after 'Sends watch dog before BIOS POST'.		

3.4.6.1 Device Detecting Configuration

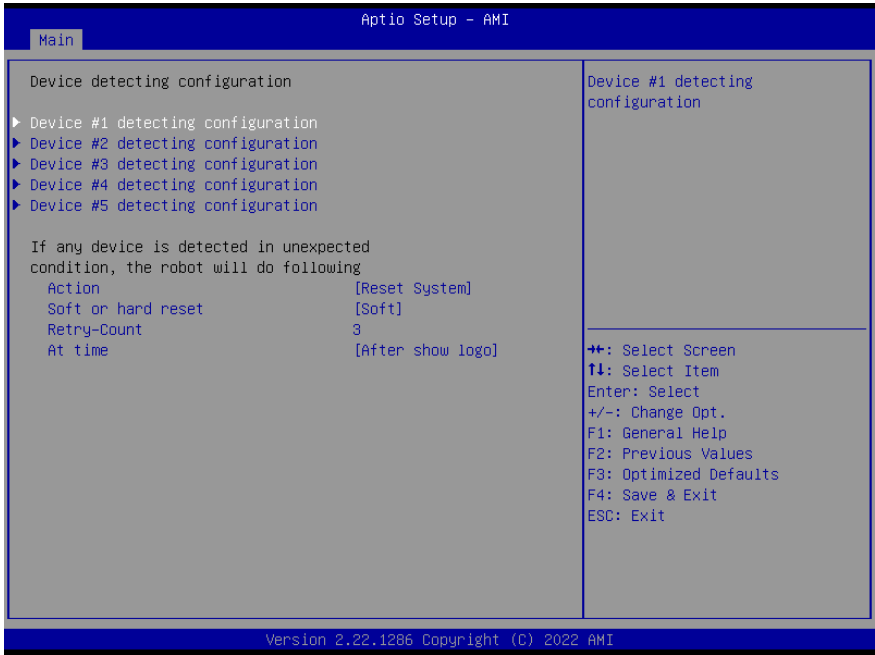

Options Summary		
Action	Reset System	Optimal Default, Failsafe Default
	Hold System	
Select action that robot should do.		
Soft or hard reset	Soft	Optimal Default, Failsafe Default
	Hard	
Select reset type robot should send on each boot.		
Retry-Count	3	Optimal Default, Failsafe Default
Fill retry counter here. Robot will reset system at most counter times, and then let system continue its POST.		
At time	After shoe logo	Optimal Default, Failsafe Default
	Before show logo	
Select robot action time: After show logo - Robot will do action after logo is displayed. System devices are almost ready. Before show logo - Robot will do action earlier before logo, but some devices may not be ready.		

3.4.6.1.1 Device #1 Detecting Configuration

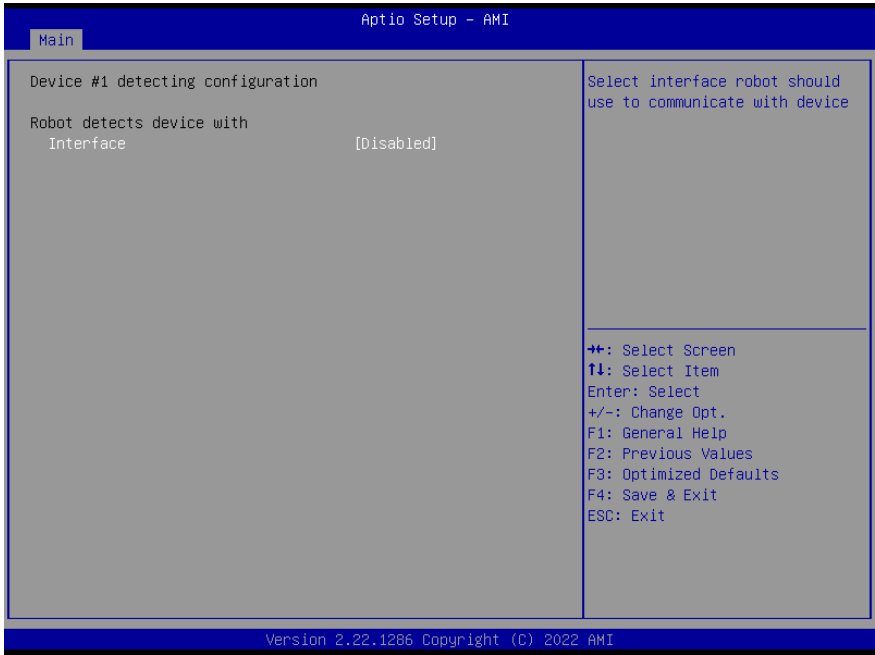

Options Summary		
Interface	Disabled	Optimal Default, Failsafe Default
	PCI	
	DIO	
	SMBUS	
	Legacy I/O	
	Super I/O	
	MMIO	
Select interface robot should use to communicate with device.		

3.4.6.1.2 Device #2 Detecting Configuration

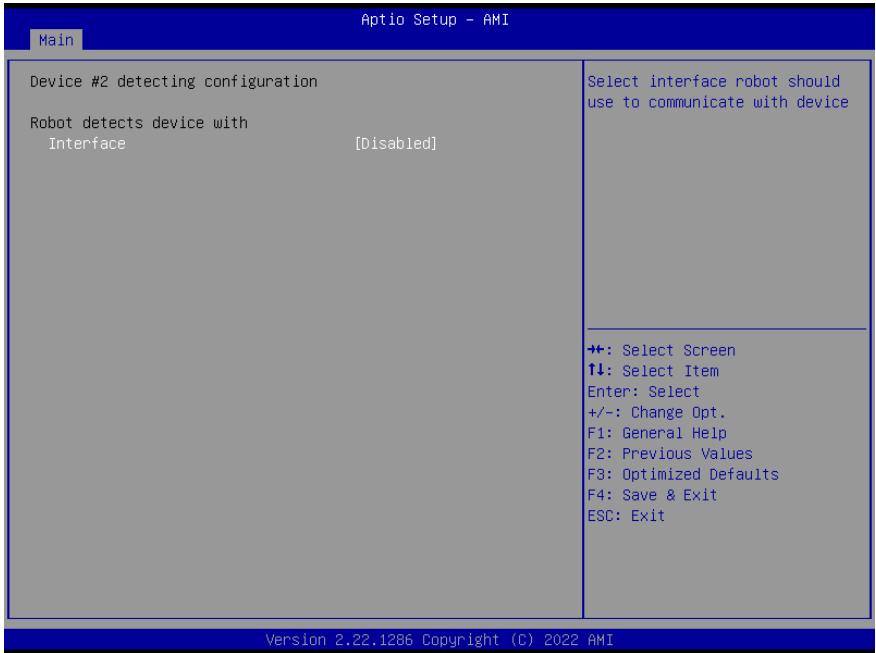

Options Summary		
Interface	Disabled	Optimal Default, Failsafe Default
	PCI	
	DIO	
	SMBUS	
	Legacy I/O	
	Super I/O	
	MMIO	
Select interface robot should use to communicate with device.		

3.4.6.1.3 Device #3 Detecting Configuration

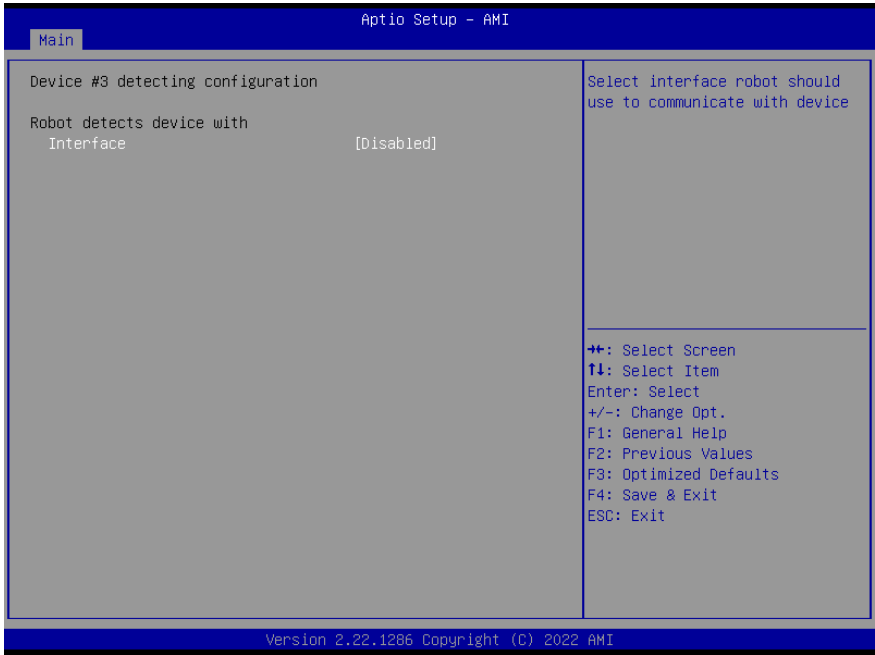

Options Summary		
Interface	Disabled	Optimal Default, Failsafe Default
	PCI	
	DIO	
	SMBUS	
	Legacy I/O	
	Super I/O	
	MMIO	
Select interface robot should use to communicate with device.		

3.4.6.1.4 Device #4 Detecting Configuration

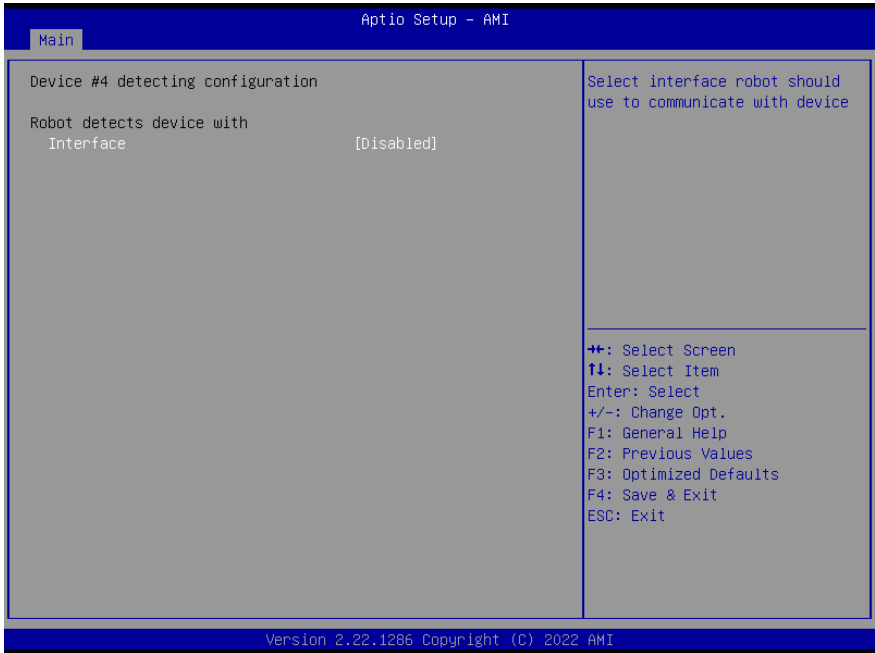

Options Summary		
Interface	Disabled	Optimal Default, Failsafe Default
	PCI	
	DIO	
	SMBUS	
	Legacy I/O	
	Super I/O	
	MMIO	
Select interface robot should use to communicate with device.		

3.4.6.1.5 Device #5 Detecting Configuration

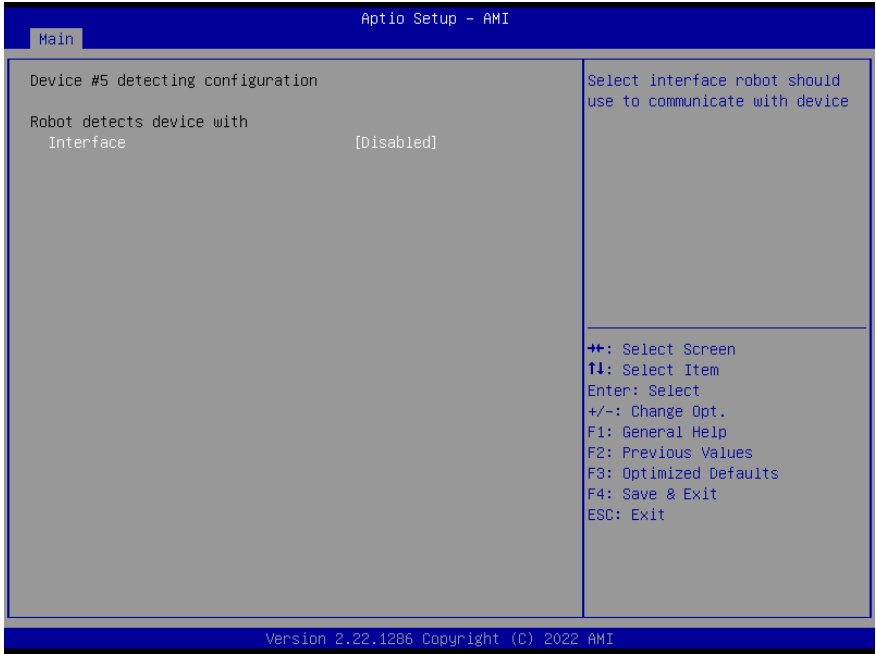

Options Summary		
Interface	Disabled	Optimal Default, Failsafe Default
	PCI	
	DIO	
	SMBUS	
	Legacy I/O	
	Super I/O	
	MMIO	
Select interface robot should use to communicate with device.		

3.5 Setup Submenu: System I/O

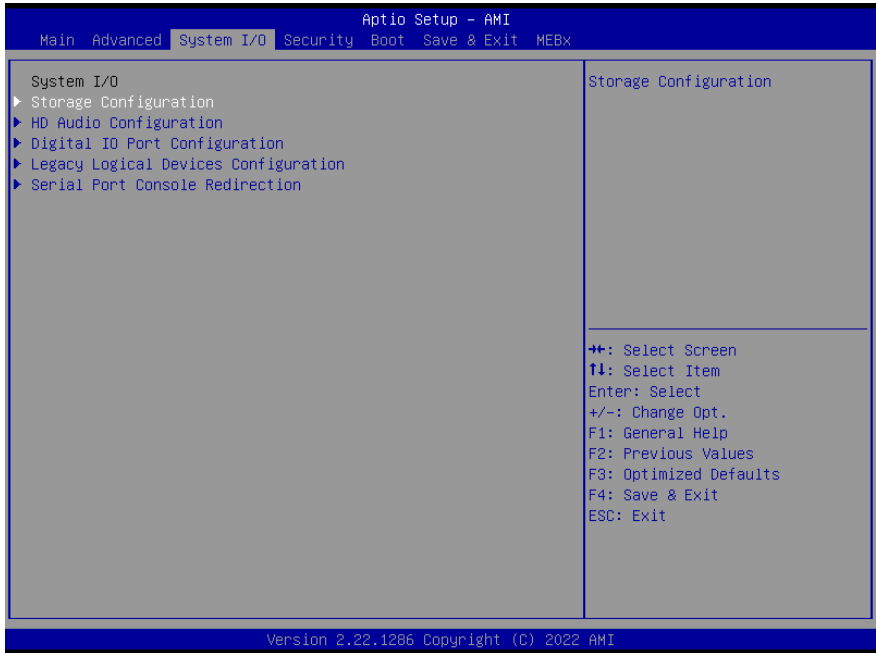

3.5.1 Storage Configuration

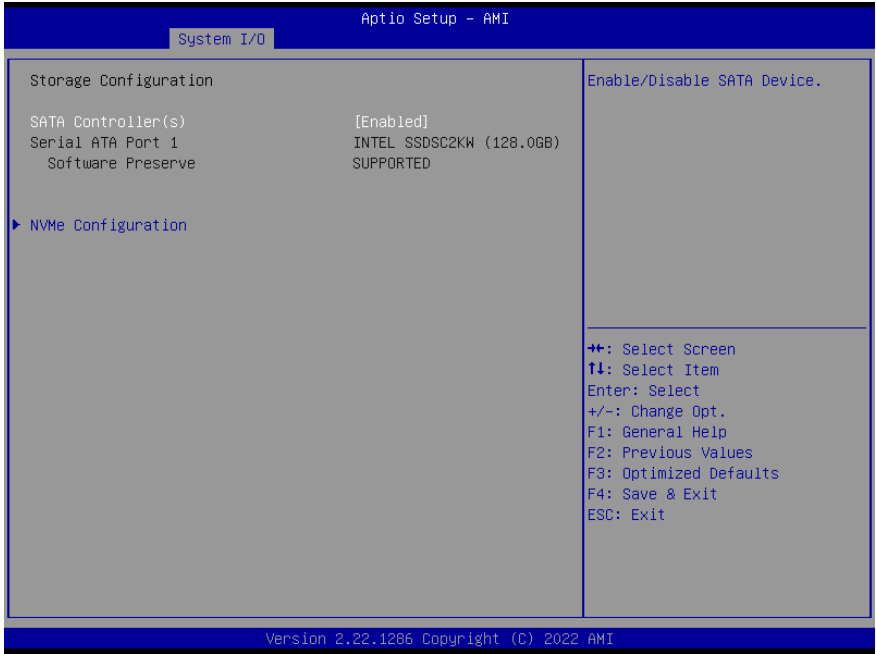

Options Summary		
SATA Controller(s)	Enabled	Optimal Default, Failsafe Default
	Disabled	
Enable/Disable to SATA Device.		

3.5.2 HD Audio Configuration

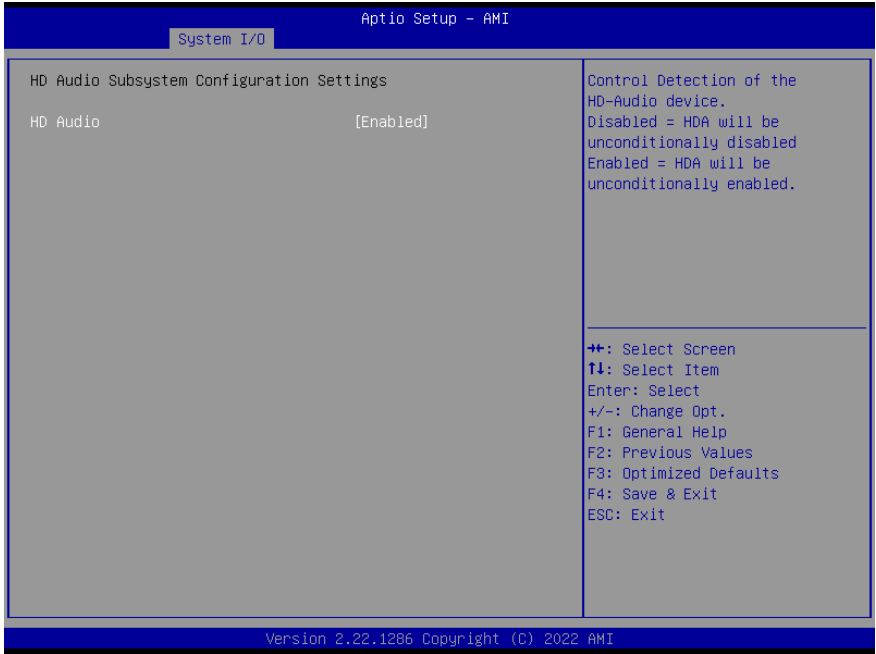

Options Summary		
HD Audio	Disabled	
	Enabled	Optimal Default, Failsafe Default
Control Detection of the HD-Audio device. Disabled = HDA will be unconditionally disabled. Enabled = HDA will be unconditionally enabled.		

3.5.3 Digital IO Port Configuration

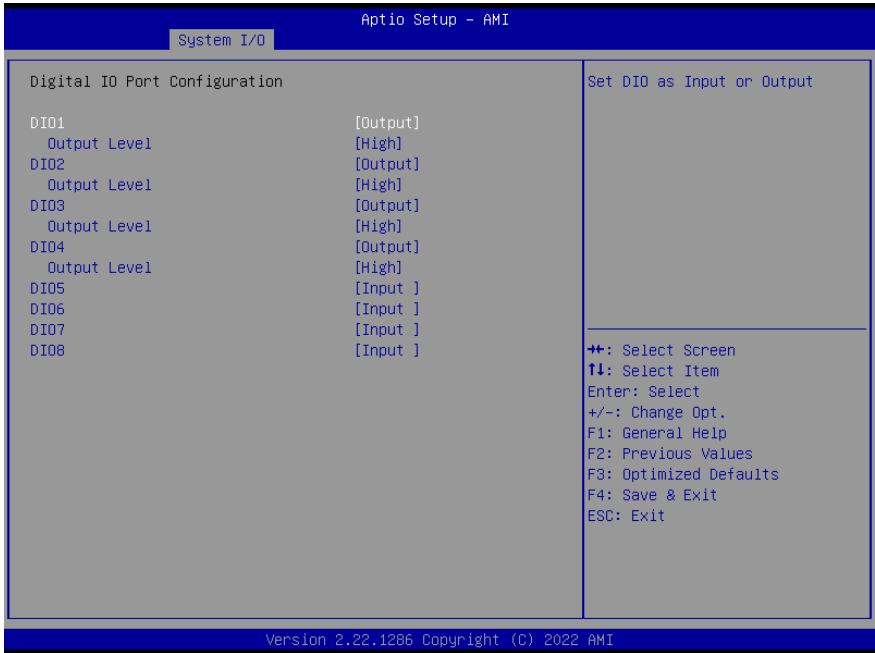

Options Summary		
DIO1	Input	
	Output	Optimal Default, Failsafe Default
Set DIO as Input or Output.		
Output Level	Low	
	High	Optimal Default, Failsafe Default
Set output level when DIO pin is output.		
DIO2	Input	
	Output	Optimal Default, Failsafe Default
Set DIO as Input or Output.		
Output Level	Low	
	High	Optimal Default, Failsafe Default
Set output level when DIO pin is output.		
DIO3	Input	
	Output	Optimal Default, Failsafe Default
Set DIO as Input or Output.		

Options Summary		
Output Level	Low	
	High	Optimal Default, Failsafe Default
Set output level when DIO pin is output.		
DIO4	Input	
	Output	Optimal Default, Failsafe Default
Set DIO as Input or Output.		
Output Level	Low	
	High	Optimal Default, Failsafe Default
Set output level when DIO pin is output.		
DIO5	Input	Optimal Default, Failsafe Default
	Output	
Set DIO as Input or Output.		
DIO6	Input	Optimal Default, Failsafe Default
	Output	
Set DIO as Input or Output.		
DIO7	Input	Optimal Default, Failsafe Default
	Output	
Set DIO as Input or Output.		
DIO8	Input	Optimal Default, Failsafe Default
	Output	
Set DIO as Input or Output.		

3.5.4 Legacy Logical Devices Configuration

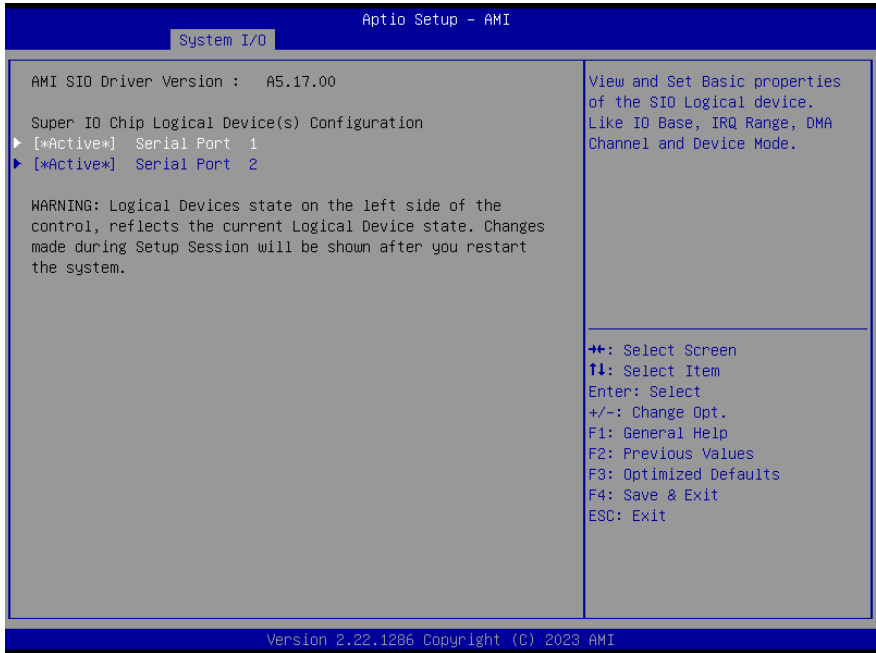

3.5.4.1 Serial Port 1

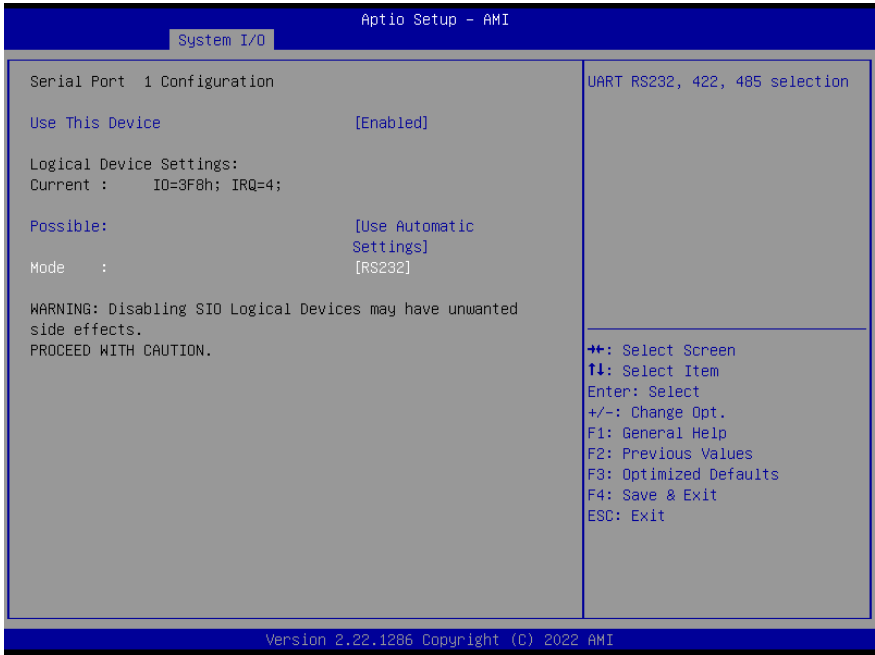

Options Summary		
Use This Device	Disabled	
	Enabled	Optimal Default, Failsafe Default
Enable or Disable this Logical Device.		
Possible:	Use Automatic Settings	Optimal Default, Failsafe Default
	IO=3F8; IRQ=4;	
	IO=2F8; IRQ=3;	
Allows the user to change the device resource settings. New settings will be reflected on this setup page after system restarts.		
Mode	RS232	Optimal Default, Failsafe Default
	RS422	
	RS485	
UART RS232, 422, 485, selection.		

3.5.4.2 Serial Port 2

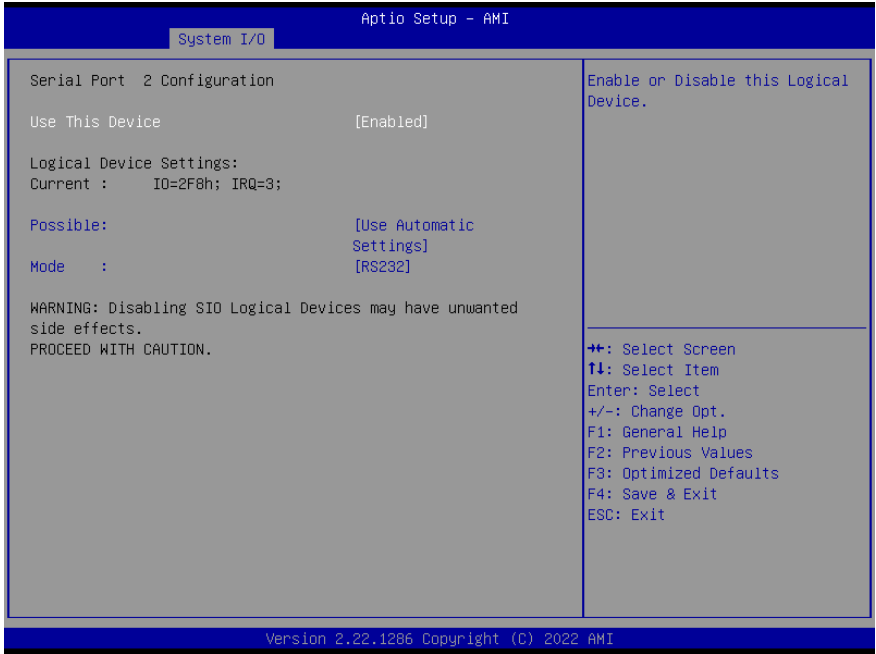

Options Summary		
Use This Device	Disabled	
	Enabled	Optimal Default, Failsafe Default
Enable or Disable this Logical Device.		
Possible:	Use Automatic Settings	Optimal Default, Failsafe Default
	IO=2F8; IRQ=3;	
	IO=3F8; IRQ=4;	
Allows the user to change the device resource settings. New settings will be reflected on this setup page after system restarts.		
Mode	RS232	Optimal Default, Failsafe Default
	RS422	
	RS485	
UART RS232, 422, 485, selection.		

3.5.5 Serial Port Console Redirection

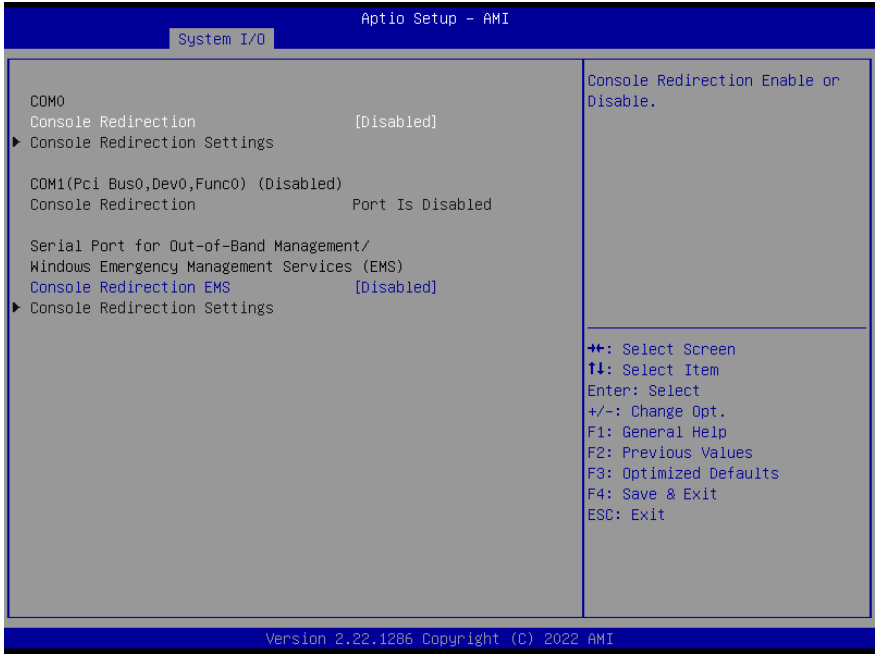

Options Summary		
Console Redirection	Disabled	Optimal Default, Failsafe Default
	Enabled	
Console Redirection Enable or Disable.		
Console Redirection EMS	Disabled	Optimal Default, Failsafe Default
	Enabled	
Console Redirection Enable or Disable.		

3.5.5.1 Console Redirection Settings (COM0)

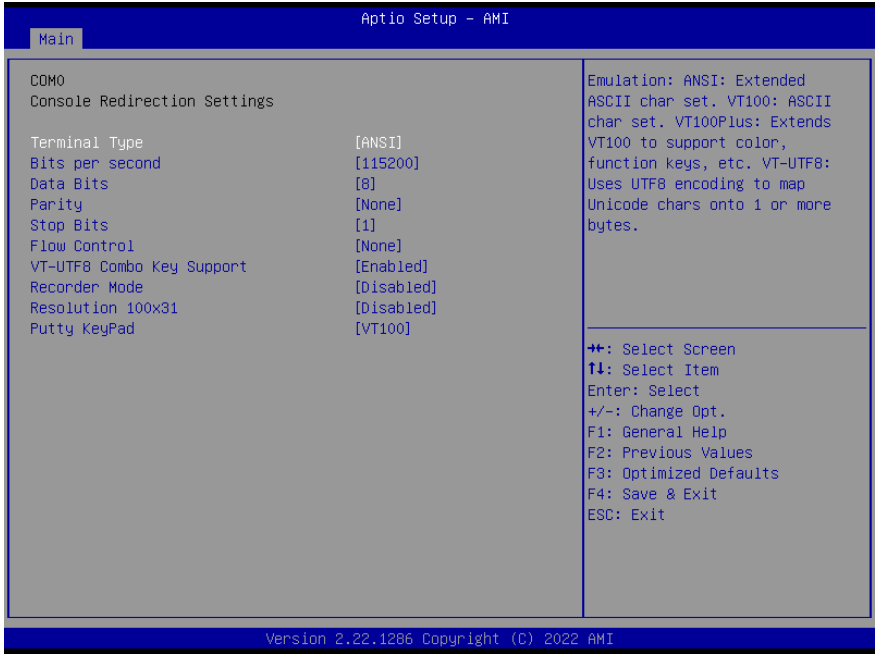

Options Summary		
Terminal Type	VT100	
	VT100Plus	
	VT-UTF8	
	ANSI	Optimal Default, Failsafe Default
Emulation: ANSI: Extended ASCII char set. VT100: ASCII char set. VT100Plus: Extends VT100 to support color, function keys, etc. VT-UTF8: Uses UTF8 encoding to map Unicode chars onto 1 or more bytes.		
Bits per second	9600	
	19200	
	38400	
	57600	
	115200	Optimal Default, Failsafe Default

Options Summary

Selects serial port transmission speed.

The speed must be matched on the other side. Long or noisy lines may require lower speeds.

Data Bits	7	
	8	Optimal Default, Failsafe Default

Data Bits.

Parity	None	Optimal Default, Failsafe Default
	Even	
	Odd	
	Mark	
	Space	

A parity bit can be sent with the data bits to detect some transmission errors.

Even: parity bit is 0 if the num of 1's in the data bits is even.

Odd: parity bit is 0 if num of 1's in the data bits is odd.

Mark: parity bit is always 1.

Space: Parity bit is always 0.

Mark and Space Parity do not allow for error detection. They can be used as an additional data bit.

Stop Bits	1	Optimal Default, Failsafe Default
	2	

Stop bits indicate the end of a serial data packet. (A start bit indicates the beginning). The standard setting is 1 stop bit. Communication with slow devices may require more than 1 stop bit.

Flow Control	None	Optimal Default, Failsafe Default
	Hardware RTS/CTS	

Flow control can prevent data loss from buffer overflow. When sending data, if the receiving buffers are full, a 'stop' signal can be sent to stop the data flow. Once the buffers are empty, a 'start' signal can be sent to re-start the flow. Hardware flow control uses two wires to send start/stop signals.

VT-UTF8 Combo Key Support	Disabled	
	Enabled	Optimal Default, Failsafe Default

Enable VT-UTF8 Combination Key Support for ANSI/VT100 terminals

Recorder Mode	Disabled	Optimal Default, Failsafe Default
	Enabled	

With this mode enabled only text will be sent. This is to capture Terminal data.

Options Summary		
Resolution 100x31	Disabled	Optimal Default, Failsafe Default
	Enabled	
Enables or disables extended terminal resolution		
Putty KeyPad	VT100	Optimal Default, Failsafe Default
	LINUX	
	XTERMR6	
	SCO	
	ESCN	
	VT400	
Select FunctionKey and KeyPad on Putty.		

3.5.5.2 Console Redirection Settings (Out-of-Band Mgmt)

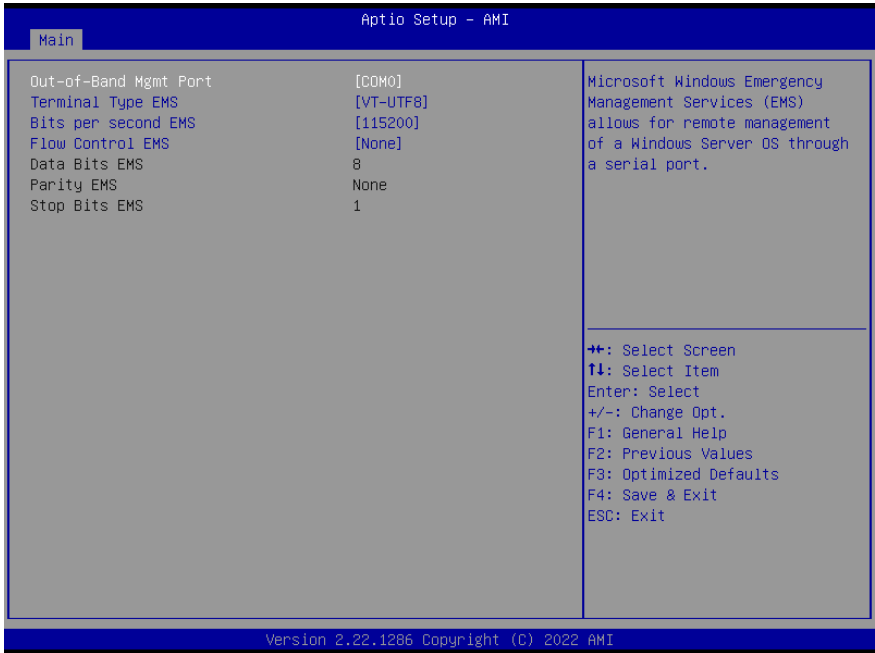

Options Summary		
Out-of-Band Mgmt Port	COM0	Optimal Default, Failsafe Default
	COM1(Pci Bus0, Dev0, Func0) (Disabled)	
Microsoft Windows Emergency Management Services (EMS) allows for remote management of a Windows Server OS through a serial port.		
Terminal Type EMS	VT100	
	VT100Plus	
	VT-UTF8	Optimal Default, Failsafe Default
	ANSI	
VT-UTF8 is the preferred terminal type for out-of-band management.		
The next best choice is VT100+ and then VT100.		
See above, in Console Redirection Settings page, for more Help with Terminal Type/Emulation.		

Options Summary		
Bits per second EMS	9600	
	19200	
	57600	
	115200	Optimal Default, Failsafe Default
Selects serial port transmission speed. The speed must be matched on the other side. Long or noisy lines may require lower speeds.		
Flow Control EMS	None	Optimal Default, Failsafe Default
	Hardware RTS/CTS	
	Software Xon/Xoff	
Flow control can prevent data loss from buffer overflow. When sending data, if the receiving buffers are full, a 'stop' signal can be sent to stop the data flow. Once the buffers are empty, a 'start' signal can be sent to re-start the flow. Hardware flow control uses two wires to send start/stop signals.		

3.6 Setup Submenu: Security

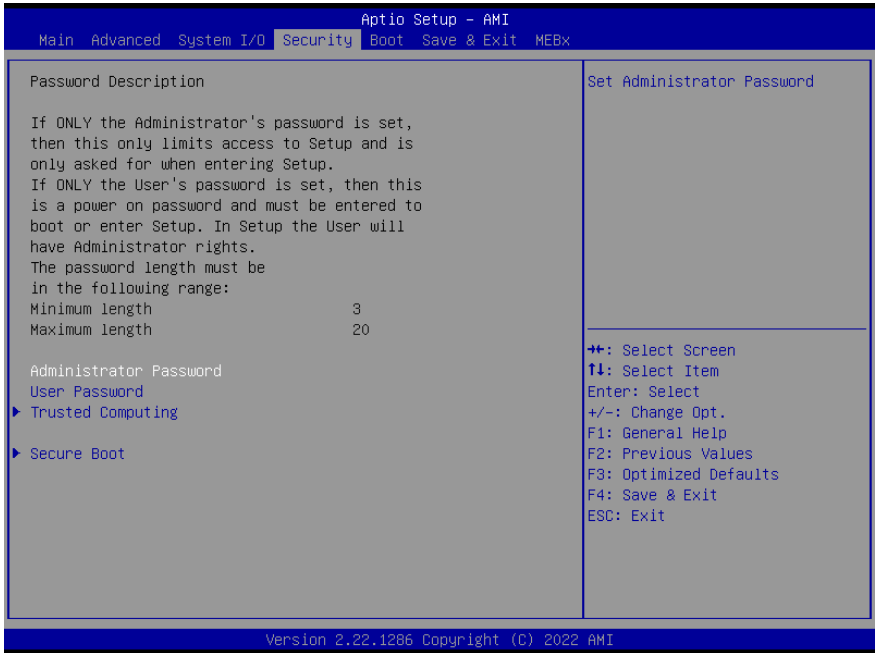

Change User/Administrator Password

You can set an Administrator Password or User Password. An Administrator Password must be set before you can set a User Password. The password will be required during boot up, or when the user enters the Setup utility. A User Password does not provide access to many of the features in the Setup utility.

Select the password you wish to set, and press Enter. In the dialog box, enter your password (must be between 3 and 20 letters or numbers). Press Enter and retype your password to confirm. Press Enter again to set the password.

Removing the Password

Select the password you want to remove and enter the current password. At the next dialog box press Enter to disable password protection.

3.6.1 Trusted Computing

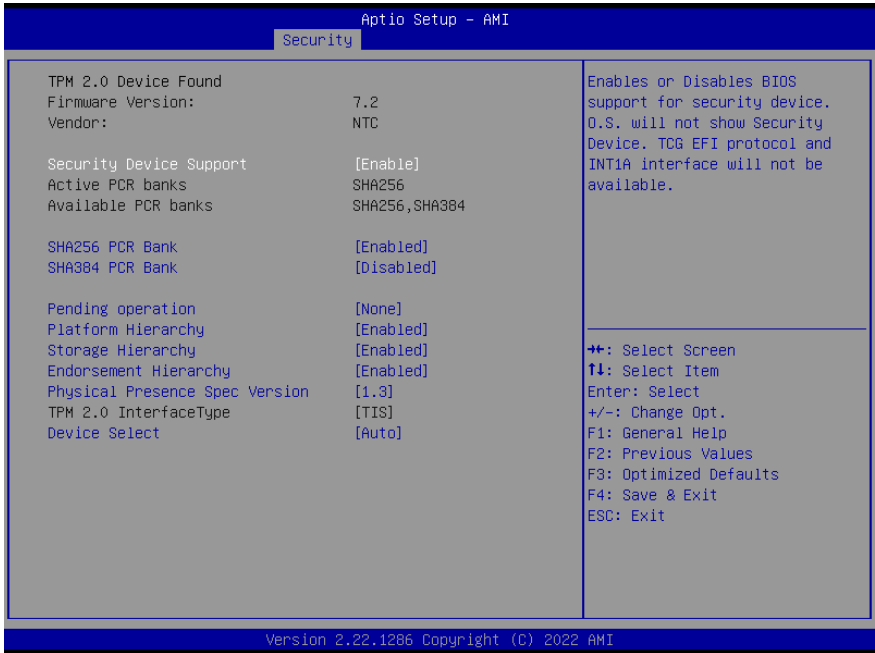

Options Summary		
Security Device Support	Enable	Optimal Default, Failsafe Default
	Disable	
Enables or Disables BIOS support for security device. O.S. will not show Security Device. TCG EFI protocol and INT1A interface will not be available.		
SHA256 PCR Bank	Disabled	
	Enabled	Optimal Default, Failsafe Default
Enable or Disable SHA256 PCR Bank.		
SHA384 PCR Bank	Disabled	Optimal Default, Failsafe Default
	Enabled	
Enable or Disable SHA384 PCR Bank.		
Pending operation	None	Optimal Default, Failsafe Default
	TPM Clear	
Schedule an Operation for the Security Device.		
NOTE: Your Computer will reboot during restart in order to change State of Security Device.		

Options Summary		
Platform Hierarchy	Disabled	
	Enabled	Optimal Default, Failsafe Default
Enable or Disable Platform Hierarchy.		
Storage Hierarchy	Disabled	
	Enabled	Optimal Default, Failsafe Default
Enable or Disable Storage Hierarchy.		
Endorsement Hierarchy	Disabled	
	Enabled	Optimal Default, Failsafe Default
Enable or Disable Endorsement Hierarchy.		
Physical Presence Spec Version	1.2	
	1.3	Optimal Default, Failsafe Default
Select to Tell O.S. to support PPI Spec Version 1.2 or 1.3. Note some HCK tests might not support 1.3.		
Device Select	TPM 1.2	
	TPM 2.0	
	Auto	Optimal Default, Failsafe Default
TPM 1.2 will restrict support to TPM 1.2 devices. TPM 2.0 will restrict support to TPM 2.0 devices. Auto will support both with the default set to TPM 2.0 devices if not found. TPM 1.2 devices will be enumerated.		

3.6.2 Secure Boot

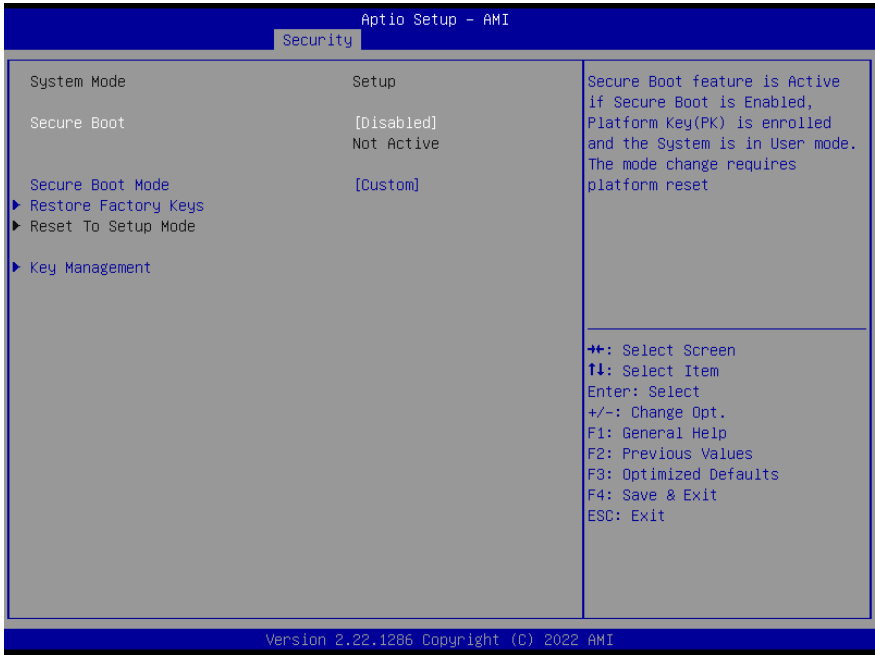

Options Summary		
Secure Boot	Disabled	Optimal Default, Failsafe Default
	Enabled	
Secure Boot feature is Active if Secure Boot is Enabled, Platform Key (PK) is enrolled and the System is in User mode. The mode change requires platform reset.		
Secure Boot Mode	Standard	
	Custom	Optimal Default, Failsafe Default
Secure Boot mode options: Standard or Custom. In Custom mode, Secure Boot Policy variables can be configured by a physically present user without full authentication.		
Restore Factory Keys	Yes	
	No	
Force System to User Mode. Install factory default Secure Boot key databases.		

3.6.2.1 Key Management

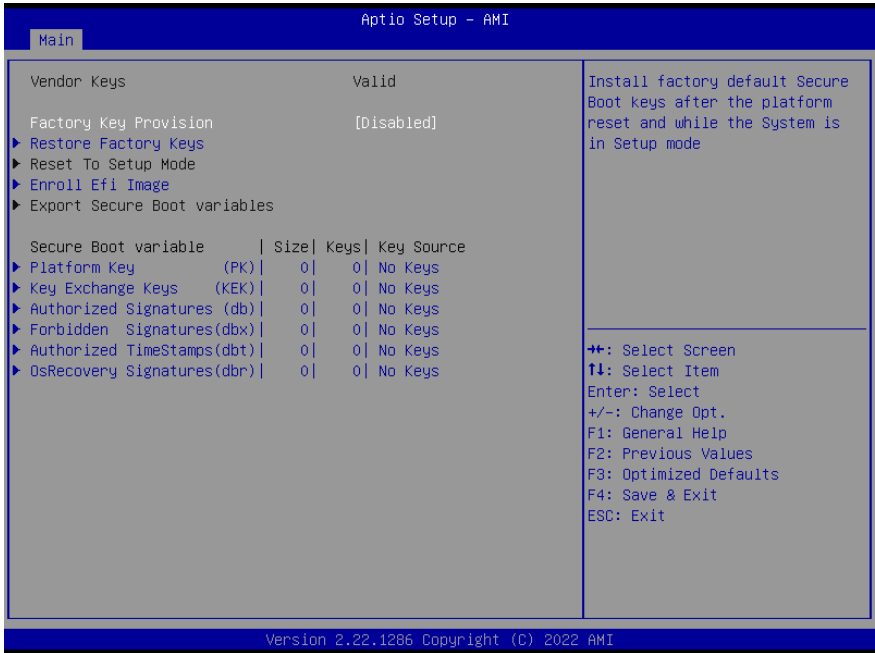

Options Summary		
Factory Key Provision	Disabled	Optimal Default, Failsafe Default
	Enabled	
Install factory default Secure Boot keys after the platform reset and while the System is in Setup mode.		
Restore Factory Keys	Yes	
	No	
Force System to User Mode. Install factory default Secure Boot key databases.		
Enroll Efi Image		
Allow Efi image to run in Secure Boot mode. Enroll SHA256 Hash certificate of a PE image into Authorized Signature Database (db).		
Platform Key (PK)	Update	
Key Exchange Keys (KEK)	Update	
	Append	
Authorized Signatures (db)	Update	
	Append	

Options Summary		
Forbidden Signatures (dbx)	Update	
	Append	
Authorized TimeStamps (dbt)	Update	
	Append	
OsRecovery Signatures (dbr)	Update	
	Append	
<p>Enroll Factory Defaults or load certificates from a file:</p> <p>1.Public Key Certificate:</p> <ul style="list-style-type: none"> a) EFI_SIGNATURE_LIST b) EFI_CERT_X509 (DER) c) EFI_CERT_RSA2048 (bin) d) EFI_CERT_SHAXXX <p>2.Authenticated UEFI Variable</p> <p>3.EFI PE/COFF Image (SHA256)</p> <p>Key Source: Factory, External, Mixed.</p>		

3.7 Setup Submenu: Boot

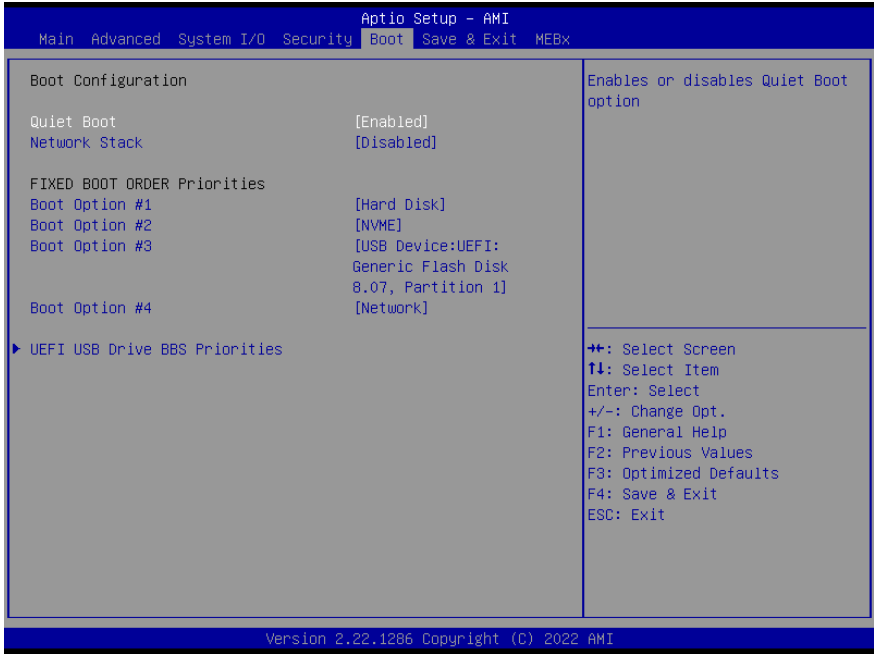

Options Summary		
Quiet Boot	Disabled	
	Enabled	Default
Enables/disables Quiet Boot option.		
Network Stack	Disabled	Default
	Enabled	
Enable/Disable UEFI Network Stack.		
Boot Option #1	Hard Disk	
Boot Option #2	NVME	
Boot Option #3	USB Device	
Boot Option #4	Network	
Sets the system boot order.		

3.7.1 UEFI BBS Priorities

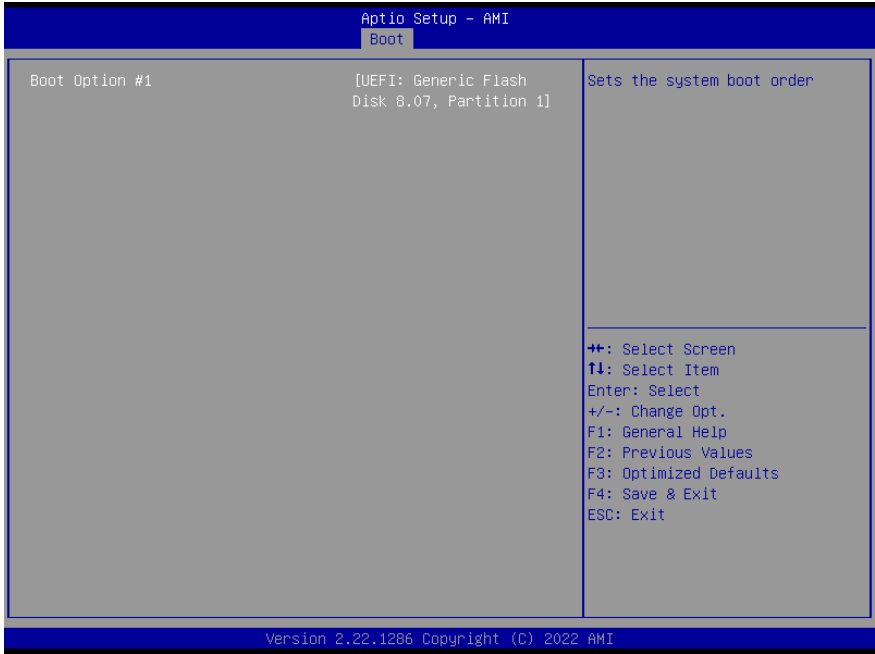

Options Summary		
Quiet Boot	Disabled	
	Enabled	Default
Enables/disables Quiet Boot option.		
Network Stack	Disabled	Default
	Enabled	
Enable/Disable UEFI Network Stack.		
Boot Option #1	Hard Disk	
Boot Option #2	NVME	
Boot Option #3	USB Device	
Boot Option #4	Network	
Sets the system boot order.		

3.8 Setup Submenu: Save & Exit

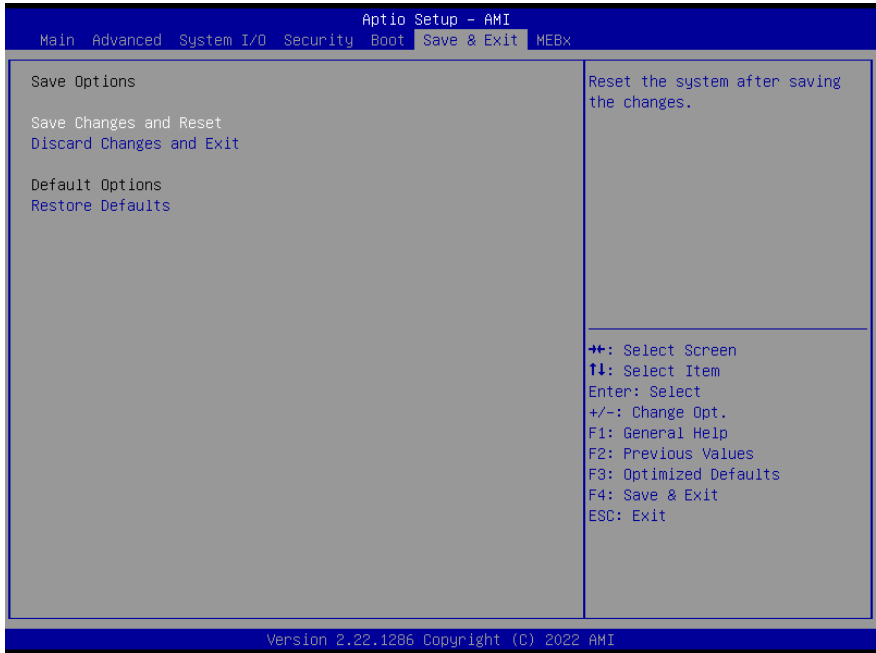

3.9 Setup Submenu: MEBx



Chapter 4

Driver Installation

4.1 Drivers Download and Installation

Drivers for the VPC-5640S can be downloaded from the product page on the AAEMON website here: <https://www.aaeon.com/en/p/smart-in-vehicle-and-amr-box-pc>

Download the driver(s) you need and follow the steps below to install them.

Install Chipset Driver

1. Open the **Chipset** folder
2. Open the **SetupChipset.exe** file in the folder
3. Follow the instructions
4. Drivers will be installed automatically

Install Serial IO Driver

1. Open the **Serial IO Driver** folder
2. Open the **SetupSerialIO.exe** file in the folder
3. Follow the instructions
4. Drivers will be installed automatically

Install Graphics Driver

1. Open the **Graphics Driver** folder
2. Open the **Installer.exe** file in the folder
3. Follow the instructions
4. Drivers will be installed automatically

Install ME & TXE Driver

1. Open the **ME & TXE Driver** folder
2. Open the **SetupME.exe** file in the folder
3. Follow the instructions
4. Drivers will be installed automatically

Install LAN Driver

1. Open the **LAN Driver** folder
2. Open the **Autorun.exe** file in the folder
3. Follow the instructions
4. Drivers will be installed automatically

Install Audio Drivers

Note: Ensure Intel Smart Sound Driver (**ADSP-10.29.00.8467**) is installed before the Realtek Audio driver (**Realtek Audio 6.0.9239.1**)

a. Install Intel Smart Sound Driver

1. Open the **Audio (ADSP-10.29.00.8467)** folder
2. Follow the setup information within the file to manually install driver.

b. Install Realtek Audio Driver

1. Open the Realtek Audio Driver (**Realtek Audio 6.0.9239.1**) folder
2. Run the **Setup.exe** file in the folder
3. Follow the instructions
4. Driver will be installed automatically

Install Sensor Driver

1. Open the **ISH Driver** folder
2. Run the **SetupISS.exe** file in the folder
3. Follow the instructions
4. Driver will be installed automatically

Install USB to CANBus Driver

1. Open the **FUSBCAN** folder
2. Run the **Setup.exe** file in the folder
3. Follow the instructions
4. Driver will be installed automatically



Appendix A

I/O Information

A.1 I/O Address Map

Input/output (IO)	
[0000000000000000 - 000000000000CF7]	PCI Express Root Complex
[0000000000000020 - 0000000000000021]	Programmable interrupt controller
[0000000000000024 - 0000000000000025]	Programmable interrupt controller
[0000000000000028 - 0000000000000029]	Programmable interrupt controller
[000000000000002C - 000000000000002D]	Programmable interrupt controller
[000000000000002E - 000000000000002F]	Motherboard resources
[0000000000000030 - 0000000000000031]	Programmable interrupt controller
[0000000000000034 - 0000000000000035]	Programmable interrupt controller
[0000000000000038 - 0000000000000039]	Programmable interrupt controller
[000000000000003C - 000000000000003D]	Programmable interrupt controller
[0000000000000040 - 0000000000000043]	System timer
[000000000000004E - 000000000000004F]	Motherboard resources
[0000000000000050 - 0000000000000053]	System timer
[0000000000000061 - 0000000000000061]	Motherboard resources
[0000000000000063 - 0000000000000063]	Motherboard resources
[0000000000000065 - 0000000000000065]	Motherboard resources
[0000000000000067 - 0000000000000067]	Motherboard resources
[0000000000000070 - 0000000000000070]	Motherboard resources
[0000000000000080 - 0000000000000080]	Motherboard resources
[0000000000000092 - 0000000000000092]	Motherboard resources
[00000000000000A0 - 00000000000000A1]	Programmable interrupt controller
[00000000000000A4 - 00000000000000A5]	Programmable interrupt controller
[00000000000000A8 - 00000000000000A9]	Programmable interrupt controller
[00000000000000AC - 00000000000000AD]	Programmable interrupt controller
[00000000000000B0 - 00000000000000B1]	Programmable interrupt controller
[00000000000000B2 - 00000000000000B3]	Motherboard resources
[00000000000000B4 - 00000000000000B5]	Programmable interrupt controller
[00000000000000B8 - 00000000000000B9]	Programmable interrupt controller
[00000000000000BC - 00000000000000BD]	Programmable interrupt controller
[0000000000002F8 - 0000000000002FF]	Communications Port (COM2)
[00000000000003F8 - 0000000000003FF]	Communications Port (COM1)
[0000000000004D0 - 0000000000004D1]	Programmable interrupt controller
[000000000000680 - 00000000000069F]	Motherboard resources
[000000000000A00 - 000000000000A0F]	Motherboard resources
[000000000000A10 - 000000000000A1F]	Motherboard resources
[000000000000A20 - 000000000000A2F]	Motherboard resources
[000000000000D00 - 000000000000FFF]	PCI Express Root Complex
[000000000000164E - 000000000000164F]	Motherboard resources
[0000000000001854 - 0000000000001857]	Motherboard resources
[0000000000002000 - 00000000000020FE]	Motherboard resources
[0000000000003000 - 0000000000003FFF]	Intel(R) PCI Express Root Port #9 - 51B0
[0000000000004000 - 000000000000403F]	Intel(R) UHD Graphics
[0000000000004060 - 000000000000407F]	Standard SATA AHCI Controller
[0000000000004080 - 0000000000004083]	Standard SATA AHCI Controller
[0000000000004090 - 0000000000004097]	Standard SATA AHCI Controller

A.2 Memory Address Map

- ▼  Large Memory
 - [0000004000000000 - 0000007FFFFFFFFF] PCI Express Root Complex
- ▼  Memory
 - [0000000000A0000 - 0000000000BFFFFF] PCI Express Root Complex
 - [0000000080400000 - 0000000080DFFFFF] Intel(R) PCI Express Root Port #9 - 51B0
 - [0000000080400000 - 00000000BFFFFF] PCI Express Root Complex
 - [0000000080E00000 - 0000000080FFFFFF] PCI-to-PCI Bridge
 - [0000000080E00000 - 00000000811FFFFFF] Intel(R) PCI Express Root Port #12 - 51B3
 - [0000000080E00000 - 00000000811FFFFFF] PCI-to-PCI Bridge
 - [0000000080EFC000 - 0000000080EFFFFFF] Intel(R) Ethernet Controller I226-LM #4
 - [0000000080F00000 - 0000000080FFFFFF] Intel(R) Ethernet Controller I226-LM #4
 - [0000000081000000 - 00000000811FFFFFF] PCI-to-PCI Bridge
 - [00000000810FC000 - 00000000810FFFFFF] Intel(R) Ethernet Controller I226-LM #5
 - [0000000081100000 - 00000000811FFFFFF] Intel(R) Ethernet Controller I226-LM #5
 - [0000000081200000 - 00000000813FFFFFF] Intel(R) PCI Express Root Port #8 - 51BF
 - [00000000812FC000 - 00000000812FFFFFF] Intel(R) Ethernet Controller I226-LM #2
 - [0000000081300000 - 00000000813FFFFFF] Intel(R) Ethernet Controller I226-LM #2
 - [0000000081400000 - 00000000814FFFFFF] Intel(R) Ethernet Controller I226-LM #3
 - [0000000081400000 - 00000000815FFFFFF] Intel(R) PCI Express Root Port #7 - 51BE
 - [0000000081500000 - 0000000081503FFF] Intel(R) Ethernet Controller I226-LM #3
 - [0000000081600000 - 00000000816FFFFFF] Intel(R) Ethernet Controller I226-LM
 - [0000000081600000 - 00000000817FFFFFF] Intel(R) PCI Express Root Port #6 - 51BD
 - [0000000081700000 - 0000000081703FFF] Intel(R) Ethernet Controller I226-LM
 - [0000000081800000 - 0000000081801FFF] Standard SATA AHCI Controller
 - [0000000081802000 - 00000000818027FF] Standard SATA AHCI Controller
 - [0000000081803000 - 00000000818030FF] Standard SATA AHCI Controller
 - [00000000C0000000 - 00000000CFFFFFFF] Motherboard resources
 - [00000000FE010000 - 00000000FE010FFF] Intel(R) SPI (flash) Controller - 51A4
 - [00000000FE03E000 - 00000000FE03E007] Communications Port (COM3)
 - [00000000FE03E008 - 00000000FE03EFFF] Motherboard resources
 - [00000000FE03F000 - 00000000FE03FFFF] Motherboard resources
 - [00000000FED00000 - 00000000FED003FF] High precision event timer
 - [00000000FED20000 - 00000000FED7FFFF] Motherboard resources
 - [00000000FED40000 - 00000000FED44FFF] Trusted Platform Module 2.0
 - [00000000FED45000 - 00000000FED8FFFF] Motherboard resources
 - [00000000FED90000 - 00000000FED93FFF] Motherboard resources
 - [00000000FEDA0000 - 00000000FEDA0FFF] Motherboard resources
 - [00000000FEDA1000 - 00000000FEDA1FFF] Motherboard resources
 - [00000000FEDC0000 - 00000000FEDC7FFF] Motherboard resources
 - [00000000FEE00000 - 00000000FEEFFFFFFF] Motherboard resources
 - [0000004000000000 - 000000400FFFFFFF] Intel(R) UHD Graphics
 - [0000006000000000 - 0000006000FFFFFFF] Intel(R) UHD Graphics
 - [0000006001100000 - 000000600110FFFFFF] Intel(R) USB 3.10 eXtensible Host Controller - 1.20 (Microsoft)
 - [0000007FFFE90000 - 0000007FFFE99FFF] Intel(R) Management Engine Interface #1
 - [0000007FFFEA0000 - 0000007FFFEA9FFF] Intel(R) Serial IO I2C Host Controller - 51E9
 - [0000007FFFE80000 - 0000007FFFE8BFFF] Intel(R) Serial IO I2C Host Controller - 51E8
 - [0000007FFFE8C000 - 0000007FFFE8FFFF] Intel® Smart Sound Technology BUS
 - [0000007FFFE90000 - 0000007FFFE9FFFF] Intel(R) Integrated Sensor Solution
 - [0000007FFF000000 - 0000007FFF000000] Intel® Smart Sound Technology BUS

A.3 IRQ Mapping Chart

Interrupt request (IRQ)	
 (ISA) 0x00000000 (00)	System timer
 (ISA) 0x00000003 (03)	Communications Port (COM2)
 (ISA) 0x00000004 (04)	Communications Port (COM1)
 (ISA) 0x00000010 (16)	Communications Port (COM3)