

Data sheet | Item number: 899-631/327-000

Distribution box; Single-phase current (230 V); 2 inputs; 6 outputs; Cod. A;
MIDI; black

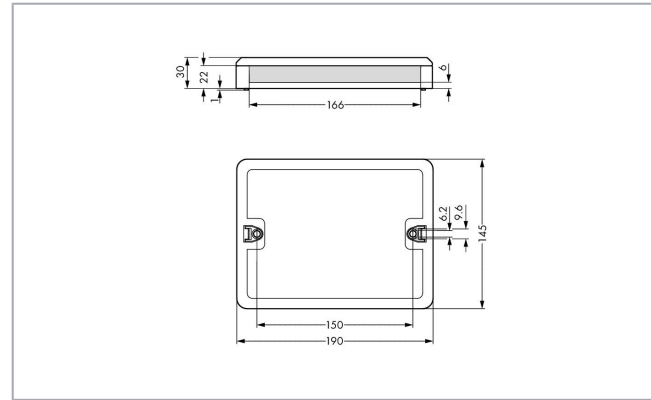

www.wago.com/899-631/327-000

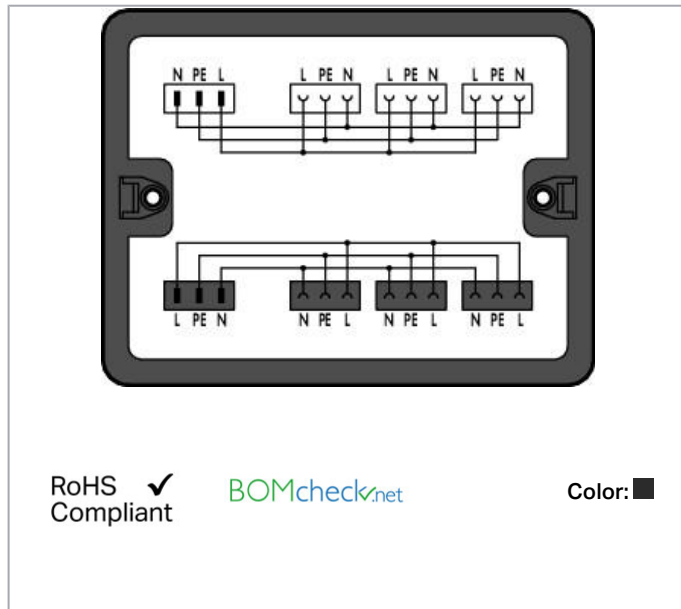

Item description

This *WINSTA*[®] Distribution Box features two 3-pole, single-phase circuits (e.g., for general power, EDP outlets and UPS systems). Three-pole connecting cables are provided for both power input and output.

Data

Electrical data

Note on contact resistance

approx. 1 mΩ of contact resistance approx. 0.25 mΩ contact transition plug/socket

Ratings per IEC/EN

Ratings per	IEC/EN 60664-1
Nominal voltage (III/3)	250 V
Rated surge voltage (III/3)	4 kV
Rated current	25 A
Legend (ratings)	(III / 3) ≙ Overvoltage category III / Pollution degree 3

Subject to changes. Please also observe the further product documentation!

WAGO Kontakttechnik GmbH & Co. KG
Hansastr. 27
32423 Minden
Phone: +49571 887-0 | Fax: +49571 887-169
Email: info.de@wago.com | Web: www.wago.com

Do you have any questions about our products?
We are always happy to take your call at +49 (571) 887-44222.



Physical data

Width	190 mm / 7.48 inch
Height	30 mm / 1.181 inch
Depth	145 mm / 5.709 inch

Mechanical data

Internal wiring	4 mm ²
Application	General mains applications
Coding	A
Mounting type	Wall, screw mount Installation on mounting plate
Protection type	IP20
Note on protection type	When mated: IP2xC (These compact connectors are not designed for use in open, easily accessible areas!)

Plug-in connection

Mismating protection	Yes
Note on mismating protection	All WINSTA [®] components are 100% protected against mismating when: a.) plugging different numbers of poles b.) plugging while rotated 180 c.) plugging while laterally staggered d.) plugging one pole
Locking of plug-in connection	locking lever

Material data

Color	black
Insulation material	Polyamide (PA66)
Contact material	Copper or copper alloy (surface-treated)
Fire load	7.404 MJ
Weight	333.2 g

Environmental requirements

Processing temperature	-5 ... +40 °C
Continuous operating temperature	-35 ... +85 °C
Note on continuous operating temperature	Insulating parts for temperatures ≤ 105 °C

Subject to changes. Please also observe the further product documentation!













WAGO Kontakttechnik GmbH & Co. KG
 Hansastr. 27
 32423 Minden
 Phone: +49571 887-0 | Fax: +49571 887-169
 Email: info.de@wago.com | Web: www.wago.com

Do you have any questions about our products?
 We are always happy to take your call at +49 (571) 887-44222.

Commercial data







Packaging type	BOX
Country of origin	DE
GTIN	4055143296243
Customs tariff number	85366990990

Counterpart

	Item no.770-103 Socket; with strain relief housing; 3-pole; Cod. A; 4,00 mm ² ; black	www.wago.com/770-103
	Item no.770-113 Plug; with strain relief housing; 3-pole; Cod. A; 4,00 mm ² ; black	www.wago.com/770-113
	Item no.770-123 Socket; with strain relief housing; 3-pole; Cod. A; 4,00 mm ² ; white	www.wago.com/770-123
	Item no.770-133 Plug; with strain relief housing; 3-pole; Cod. A; 4,00 mm ² ; white	www.wago.com/770-133
	Item no.770-203 Socket; 3-pole; Cod. A; 4,00 mm ² ; black	www.wago.com/770-203
	Item no.770-203/035-000 Socket; with strain relief housing; 3-pole; Cod. A; 4,00 mm ² ; black	www.wago.com/770-203/035-000
	Item no.770-213 Plug; 3-pole; Cod. A; 4,00 mm ² ; black	www.wago.com/770-213
	Item no.770-213/035-000 Plug; with strain relief housing; 3-pole; Cod. A; 4,00 mm ² ; black	www.wago.com/770-213/035-000
	Item no.770-223 Socket; 3-pole; Cod. A; 4,00 mm ² ; white	www.wago.com/770-223
	Item no.770-223/035-050 Socket; with strain relief housing; 3-pole; Cod. A; 4,00 mm ² ; white	www.wago.com/770-223/035-050
	Item no.770-233 Plug; 3-pole; Cod. A; 4,00 mm ² ; white	www.wago.com/770-233
	Item no.770-233/035-050 Plug; with strain relief housing; 3-pole; Cod. A; 4,00 mm ² ; white	www.wago.com/770-233/035-050

Subject to changes. Please also observe the further product documentation!



	Item no.771-9993/006-101 pre-assembled interconnecting cable; Eca; Socket/plug; 3-pole; Cod. A; H05VV-F 3G 1.5 mm ² ; 1 m; 1,50 mm ² ; black	www.wago.com/771-9993/006-101
	Item no.771-9993/006-102 pre-assembled interconnecting cable; Eca; Socket/plug; 3-pole; Cod. A; H05VV-F 3G 1.5 mm ² ; 1 m; 1,50 mm ² ; white	www.wago.com/771-9993/006-102
	Item no.771-9993/106-101 pre-assembled connecting cable; Eca; Socket/open-ended; 3-pole; Cod. A; H05VV-F 3G 1.5 mm ² ; 1 m; 1,50 mm ² ; black	www.wago.com/771-9993/106-101
	Item no.771-9993/106-102 pre-assembled connecting cable; Eca; Socket/open-ended; 3-pole; Cod. A; H05VV-F 3G 1.5 mm ² ; 1 m; 1,50 mm ² ; white	www.wago.com/771-9993/106-102
	Item no.771-9993/206-101 pre-assembled connecting cable; Eca; Plug/open-ended; 3-pole; Cod. A; H05VV-F 3G 1.5 mm ² ; 1 m; 1,50 mm ² ; black	www.wago.com/771-9993/206-101
	Item no.771-9993/206-102 pre-assembled connecting cable; Eca; Plug/open-ended; 3-pole; Cod. A; H05VV-F 3G 1.5 mm ² ; 1 m; 1,50 mm ² ; white	www.wago.com/771-9993/206-102

Compatible products

assembling

	Item no.: 770-680 Mounting plate; for distribution boxes	www.wago.com/770-680
-----------------------------------------------------------------------------------	--------------------------------------------------------------------	----------------------------------------------------------------

Downloads

Documentation

Bid Text

899-631/327-000 X81 - Datei	19. 2. 2019	xml 3.6 kB	Download
899-631/327-000 doc - Datei	23. 2. 2015	doc 26.1 kB	Download

Environmental Product Compliance

Compliance Search

Environmental Product Compliance 899-631/327-000 Distribution box; Single-phase current (230 V); 2 inputs; 6 outputs; Cod. A; MIDI; black	URL	Download
----------------------------------------------------------------------------------------------------------------------------------------------	-----	----------

Subject to changes. Please also observe the further product documentation!

Installation Notes

Installation



Securing the mounting plate with WINSTA®
Distribution Box to the wall (e.g., via stud gun).

Product family

WINSTA® Boxen

WINSTA® ist das Steckverbindersystem, das optimal auf die hohen Anforderungen in der Gebäudeinstallation zugeschnitten ist. Es macht die Elektroinstallation steckbar und dadurch schnell, sicher und fehlerfrei. Dies gilt auch in weiteren Anwendungen wie z. B. im Schiffbau, in der Bahntechnik oder in der Industrie.

[Show all products from the family](#)

Subject to changes. Please also observe the further product documentation!