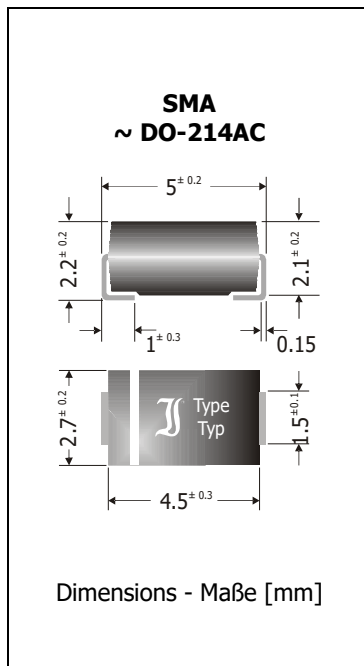

S1YL
Standard Recovery SMD Rectifier Diodes
SMD-Gleichrichterdioden mit Standard-Sperrverzug

$I_{FAV} = 1 \text{ A}$	$V_{RRM} = 2000 \text{ V}$
$V_F < 1.1 \text{ V}$	$I_{FSM} = 22/25 \text{ A}$
$T_{jmax} = 150^\circ\text{C}$	$t_{rr} \sim 1500 \text{ ns}$

Version 2019-01-29

**Typical Applications**

50/60 Hz Mains Rectification,
 Smart Meter Input Stage
 Power Supplies, Polarity Protection
 Commercial grade
 Suffix -Q: AEC-Q101 compliant ¹⁾
 Suffix -AQ: in AEC-Q101 qualification ¹⁾

Features

Budget version of S1Y
 Glass passivated junction
 V_{RRM} of 2000 V
 Compliant to RoHS, REACH,
 Conflict Minerals ¹⁾

Mechanical Data ¹⁾

Taped and reeled	7500 / 13"
Weight approx.	0.07 g
Case material	UL 94V-0
Solder & assembly conditions	260°C/10s
	MSL = 1

Typische Anwendungen

50/60 Hz Netzgleichrichtung,
 Eingangsstufe elektron. Stromzähler
 Stromversorgungen, Verpolschutz
 Standardausführung
 Suffix -Q: AEC-Q101 konform ¹⁾
 Suffix -AQ: in AEC-Q101 Qualifikation ¹⁾

Besonderheiten

Budget-Version der S1Y
 Glasspassivierte Sperrschicht
 V_{RRM} von 2000 V
 Konform zu RoHS, REACH,
 Konfliktmineralien ¹⁾

Mechanische Daten ¹⁾

Gegurtet auf Rolle
Gewicht ca.
Gehäusematerial
Löt- und Einbaubedingungen

Maximum ratings ²⁾**Grenzwerte ²⁾**

Type Typ	Repetitive peak reverse voltage Periodische Spitzensperrspannung V_{RRM} [V]	Surge peak reverse voltage Stoßspitzensperrspannung V_{RSM} [V]
S1YL/-Q	2000	2000

Max. average forward rectified current – Dauergrenzstrom in Einwegschaltung	$T_T = 100^\circ\text{C}$	I_{FAV}	1 A
Repetitive peak forward current – Periodischer Spitzenstrom	$f > 15 \text{ Hz}$ $T_T = 100^\circ\text{C}$	I_{FRM}	4 A
Peak forward surge current Stoßstrom in Fluss-Richtung	Half sine-wave 50 Hz (10 ms) Sinus-Halbwellen 60 Hz (8.3 ms)	I_{FSM}	22 A 25 A
Rating for fusing – Grenzlastintegral	$t < 10 \text{ ms}$	i^2t	2.4 A ² s
Non-repetitive peak reverse avalanche energy – Einmalige Impulsenergie in Sperr-Richtung		E_{RSM}	N/A
Junction temperature – Sperrschichttemperatur		T_j	-50...+150°C
Storage temperature – Lagerungstemperatur		T_s	-50...+150°C

Characteristics**Kennwerte**

Forward voltage – Durchlass-Spannung	$T_j = 25^\circ\text{C}$	$I_F = 1 \text{ A}$	V_F	< 1.1
Leakage current Sperrstrom	$T_j = 25^\circ\text{C}$ $T_j = 100^\circ\text{C}$	$V_R = V_{RRM}$	I_R	< 5 μA < 50 μA
Reverse recovery time – Sperrverzug	$I_F = 0.5 \text{ A} \rightarrow I_R = 1 \text{ A} \rightarrow I_R = 0.25 \text{ A}$		t_{rr}	typ. 1500 ns
Typ. thermal resistance junction-ambient – Typ. Wärmewiderstand Sperrschicht-Umgebung			R_{thA}	75 K/W ³⁾
Typ. thermal resistance junction-terminal – Typ. Wärmewiderstand Sperrschicht-Anschluss			R_{thT}	30 K/W

¹⁾ Please note the [detailed information on our website](#) or at the beginning of the data book

Bitte beachten Sie die [detaillierten Hinweise auf unserer Internetseite](#) bzw. am Anfang des Datenbuches

²⁾ $T_A = 25^\circ\text{C}$ unless otherwise specified – $T_A = 25^\circ\text{C}$ wenn nicht anders angegeben

³⁾ Mounted on PCB with 25 mm² copper pads per terminal – Montage auf Leiterplatte mit 25 mm² Kupferpad je Anschluss

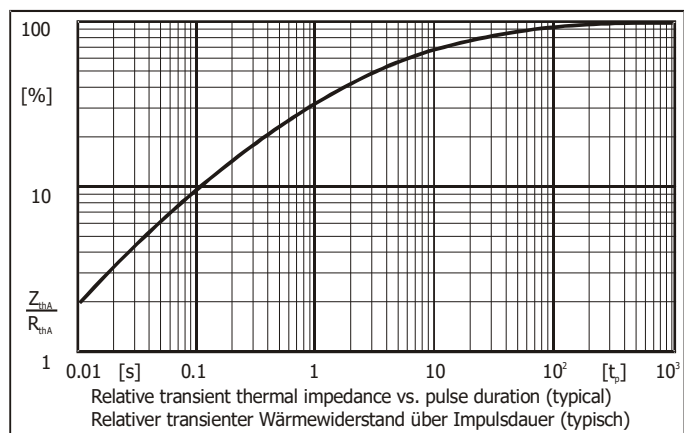
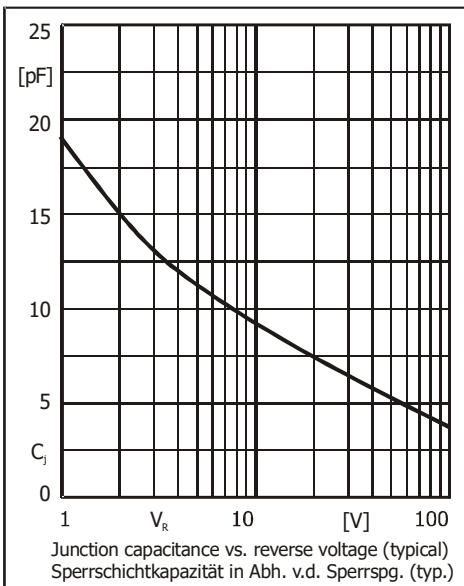
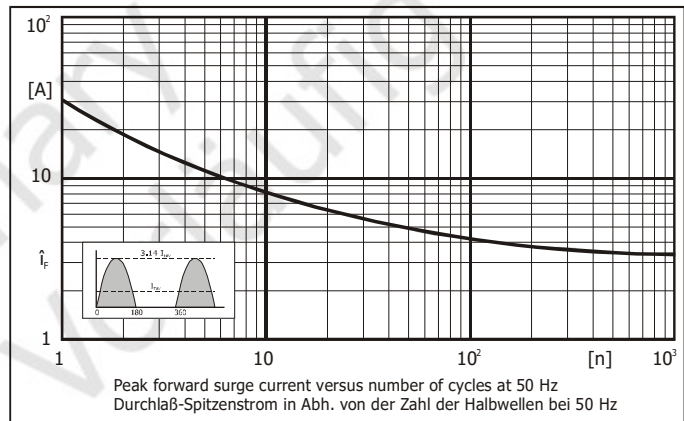
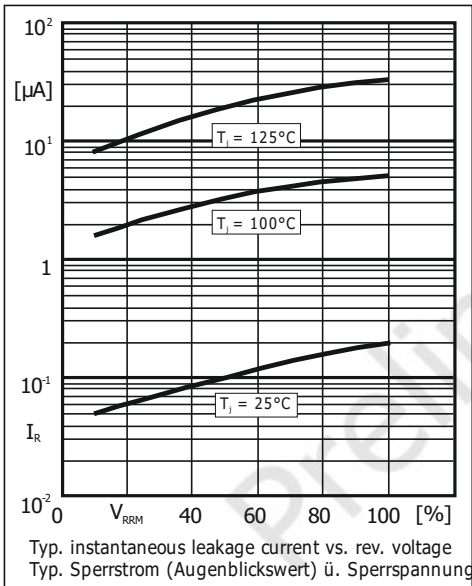
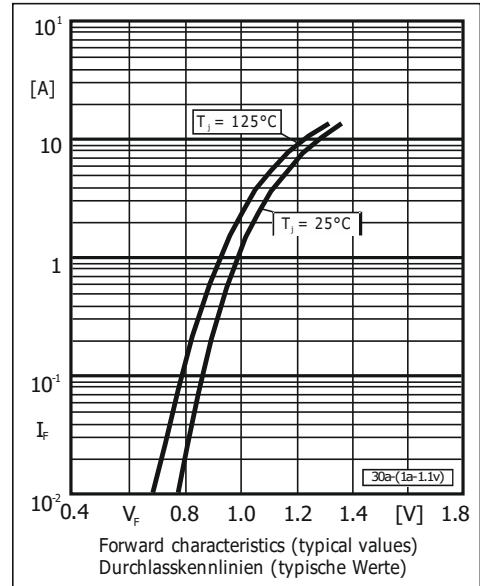
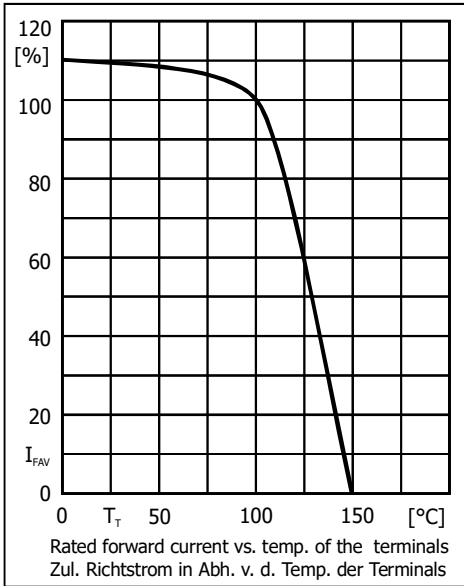

Disclaimer: See data book page 2 or [website](#)
Haftungsausschluss: Siehe Datenbuch Seite 2 oder [Internet](#)