

MVSP25x-10,16-H euroclamp

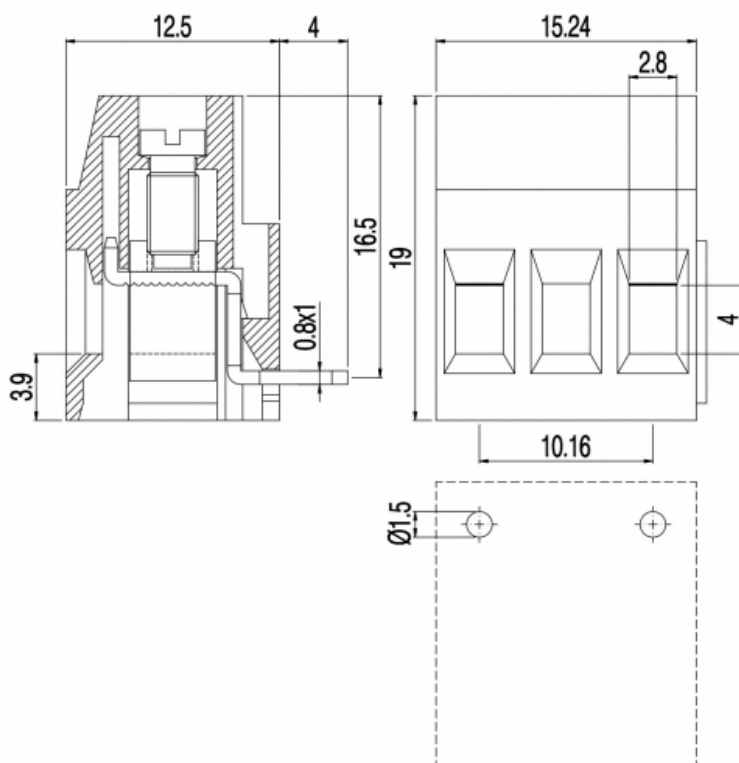

Single-deck terminal block - Modular version - Pitch 10,16mm - 1÷2 poles

GENERAL INFORMATION

pitch:	10,16 mm
housing height:	19,00 mm
housing depth:	12.5 mm
dimensional class:	medium
wire section:	2.5 mm ² / 14 AWG
clamp opening size:	2.8 × 4 mm
wire stripping:	max 9.5 mm
operating temperature:	-40°C ÷ +130°C

ELECTRICAL CHARACTERISTICS

current:	24A
voltage:	750V
test voltage:	3 kVrms/60s

MECHANICAL CHARACTERISTICS

screw:	M3
max. torque:	0.8 Nm / 7.2 in.lbs

APPROVALS DATA



EN 60998-1
 current: 24A
 voltage: 750V
 wire section: 2.5mm²
 torque: 0.8Nm
 FILE: CA02.00599









-
-
-
-
-



UL 1059
 18A factory / 15A field
 300V
 14÷30AWG
 4.5Lb-in
 E178356

MATERIALS

AVAILABLE COLOURS

housing: PA - UL 94 V0  (STD)      

screw: Galvanized steel

clamp/spring: Nickeled copper alloy other colours: upon request

terminal: Tin-plated copper alloy

poles	P/N	pcs/pack	W [Kg]*	W [Kg]*
1	MVSP251-10,16-H	N/A	N/A	N/A
2	MVSP252-10,16-H	N/A	N/A	N/A
..	MVSP25..-10,16-H	N/A	N/A	N/A