

DATASHEET

Type	Multiband antenna
Frequencies	AMPS (824-894 MHz) ISM (868 MHz) GSM (900 MHz) DCS (1800 MHz) PCS (1900 MHz) 3G (UMTS 2.1 GHz)
Mounting	Magnetic Mount
Part No.	2J302M
Revision	00



P. Tipul

D. Noble

1. SPECIFICATION

1.1. Electrical Specifications

Frequencies	AMPS (824-894 MHz) ISM (868 MHz) GSM (900 MHz) DCS (1800 MHz) PCS (1900 MHz) 3G (UMTS 2.1 GHz)
Impedance	50 Ohms
Polarization	VERTICAL
Gain	2.2 dBi Max
VSWR	<2:1
Power handling	25W
Operating temperature	-40°C to +85°C

1.2. Connection Specifications

Connector type: SMA male
Cable: RG174U
Cable length: 250 cm

For different cable and connector please ask our sales team.

1.3. Mechanical Specifications and Dimensions

1.3.1. Magnetic Mount

Material: Base: ABS / Whip: Stainless Steel with black chrome finish
Max. dimensions: 31mm x 90.45mm (D x H)
Weight: 62 g 'weight with default connection'
Colour: Black (for different colours please ask our sales team)

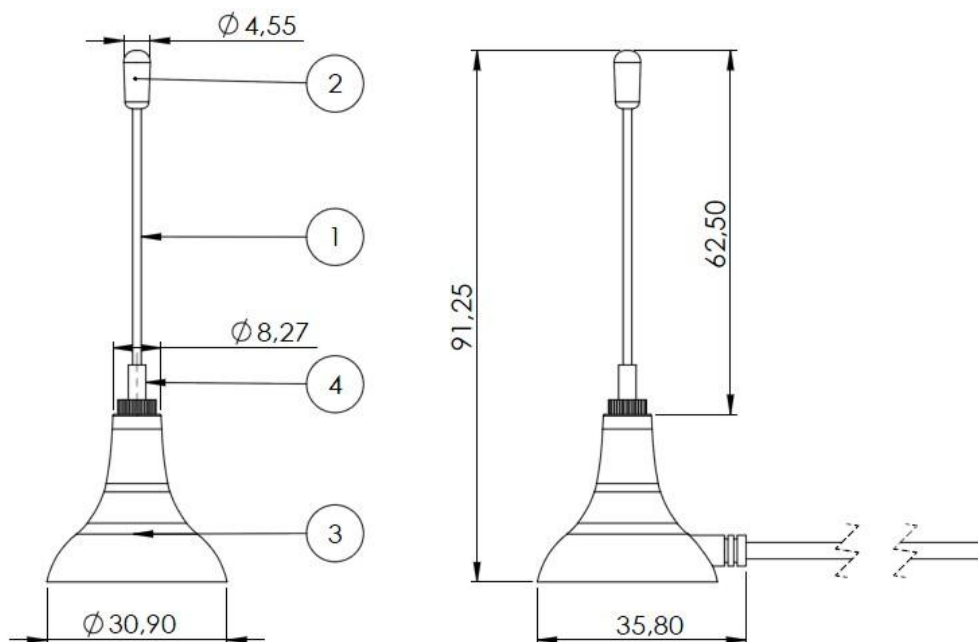

2. MEASUREMENT

3D radiation pattern
 Freq = 0.907GHz Az= 45 EL= 45

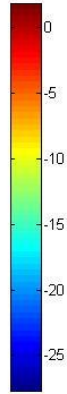
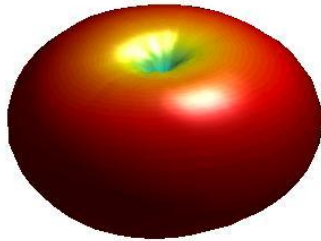

Plane radiation pattern

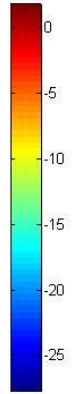
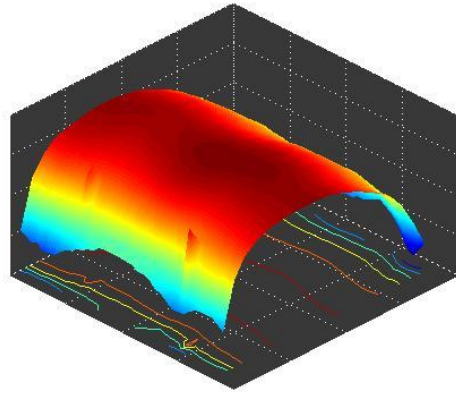

Tested with 15cm cable length.

Tested with 15cm cable length

Log Mag (Quad Band)

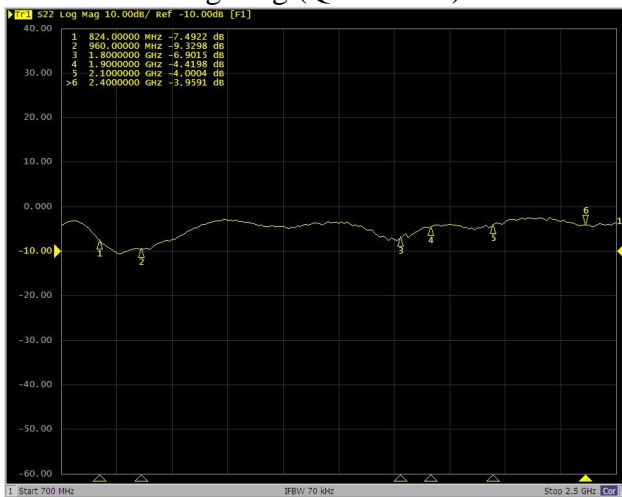

Tested with 15cm cable length.

VSWR (Quad Band)

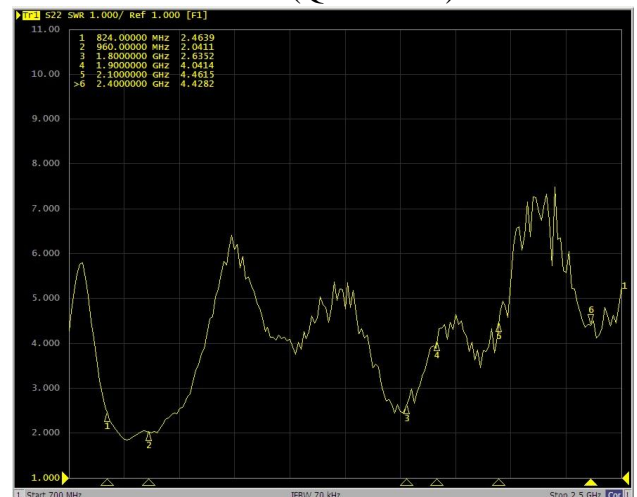

Tested with 15cm cable length.

Log Mag (Quad Band)

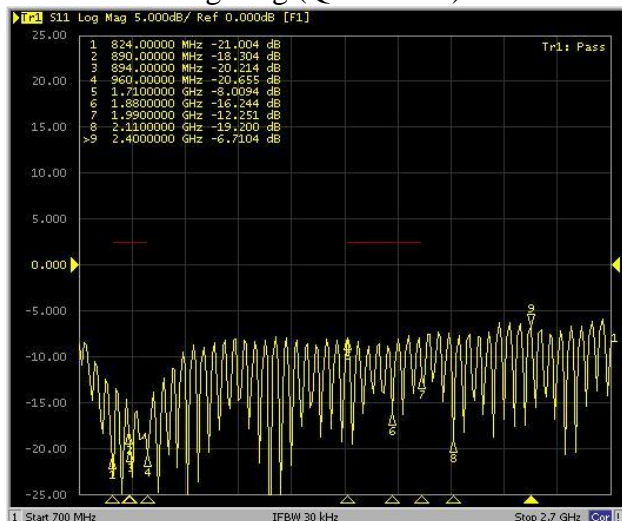

Tested with 2.5m cable length.

VSWR (Quad Band)

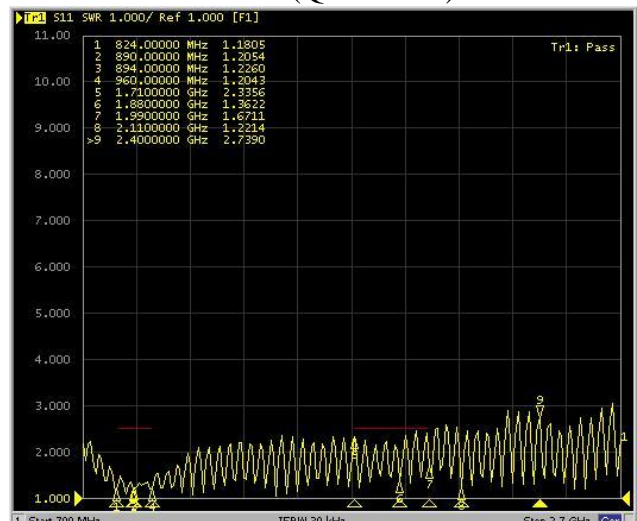

Tested with 2.5m cable length.