

DISPLAY Elektronik GmbH

TFT MODULE

**DEM 1024600G1 TMH-PW-N
(A-TOUCH)**

**7,0" TFT +
4-Wire-Resistive Touch**

Product Specification

Version: 0

05.07.2019

Revision History

VERSION	DATE	REVISED PAGE NO.	Note
0	05.07.2019		First Issue

Contents

1. Summary
2. General Specification
3. Interface
4. Contour Drawing
5. Absolute Maximum Ratings
6. Electrical Characteristics
7. Operation Sequence
8. Optical Characteristics
9. Reliability
10. Touch Panel Information
11. Other

DEM 1024600G1 TMH-PW-N(A-TOUCH) Product Specification

1. Summary

TFT 7.0" is a TN transmissive type color active matrix TFT liquid crystal display that use amorphous silicon TFT as switching devices. This module is a composed of a TFT_LCD module, It is usually designed for industrial application and this module follows RoHS.

2. General Specifications

- Size: 7.0 Inch
- Dot Matrix: 1024 x RGB x 600 Dots
- Module Dimension: 165.00 x 99.80 x 7.15 mm
- Active Area: 154.21 x 85.92 mm
- Dot Pitch: 0.1506 x 0.1432 mm
- LCD Type: TFT, Normally White, Transmissive
- View Direction: 12 o'clock
- Gray Scale Inversion Direction: 6 o'clock
- Aspect Ratio: 16:9
- Backlight Type: LED, Normally White
- Control IC: NA
- Driver IC: EK79001HE + EK73215BCGA
- With /Without TP: With RTP
- Interface: LVDS
- Surface: Anti-Glare

*Color tone slight changed by temperature and driving voltage.

DEM 1024600G1 TMH-PW-N(A-TOUCH) Product Specification

3. Interface

3.1. LCM PIN Definition

FPC Connector is used for the module electronics interface. The recommended model is FH12A-40S-0.5SH manufactured by Hirose.

Pin No.	Symbol	I/O	Function	Remark
1	VCOM	P	Common Voltage	
2	VDD	P	Digital Circuit	
3	VDD	P	Digital Circuit	
4	NC	---	No Connection	
5	Reset	I	Global Reset Pin	
6	STBYB	I	Standby Mode, Normally pulled High STBYB = "1", Normal Operation STBYB = "0", Timing Controller, Source Driver will turn Off, all Output are High-Z	
7	GND	P	Ground	
8	RXIN0-	I	Negative LVDS Differential Data Input	
9	RXIN0+	I	Positive LVDS Differential Data Input	
10	GND	P	Ground	
11	RXIN1-	I	Negative LVDS Differential Data Input	
12	RXIN1+	I	Positive LVDS Differential Data Input	
13	GND	P	Ground	
14	RXIN2-	I	Negative LVDS Differential Data Input	
15	RXIN2+	I	Positive LVDS Differential Data Input	
16	GND	P	Ground	
17	RXCLKIN-	I	Negative LVDS Differential Clock Input	
18	RXCLKIN+	I	Positive LVDS Differential Clock Input	
19	GND	P	Ground	
20	RXIN3-	I	Negative LVDS Differential Data Input	
21	RXIN3+	I	Positive LVDS Differential Data Input	
22	GND	P	Ground	
23	NC	---	No Connection	
24	NC	---	No Connection	

DEM 1024600G1 TMH-PW-N(A-TOUCH) Product Specification

25	GND	P	Ground	
26	NC	---	No Connection	
27	DIMO	O	Backlight CABC Controller Signal Output	
28	SELB	I	6Bit/8Bit Mode Select H:6Bit / L:8Bit	
29	AVDD	P	Power for Analog Circuit	
30	GND	P	Ground	
31	LED-	P	LED Cathode	
32	LED-	P	LED Cathode	
33	L/R	I	Horizontal Inversion	
34	U/D	I	Vertical Inversion	
35	VGL	P	Negative Power for TFT	
36	GND	P	Ground	
37	GND	P	Ground	
38	VGH	P	Positive Power for TFT	
39	LED+	P	LED Anode	
40	LED+	P	LED Anode	

I: Input, O: Output, P: Power

Note

When L/R="0", set right to left scan direction.

When L/R="1", set left to right scan direction.

When U/D="0", set top to bottom scan direction.

When U/D="1", set bottom to top scan direction.

DEM 1024600G1 TMH-PW-N(A-TOUCH) Product Specification

4. Contour Drawing

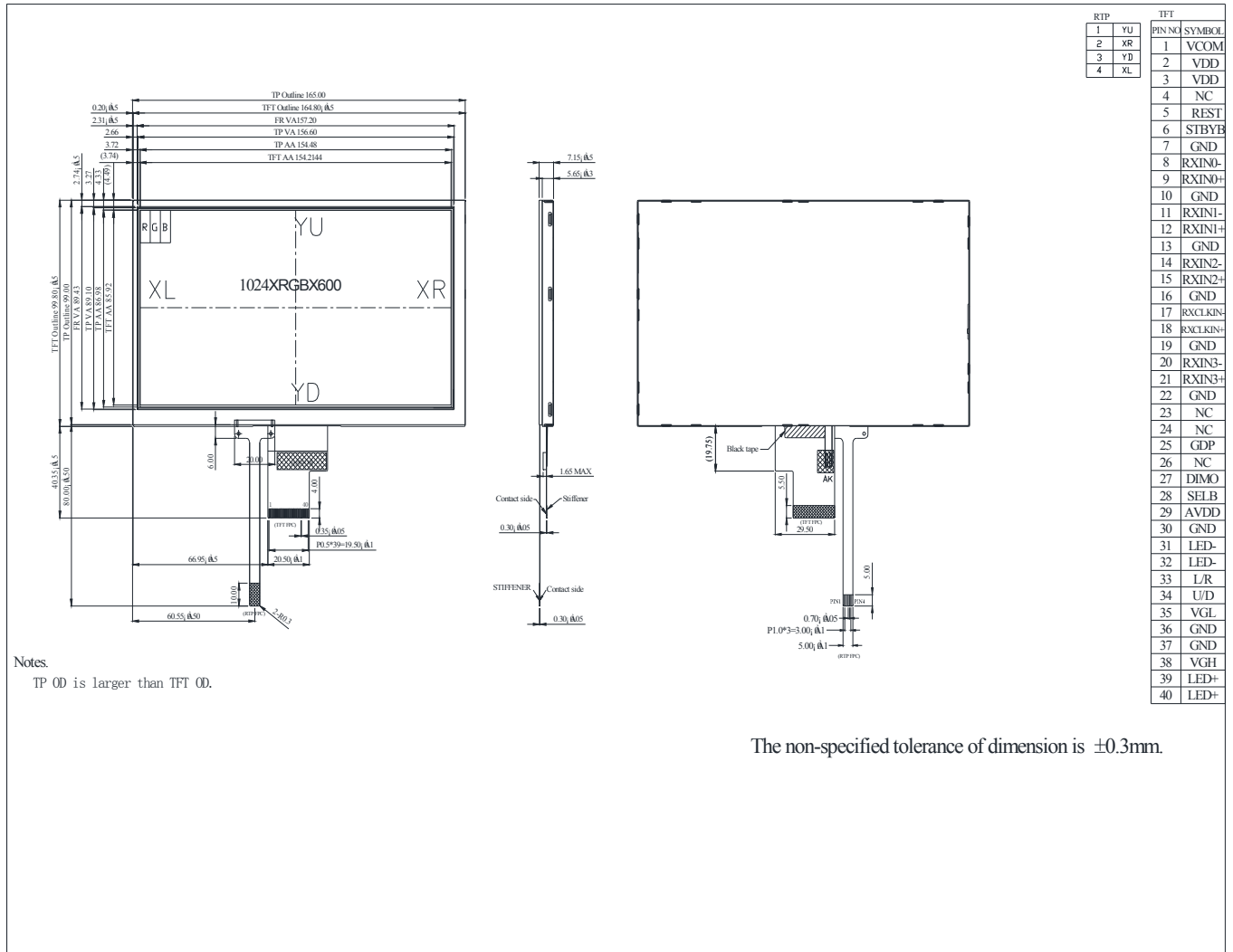

DEM 1024600G1 TMH-PW-N(A-TOUCH) Product Specification

5. Absolute Maximum Ratings

Item	Symbol	Min	Typ	Max	Unit
Operating Temperature	TOP	-20	—	+70	°C
Storage Temperature	TST	-30	—	+80	°C

Note: Device is subject to be damaged permanently if stresses beyond those absolute maximum ratings listed above

1. Temp. $\leq 60^{\circ}\text{C}$, 90% RH MAX. Temp. $> 60^{\circ}\text{C}$, Absolute humidity shall be less than 90% RH at 60°C

DEM 1024600G1 TMH-PW-N(A-TOUCH) Product Specification

6. Electrical Characteristics

6.1. Typical Operation Conditions

(Note 1)

Item	Symbol	Values			Unit	Remark
		Min.	Typ.	Max.		
Power Voltage	DVDD	3.0	3.3	3.6	V	Note 2
	AVDD	9.4	9.6	9.8	V	
	VGH	17	18	19	V	
	VGL	-6.6	-6.0	-5.4	V	
Input Signal Voltage	VCOM	3.1	3.3	3.6	V	
Input Logic High Voltage	VIH	0.7 DVDD	-	DVDD	V	Note 3
Input Logic Low Voltage	VIL	0	-	0.3 DVDD	V	

Note 1: Be sure to apply DVDD and VGL to the LCD first, and then apply VGH.

Note 2: DVDD setting should match the signals output voltage (refer to Note 3) of customer's system board.

Note 3: DCLK,HS,VS,RESET,U/D,L/R,DE,R0~R7,G0~G7,B0~B7,MODE,DITHB.

6.2. Current Consumption

Item	Symbol	Values			Unit	Remark
		Min.	Typ.	Max.		
Current for Driver	IGH	-	0.2	1.0	mA	VGH =18.0V
	IGL	-	0.2	1.0	mA	VGL = -6.0V
	IDVDD	-	4.0	10	mA	DVDD =3.3V
	IAVDD	-	20	50	mA	AVDD =9.6V

DEM 1024600G1 TMH-PW-N(A-TOUCH) Product Specification

6.3. Backlight Driving Conditions

Item	Symbol	Values			Unit	Remark
		Min.	Typ.	Max.		
Voltage for LED Backlight	VL	8.4	9.8	10.8	V	Note 1
Current for LED Backlight	IL	--	300	--	mA	
LED Lifetime	-	-	50,000	-	Hr	Note 2

Note 1: The LED Supply Voltage is defined by the number of LED at Ta=25°C and IL =300mA.

Note 2: The “LED life time” is defined as the module brightness decrease to 50% original brightness at Ta=25°C and IL =300mA. The LED lifetime could be decreased if operating IL is larger than 300mA.

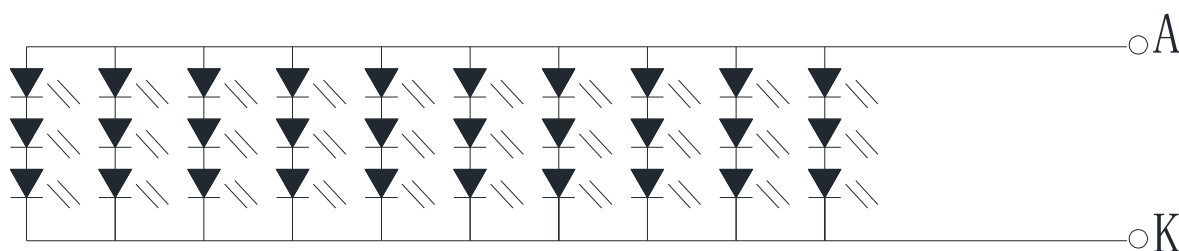

Backlight 30LED Circuit

DEM 1024600G1 TMH-PW-N(A-TOUCH) Product Specification

7. Operation Sequence

7.1. Power Sequence

In order to prevent IC from power on reset fail, the time (TPOR) of the digital power supply VDD should be maintained within the given specifications. Refer to “AC characteristics” for more detail on timing.

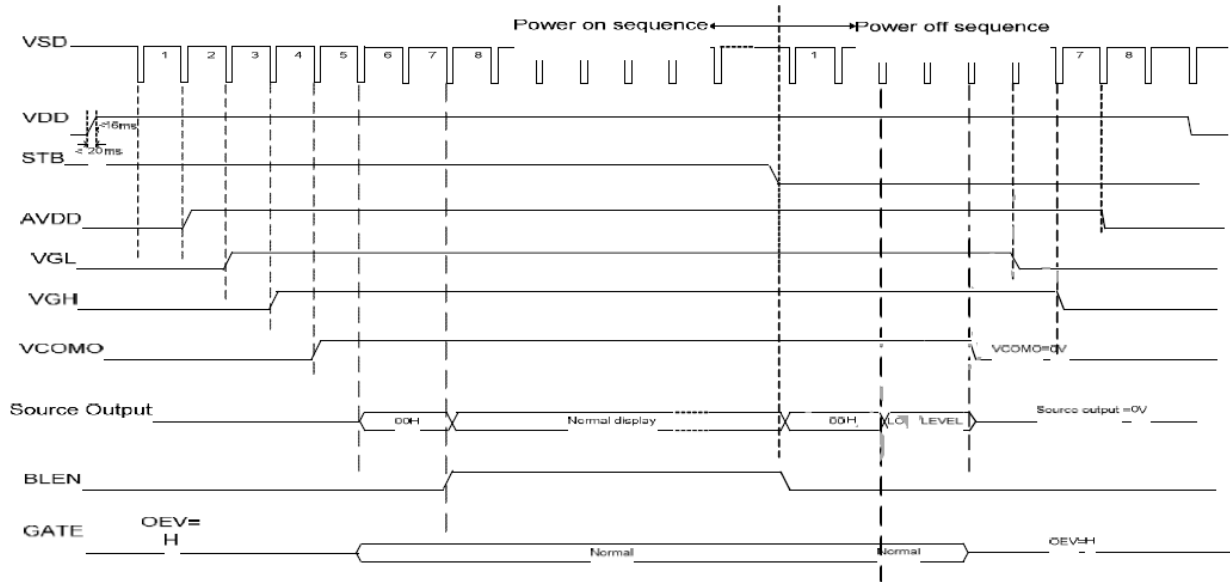

Power On/Off Timing Chart

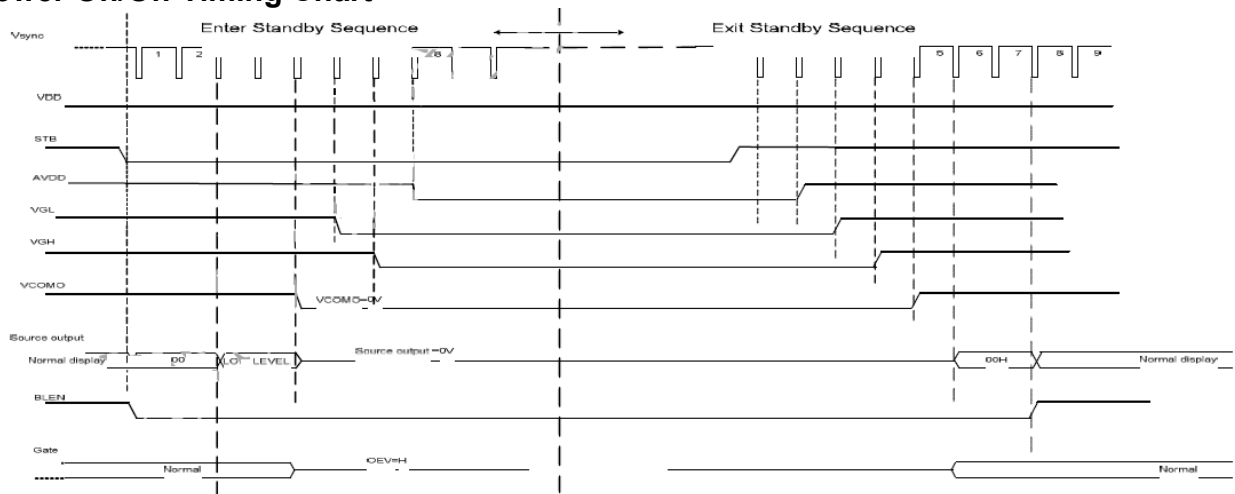

Enter and Exit standby Mode timing chart

Note: Low level=3Fh, when NBW=L (normally white)
 Low level=00h, when NBW=H (normally black)

DEM 1024600G1 TMH-PW-N(A-TOUCH) Product Specification

7.2. Timing Characteristics

AC Electrical Characteristics

Parameter	Symbol	condition	Min.	Typ.	Max.	Unit
Clock Frequency	RxFCLK		20	-	71	MHz
Input Data Skew Margin	T _{RSKM}	VID =400mV RxVCM=1.2V RxFCLK=71MHz	500	-	-	ps
Clock High Time	TLVCH		-	4/(7* RxFCLK)	-	ns
Clock Low Time	TLVCL		-	3/(7* RxFCLK)	-	ns
PLL Wake-Up-Time	TenPLL				150	us

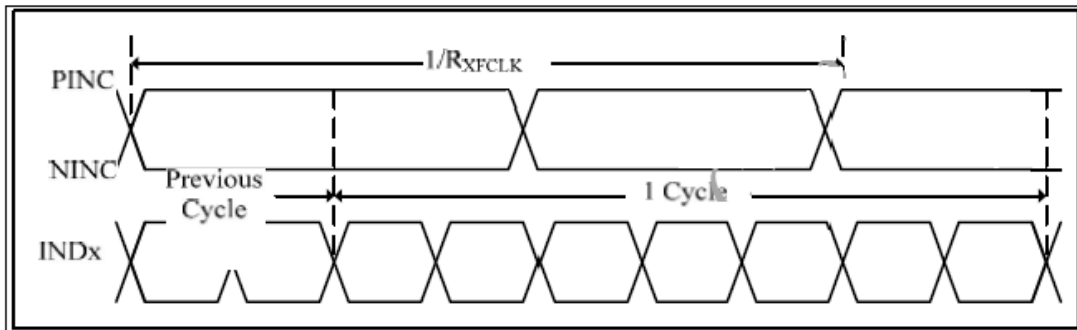

LVDS timing(1)

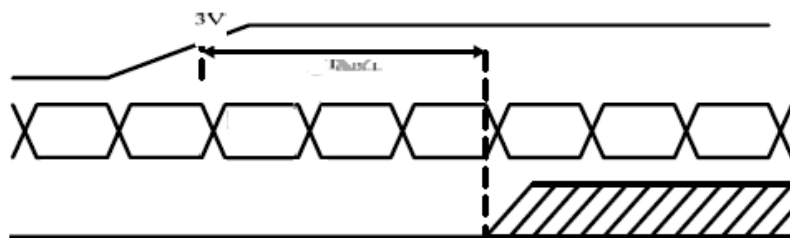

LVDS timing(2)

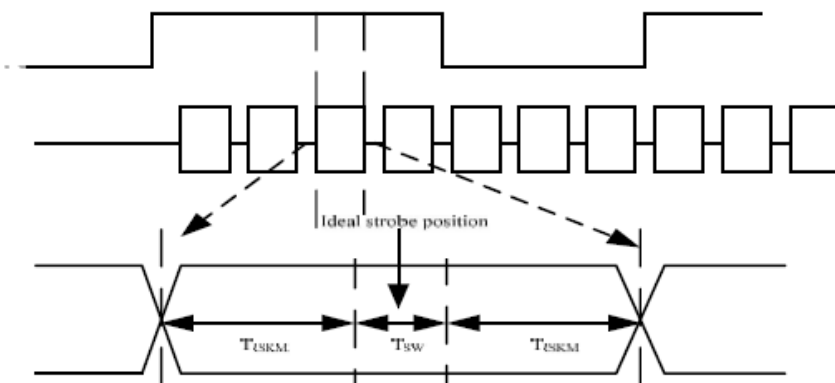

T_{sw}: Receiver strobe position
T_{RSKM}: Receiver strobe margin

LVDS timing(3)

DEM 1024600G1 TMH-PW-N(A-TOUCH) Product Specification

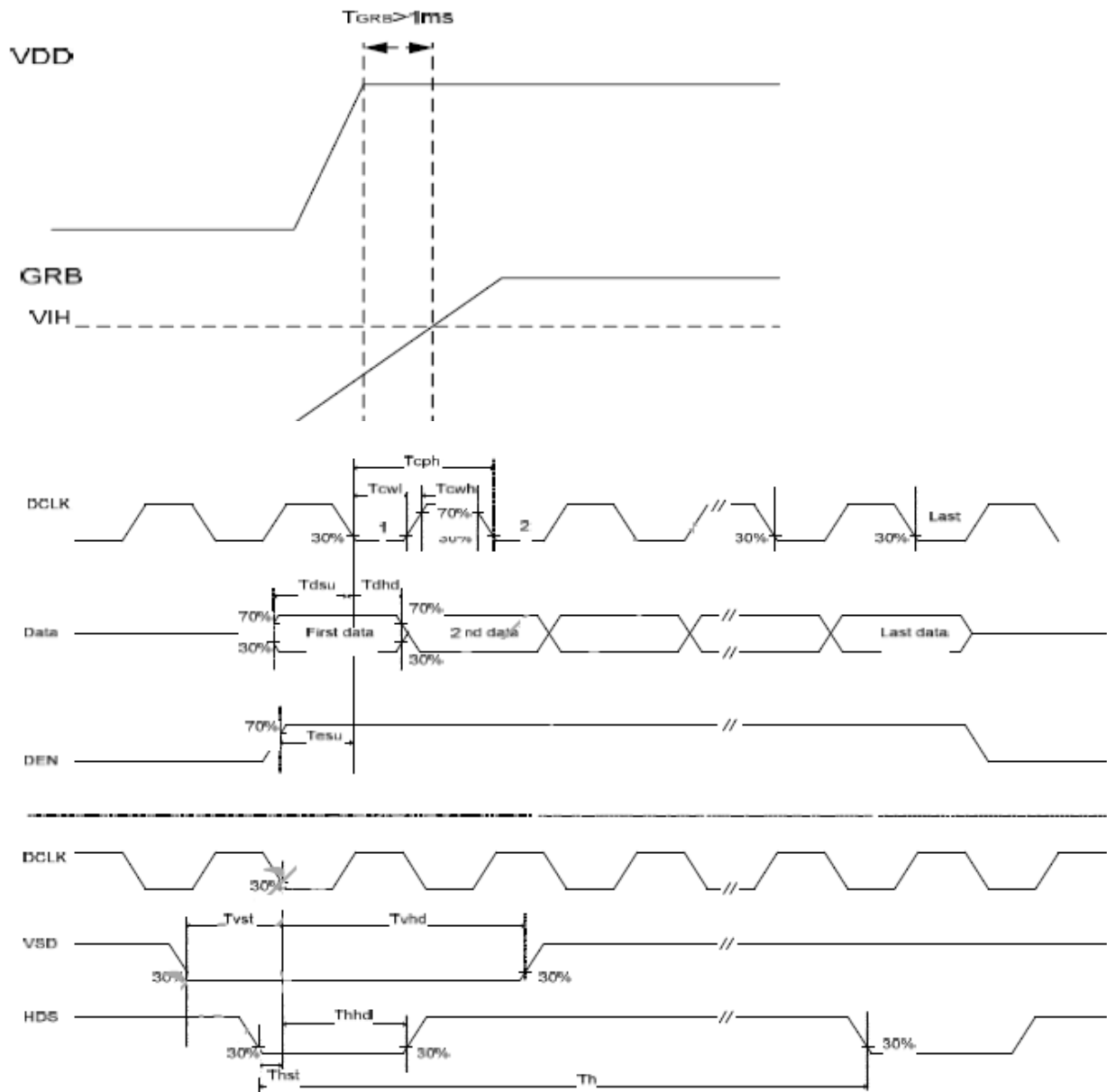

Parallel Input Clock and Data timing

DEM 1024600G1 TMH-PW-N(A-TOUCH) Product Specification

7.3. LVDS DC Characteristics

Parameter	Symbol	Min.	Typ.	Max.	Unit	Remark
Differential Input High Threshold Voltage	RxVTH	-	-	+0.1		
Differential Input Low Threshold Voltage	RxVTL	-0.1	-	-	V	
Input Voltage Range (singled-end)	RxVIN	0	-	2.4	V	
Differential Input Common Mode Voltage	RxVCM	VID /2	-	2.4- VID /2	V	
Differential Input Voltage	VID	0.2	-	0.6	V	
Differential Input Leakage Current	RVxliz	-10	-	+10	uA	
LVDS Digital operating Current	Iddlvds	-	40(TBD)	50	mA	Fclk=65Mhz VDD=3.3V
LVDS Digital Standby Current	Istlvds	--	10(TBD)	50	uA	Clock & all Functions are

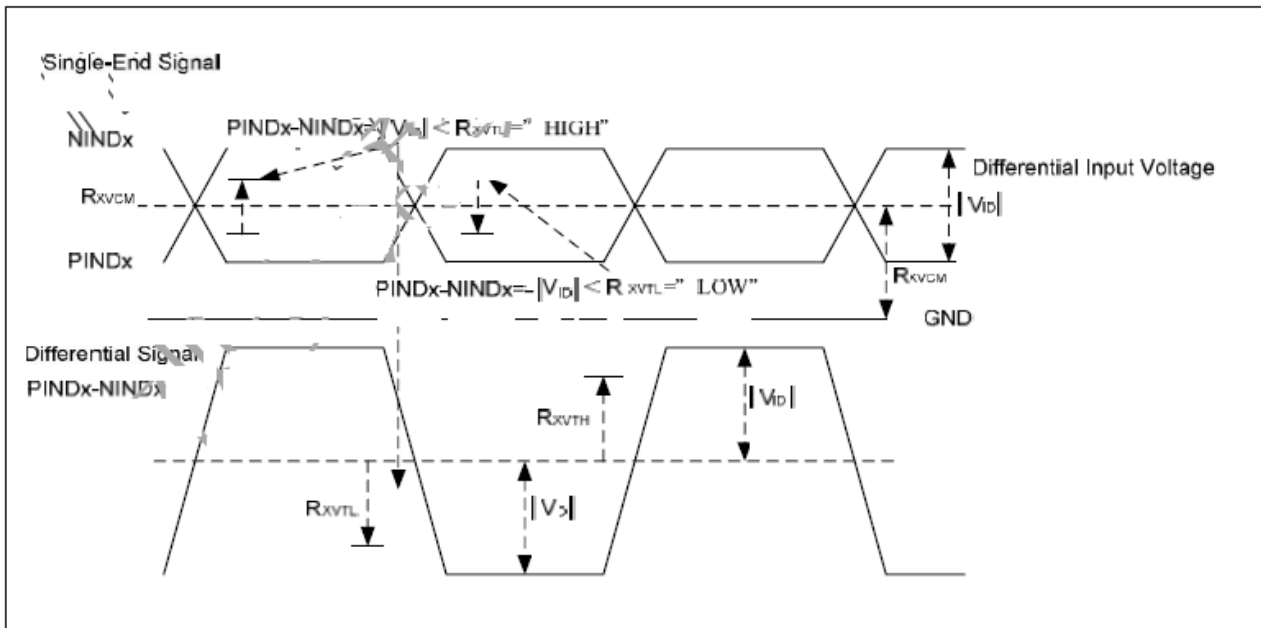

LVDS DC Characteristics

DEM 1024600G1 TMH-PW-N(A-TOUCH) Product Specification

HV Mode (1)

HV Mode

Horizontal Input Timing

Parameter		Symbol	Value			Unit
Horizontal Display Area		thn	1024			DCLK
DCLK Frequency @ Frame Rate=60hz		fclk	Min.	Typ.	Max.	Mhz
			44.9	51.2	63	
1 Horizontal Line		Th	1200	1344	1400	DCLK
HSYNC Pulse Width		thpw	1			
			-			
			140			
HSYNC Back Porch		thbp	160	160	160	
HSYNC Front Porch		thfp	16	160	216	

HV Mode (2)

Parameter	Symbol	Value			Unit
		Min.	Typ.	Max.	
Vertical Display Area	tvd	600			H
VSYNC Period Time	tv	624	635	750	H
VSYNC Pulse Width	tpw	1	-	20	H
VSYNC Back Porch	tvb	23	23	23	H
VSYNC Front Porch	tvfp	1	12	127	H

DEM 1024600G1 TMH-PW-N(A-TOUCH) Product Specification

Data Input Format

6Bit LVDS Input (HSD="H")

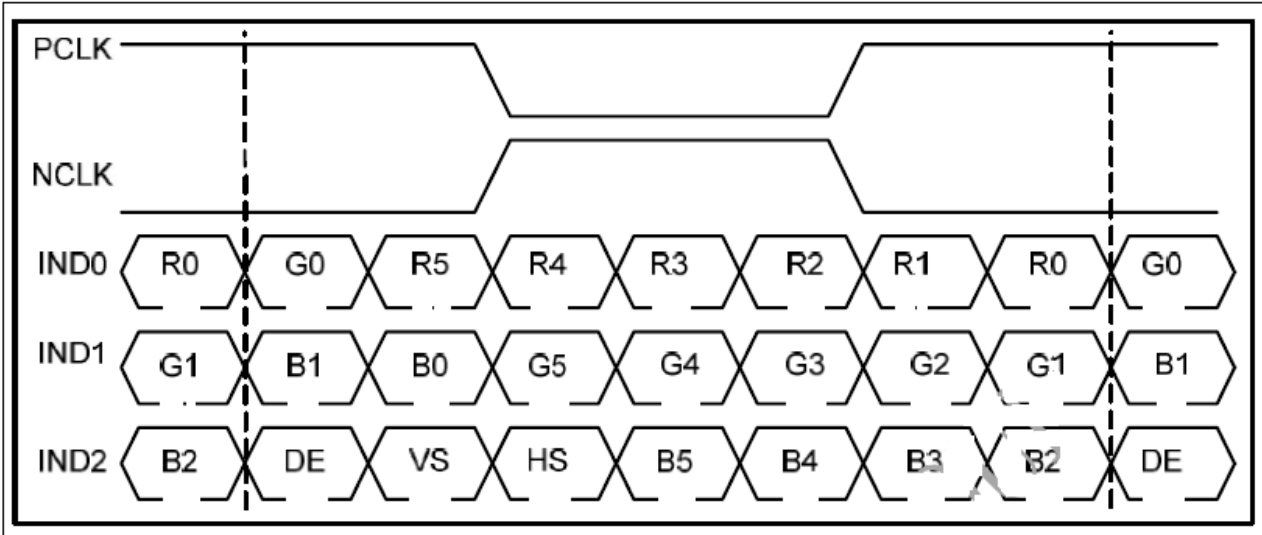

6-bit LVDS input timing chart

8Bit LVDS Input (HSD="L")

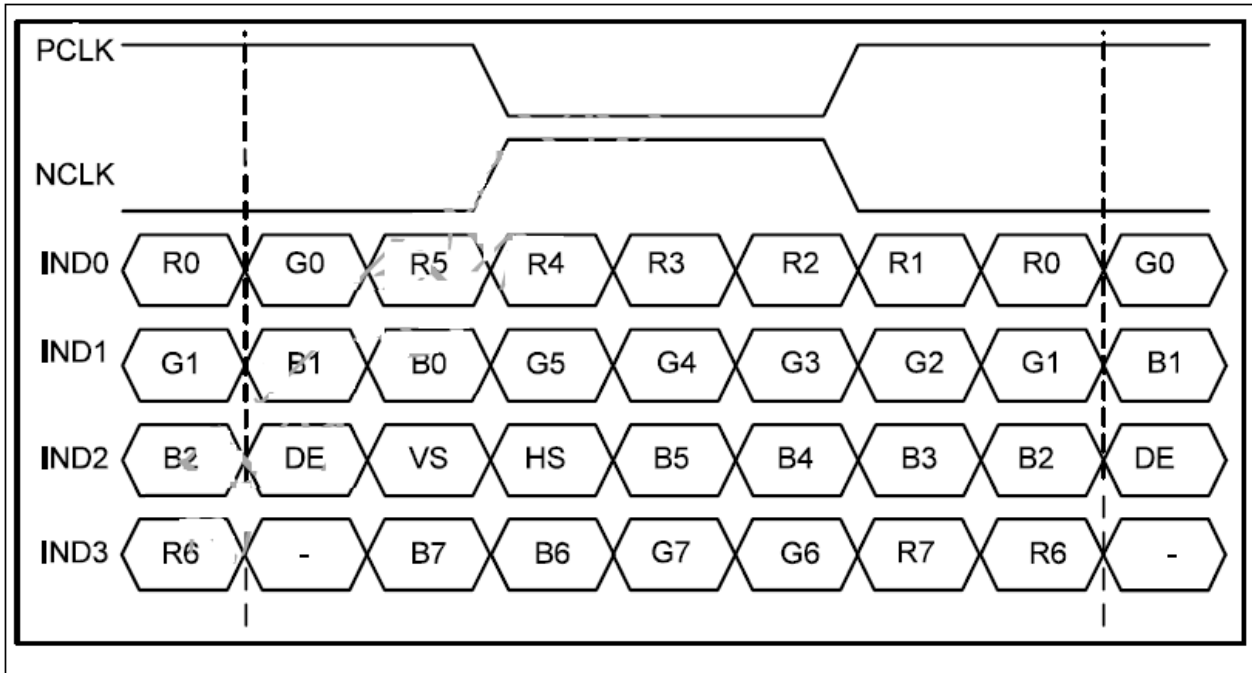

8-bit LVDS input timing chart

DEM 1024600G1 TMH-PW-N(A-TOUCH) Product Specification

8. Optical Characteristics

Item	Symbol	Condition.	Min	Typ.	Max.	Unit	Remark	
Response Time	Tr	$\theta=0^\circ, \phi=0^\circ$	-	25	40	.ms	Note 3	
	Tf							
Contrast Ratio	CR	At optimized viewing angle	600	800	-	-	Note 4	
Color Chromaticity	White	$\theta=0^\circ, \phi=0^\circ$	Wx	0.26	0.31	0.36	-	Note 2,5,6
			Wy	0.28	0.33	0.38	-	
Viewing Angle (Gray Scale Inversion Direction)	Hor.	ΘR	$CR \geq 10$	70	80	-	Deg.	Note 1
		ΘL		70	80	-		
	Ver.	ΦT		50	60	-		
		ΦB		60	70	-		
Brightness	-	-	350	400	-	cd/m ²	Center of display	
Uniformity	(U)	-	70	-	-	%	Note 5	

Ta=25°C ± 2°C,

Note 1: Definition of viewing angle range

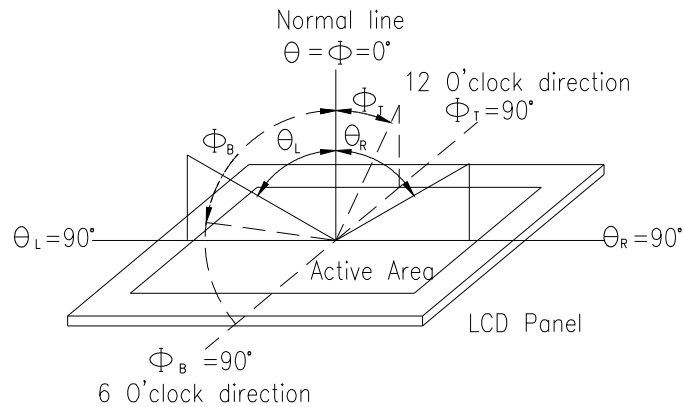

Fig. 9.1. Definition of viewing angle

Note 2: Test equipment setup:

After stabilizing and leaving the panel alone at a driven temperature for 10 minutes, the measurement should be executed. Measurement should be executed in a stable, windless, and dark room. Optical specifications are measured by Topcon BM-7 or BM-5 luminance meter 1.0° field of view at a distance of 50cm and normal direction.

DEM 1024600G1 TMH-PW-N(A-TOUCH) Product Specification

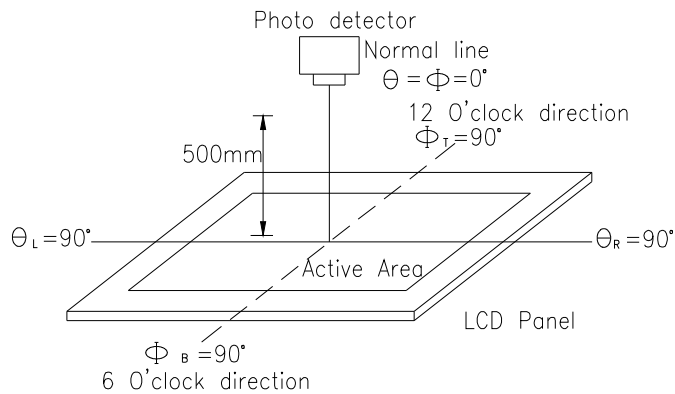
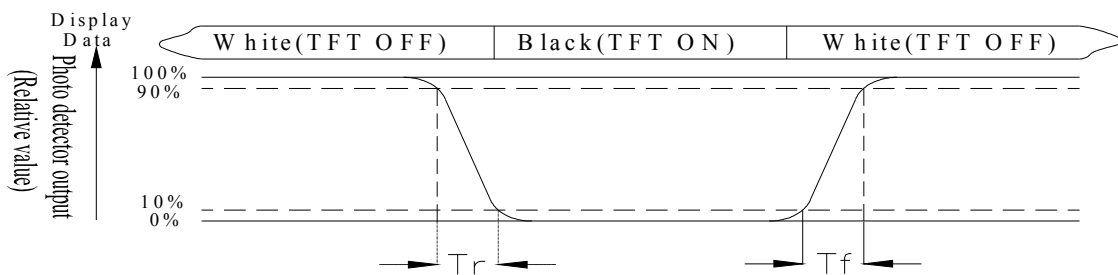

Fig. 9.2. Optical measurement system setup

Note 3: Definition of Response time:

The response time is defined as the LCD optical switching time interval between “White” state and “Black” state. Rise time, T_r , is the time between photo detector output intensity changed from 90% to 10%. And fall time, T_f , is the time between photo detector output intensity changed from 10% to 90%



Note 4: Definition of contrast ratio:

The contrast ratio is defined as the following expression.

$$\text{Contrast ratio (CR)} = \frac{\text{Luminance measured when LCD on the "White" state}}{\text{Luminance measured when LCD on the "Black" state}}$$

DEM 1024600G1 TMH-PW-N(A-TOUCH) Product Specification

Note 5: Definition of Luminance Uniformity

Active area is divided into 9 measuring areas (reference the picture in below). Every measuring point is placed at the center of each measuring area.

Luminance Uniformity (U) = $L_{min}/L_{max} \times 100\%$

L = Active area length

W = Active area width

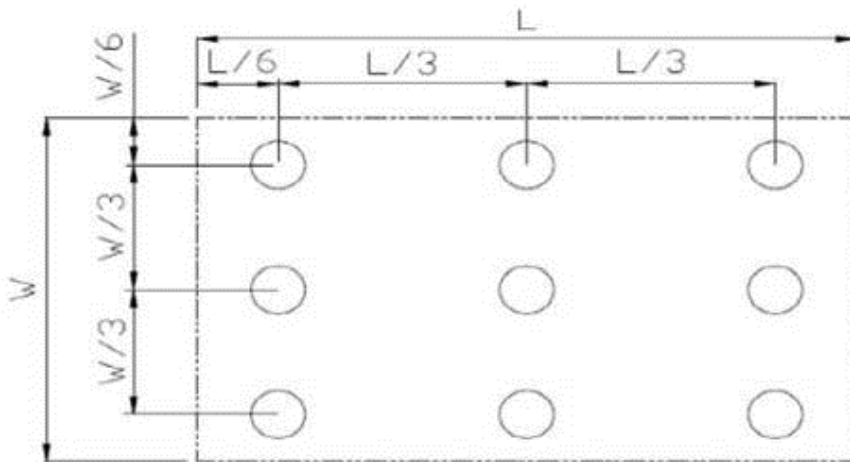

Fig9.3. Definition of uniformity

Note 6: Definition of color chromaticity (CIE 1931)

Color coordinates measured at the center point of LCD

Note 7: Measured at the center area of the panel when all the input terminals of LCD panel are electrically opened.

9. Reliability

Content of Reliability Test (Wide temperature, -20°C~70°C)

Environmental Test			
Test Item	Content of Test	Test Condition	Note
High Temperature storage	Endurance test applying the high storage temperature for a long time.	80□ 200hrs	2
Low Temperature storage	Endurance test applying the low storage temperature for a long time.	-30□ 200hrs	1,2
High Temperature Operation	Endurance test applying the electric stress (Voltage & Current) and the thermal stress to the element for a long time.	70□ 200hrs	—
Low Temperature Operation	Endurance test applying the electric stress under low temperature for a long time.	-20□ 200hrs	1
High Temperature/ Humidity Operation	The module should be allowed to stand at 60□,90%RH max	60□,90%RH 96hrs	1,2
Thermal shock resistance	The sample should be allowed stand the following 10 cycles of operation <div style="text-align: center;"> <p style="margin: 0;">-20□ 25□ 70□</p> <p style="margin: 0;">30min 5min 30min</p> <p style="margin: 0;">1 cycle</p> </div>	-20□/70□ 10 cycles	—
Vibration test	Endurance test applying the vibration during transportation and using.	Total fixed amplitude : 1.5mm Vibration Frequency : 10~55Hz One cycle 60 seconds to 3 directions of X,Y,Z for Each 15 minutes	3
Static electricity test	Endurance test applying the electric stress to the terminal.	VS=±600V(Contact), ±800V(Air), RS=330Ω CS=150pF 10 times	—

Note1: No dew condensation to be observed.

Note2: The function test shall be conducted after 4 hours storage at the normal Temperature and humidity after remove from the test chamber.

Note3: The packing have to including into the vibration testing.

10. Touch Panel Information

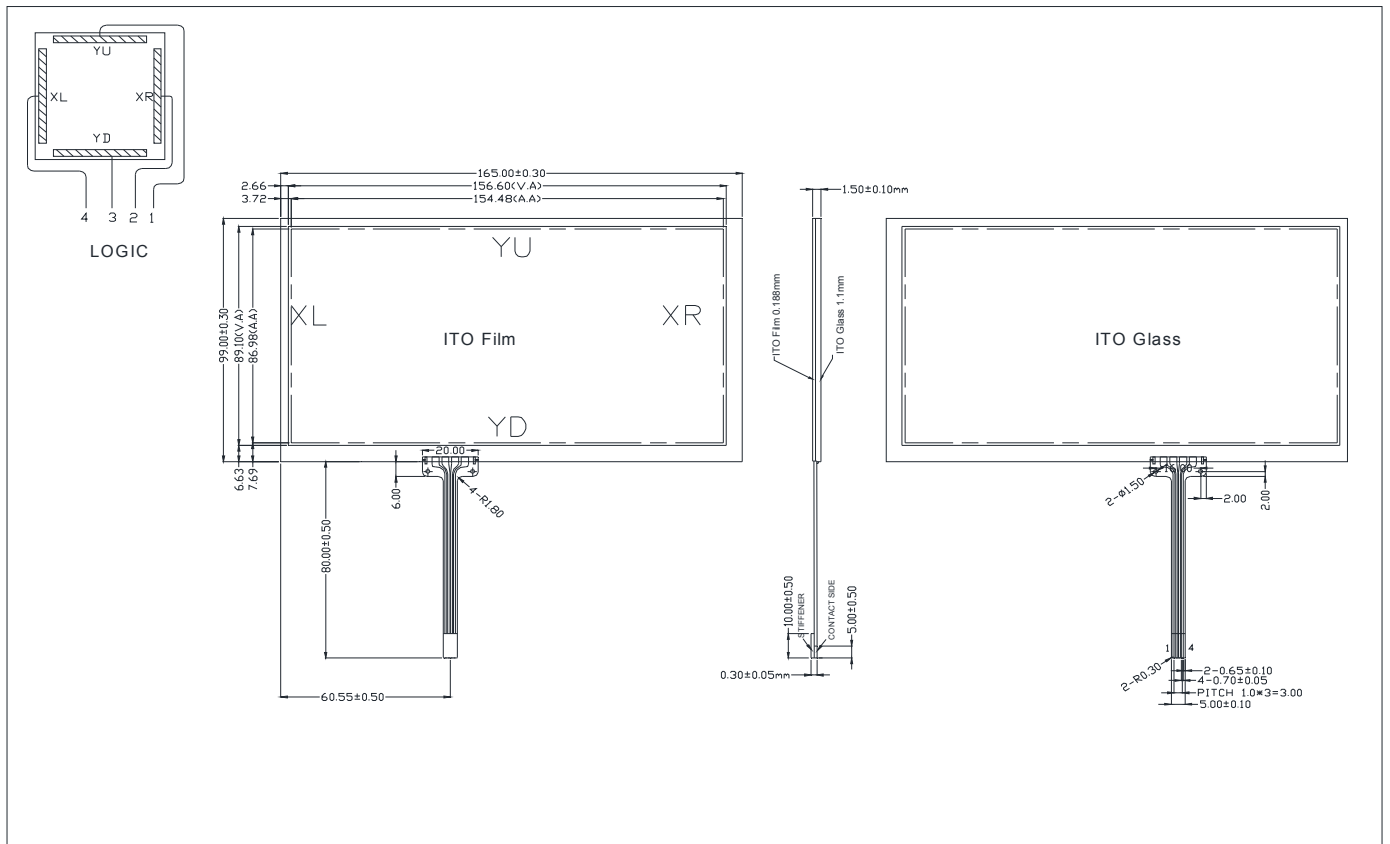

Resistance Touch Panel General Specifications

Item	Description
Driving Condition	DC3~7V
Operating Force	30~80g
Linearity max	$\leq \pm 1.5\%$
Insulating Resistance	$> 10M\Omega$, 25V(DC)
Light Transparence	70%
Structure Type	ITO Film/ITO Glass(F/G)
Surface Hardness	3H typ
Pen Hitting Durability (with the Silicon Rubber)	$> 1000,000$ times
X Axis Resistance	430~910 Ω
Y Axis Resistance	150~530 Ω