

Data sheet | Item number: 280-944/281-590

Component terminal block; double-deck; with end plate; with 1.5KE62C TVS diode; 48 VDC; for DIN-rail 35 x 15 and 35 x 7.5; 2.5 mm²; CAGE CLAMP®; 2,50 mm²; gray

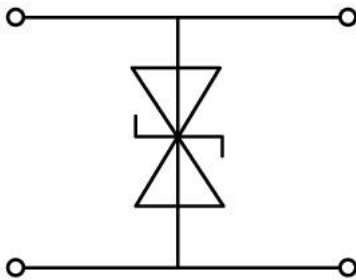

www.wago.com/280-944/281-590

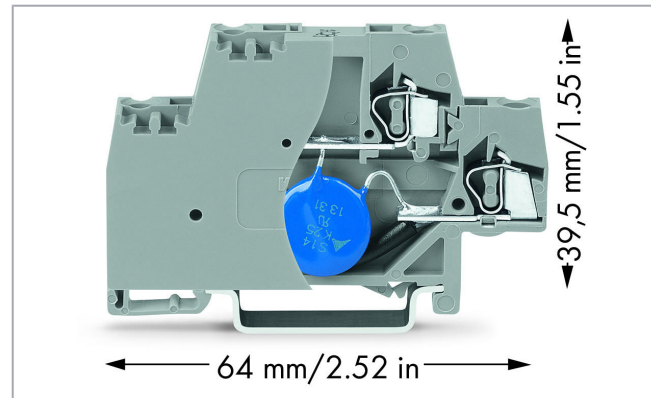
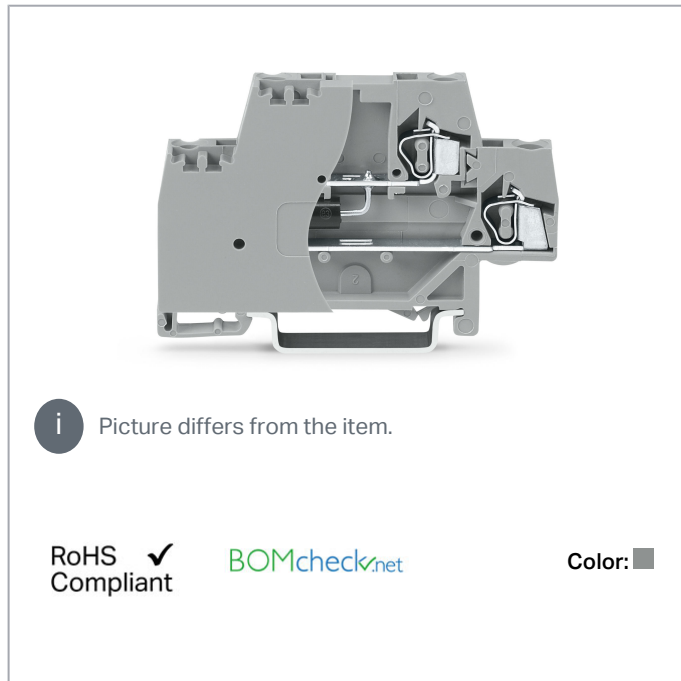

Item description

Short description:

This component terminal block with surge suppression device and end plate is equipped with a TVS diode.

Features:

- Protect your system against overvoltage
- Slim, space-saving design
- Control operational costs by preventing expensive, unplanned downtime

Subject to changes. Please also observe the further product documentation!

WAGO Kontakttechnik GmbH & Co. KG
Hansastr. 27
32423 Minden
Phone: +49571 887-0 | Fax: +49571 887-169
Email: info.de@wago.com | Web: www.wago.com

Do you have any questions about our products?
We are always happy to take your call at +49 (571) 887-44222.



- High operational reliability and system uptime

Data

Electrical data

Nominal operating voltage	DC 48 V
Continuous operating voltage (max.)	DC 53 V
Rated continuous current	20 A
Nominal discharge current (8/20 μ s), line	90 A
Protection level (8/20 μ s)	\leq DC 111 V
Capacitance	\leq 1.7 nF

Connection data

Connection points (number)	4
Connection technology	CAGE CLAMP®
Solid conductor	0.08 ... 2.5 mm ² / 28 ... 14 AWG
Fine-stranded conductor	0.08 ... 2.5 mm ² / 28 ... 14 AWG
Strip length	8 ... 9 mm / 0.31 ... 0.35 inch

Physical data

Width	10 mm / 0.394 inch
Height from upper-edge of DIN-rail	39.5 mm / 1.555 inch
Depth	64 mm / 2.52 inch

Mechanical data

Design	with end plate
Mounting type	DIN-35 rail

Material data

Color	gray
Fire load	0.271 MJ
Weight	14 g

Commercial data







Product Group	1 (Rail Mounted Terminal Blocks)
Packaging type	BOX

Subject to changes. Please also observe the further product documentation!



Country of origin	DE
GTIN	4050821515074
Customs tariff number	85369010000

Compatible products

Jumper

	Item no.: 280-482 Jumper; 2-way; insulated; gray	www.wago.com/280-482
	Item no.: 280-483 Jumper; 3-way; insulated; gray	www.wago.com/280-483
	Item no.: 280-484 Jumper; 4-way; insulated; gray	www.wago.com/280-484
	Item no.: 280-485 Jumper; 5-way; insulated; gray	www.wago.com/280-485
	Item no.: 280-490 Jumper; 10-way; insulated; gray	www.wago.com/280-490
	Item no.: 280-492 Jumper; 2-way; insulated; gray	www.wago.com/280-492



Insulation stop

	Item no.: 280-470 Insulation stop; 0.08 - 0.2 mm ² "s" (0.14 mm ² "f-st"); 5 pieces/strip; white	www.wago.com/280-470
	Item no.: 280-471 Insulation stop; 0.25 - 0.5 mm ² ; 5 pieces/strip; light gray	www.wago.com/280-471
	Item no.: 280-472 Insulation stop; 0.75 - 1 mm ² ; 5 pieces/strip	www.wago.com/280-472















tools

	Item no.: 210-720 Operating tool; Blade: 3.5 x 0.5 mm; with a partially insulated shaft; multicoloured	www.wago.com/210-720
--	--	--

Marking accessories

	Item no.: 2009-145 Mini-WSB Inline; for Smart Printer; 1700 pieces on roll; stretchable 5 - 5.2 mm; plain; snap-on type; white	www.wago.com/2009-145
	Item no.: 2009-145/000-002 Mini-WSB Inline; for Smart Printer; 1700 pieces on roll; stretchable 5 - 5.2 mm; plain; snap-on type; yellow	www.wago.com/2009-145/000-002
	Item no.: 2009-145/000-005 Mini-WSB Inline; for Smart Printer; 1700 pieces on roll; stretchable 5 - 5.2 mm; plain; snap-on type; red	www.wago.com/2009-145/000-005

Subject to changes. Please also observe the further product documentation!

	Item no.: 2009-145/000-006 Mini-WSB Inline; for Smart Printer; 1700 pieces on roll; stretchable 5 - 5.2 mm; plain; snap-on type; blue	www.wago.com/2009-145/000-006
	Item no.: 2009-145/000-007 Mini-WSB Inline; for Smart Printer; 1700 pieces on roll; stretchable 5 - 5.2 mm; plain; snap-on type; gray	www.wago.com/2009-145/000-007
	Item no.: 2009-145/000-012 Mini-WSB Inline; for Smart Printer; 1700 pieces on roll; stretchable 5 - 5.2 mm; plain; snap-on type; orange	www.wago.com/2009-145/000-012
	Item no.: 2009-145/000-023 Mini-WSB Inline; for Smart Printer; 1700 pieces on roll; stretchable 5 - 5.2 mm; plain; snap-on type; green	www.wago.com/2009-145/000-023
	Item no.: 2009-145/000-024 Mini-WSB Inline; for Smart Printer; 1700 pieces on roll; stretchable 5 - 5.2 mm; plain; snap-on type; violet	www.wago.com/2009-145/000-024
	Item no.: 248-501 Miniature WSB Quick marking system; plain; Marker width 5 mm; 10 strips with 10 markers per card	www.wago.com/248-501
	Item no.: 248-501/000-002 Mini-WSB marking card; as card; not stretchable; plain; snap-on type; yellow	www.wago.com/248-501/000-002
	Item no.: 248-501/000-005 Mini-WSB marking card; as card; not stretchable; plain; snap-on type; red	www.wago.com/248-501/000-005
	Item no.: 248-501/000-006 Mini-WSB marking card; as card; not stretchable; plain; snap-on type; blue	www.wago.com/248-501/000-006
	Item no.: 248-501/000-007 Mini-WSB marking card; as card; not stretchable; plain; snap-on type; gray	www.wago.com/248-501/000-007
	Item no.: 248-501/000-012 Mini-WSB marking card; as card; not stretchable; plain; snap-on type; orange	www.wago.com/248-501/000-012
	Item no.: 248-501/000-017 Mini-WSB marking card; as card; not stretchable; plain; snap-on type; light green	www.wago.com/248-501/000-017
	Item no.: 248-501/000-023 Mini-WSB marking card; as card; not stretchable; plain; snap-on type; green	www.wago.com/248-501/000-023
	Item no.: 248-501/000-024 Mini-WSB marking card; as card; not stretchable; plain; snap-on type; violet	www.wago.com/248-501/000-024

Subject to changes. Please also observe the further product documentation!



Downloads

Documentation

Bid Text

280-944/281-590 X81 - Datei	19. 2. 2019	xml 3.3 kB	Download
--------------------------------	-------------	---------------	----------

280-944/281-590 doc - Datei	11. 2. 2015	doc 26.1 kB	Download
--------------------------------	-------------	----------------	----------

Additional Information

Disposal; Electrical and electronic equipment, Packaging	V 1.0.0	pdf 265.8 kB	Download
--	---------	-----------------	----------

CAD/CAE-Data

CAE data

EPLAN Data Portal 280-944/281-590	URL	Download
-----------------------------------	-----	----------

WSCAD Universe 280-944/281-590	URL	Download
--------------------------------	-----	----------

EPLAN Data Portal 280-944/281-590	URL	Download
-----------------------------------	-----	----------

WSCAD Universe 280-944/281-590	URL	Download
--------------------------------	-----	----------

Environmental Product Compliance

Compliance Search

Environmental Product Compliance 280-944/281-590	URL	Download
--	-----	----------

Component terminal block; double-deck; with end plate; with 1.5KE62C TVS diode; 48 VDC; for DIN-rail 35 x 15 and 35 x 7.5; 2.5 mm²; CAGE CLAMP®; 2,50 mm²; gray

Installation Notes

Subject to changes. Please also observe the further product documentation!

WAGO Kontakttechnik GmbH & Co. KG
Hansastr. 27
32423 Minden
Phone: +49571 887-0 | Fax: +49571 887-169
Email: info.de@wago.com | Web: www.wago.com

Do you have any questions about our products?
We are always happy to take your call at +49 (571) 887-44222.