

4-Leiter-Initiatoreneinspeiseklemme; LED grün; mit PE-Anschluss; mit steckbarer Signalebene; 1 mm<sup>2</sup>; Push-in CAGE CLAMP®; 1,00 mm<sup>2</sup>; orange

[www.wago.com/2020-5477/1102-953](http://www.wago.com/2020-5477/1102-953)

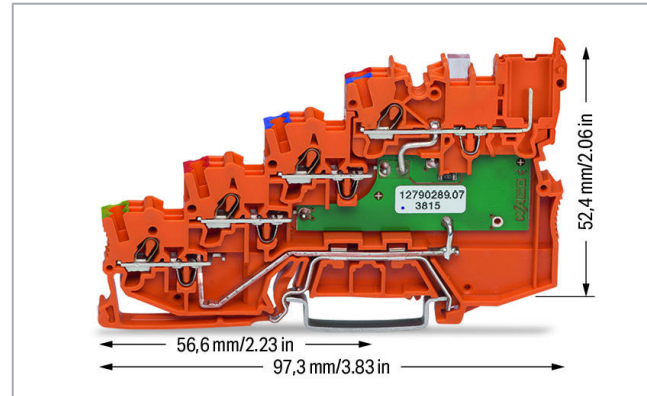
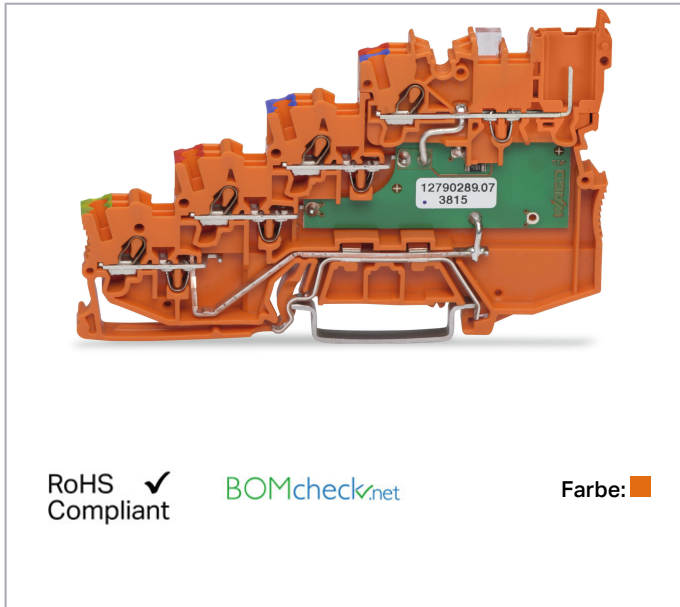

RoHS  Compliant

[BOMcheck.net](https://www.bomcheck.net)

Farbe: ■

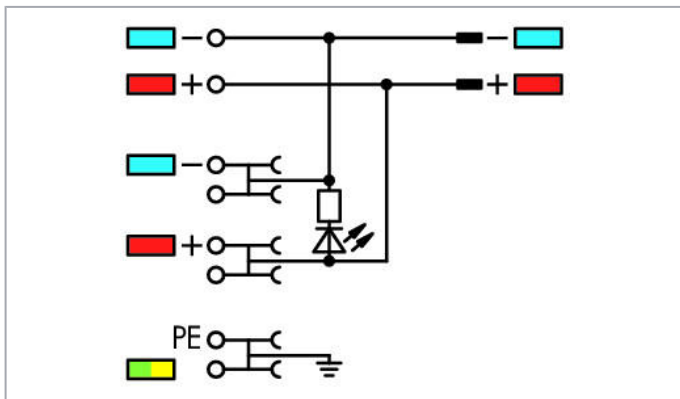

### Artikelbeschreibung

Teilungsbreite 3,5 mm pro Signal (2 x 3,5 mm = 7 mm)

Die doppelte Teilungsbreite dieser Klemmenfamilie ermöglicht das Anschließen von z. B. zehn Sensoren mit nur fünf Initiatorenklemmen zzgl. einer Einspeiseklemme.

Änderungen vorbehalten. Bitte beachten Sie auch die weitere Produktdokumentation!

WAGO Kontakttechnik GmbH & Co. KG  
Hansastr. 27  
32423 Minden  
Telefon: +49571 887-0 | Fax: +49571 887-169  
E-Mail: [info.de@wago.com](mailto:info.de@wago.com) | Web: [www.wago.com](http://www.wago.com)

Haben Sie Fragen zu unseren Produkten?  
Wir stehen Ihnen telefonisch unter +49 (571) 887-44222 gern zur Verfügung.

## Daten

### Elektrische Daten

Art der Spannung 1	DC
Nominalspannung	24 V

### Bemessungsdaten gemäß IEC/EN

Bemessungsstrom	13,5 A
Legende Bemessungsdaten	(III / 3) $\triangleq$ Überspannungskategorie III / Verschmutzungsgrad 3

### Bemessungsdaten gemäß UL

Approbationsdaten gemäß	UL 1059
Bemessungsspannung UL (Use Group B)	300 V
Bemessungsstrom UL (Use Group B)	15 A
Bemessungsspannung UL (Use Group D)	300 V
Bemessungsstrom UL (Use Group D)	15 A

### Bemessungsdaten gemäß CSA

Approbationsdaten gemäß	C22.2 No 158
Bemessungsspannung CSA (Use Group C)	24 V
Bemessungsstrom CSA (Use Group C)	10 A

### Anschlussdaten

Anschluss technik	Push-in CAGE CLAMP®
Betätigungsart	Push-in Betätigungswerkzeug
Anschließbare Leiterwerkstoffe	Kupfer
Nennquerschnitt	1 mm <sup>2</sup>
Eindrähtiger Leiter	0,14 ... 1,5 mm <sup>2</sup> / 24 ... 16 AWG
Eindrähtiger Leiter; direkt steckbar	0,5 ... 1,5 mm <sup>2</sup> / 20 ... 16 AWG
Feindrähtiger Leiter	0,14 ... 1,5 mm <sup>2</sup> / 24 ... 16 AWG
Feindrähtiger Leiter; mit Aderendhülse mit Kunststoffkragen	0,5 ... 0,75 mm <sup>2</sup> / 20 ... 18 AWG
Feindrähtiger Leiter; mit Aderendhülse, direkt steckbar	0,5 ... 0,75 mm <sup>2</sup> / 20 ... 18 AWG
Hinweis (Leiterquerschnitt)	Je nach Beschaffenheit des Leiters kann auch ein Leiter geringeren Querschnitts direkt steckbar sein.
Abisolierlänge	9 ... 11 mm / 0.35 ... 0.43 inch

Änderungen vorbehalten. Bitte beachten Sie auch die weitere Produktdokumentation!

WAGO Kontakttechnik GmbH & Co. KG  
Hansastr. 27  
32423 Minden  
Telefon: +49571 887-0 | Fax: +49571 887-169  
E-Mail: info.de@wago.com | Web: www.wago.com

Haben Sie Fragen zu unseren Produkten?  
Wir stehen Ihnen telefonisch unter +49 (571) 887-44222 gern zur Verfügung.



Gesamte Anzahl der Klemmstellen	8
Gesamte Anzahl der Potentiale	5
Anzahl der Ebenen	4
Verdrahtungsart	Frontverdrahtung
Anzahl Brückeraufnahmen	4

### Geometrische Daten

Breite	7 mm / 0.276 inch
Höhe	97,3 mm / 3.831 inch

### Mechanische Daten

Bauform	horizontale Bauform
Montageart	Tragschiene 35
Beschriftungsebene	Mitten-/Seitliche Beschriftung

### Werkstoffdaten

Farbe	orange
Isolierwerkstoff	Polyamid (PA66)
Brandlast	0,006 MJ
Gewicht	21,7 g

### Kaufmännische Daten

eCl@ss 10.0	27-14-11-28
eCl@ss 9.0	27-14-11-28
ETIM 7.0	EC000900
ETIM 6.0	EC000900
Verpackungsart	Karton
Ursprungsland	DE
GTIN	4055143525527
Zolltarifnummer	85369010000

### Zulassungen / Zertifikate

#### Länderspezifische Zulassungen

Logo	Zulassung	Norm	Zertifikatsname
	CCA DEKRA Certification B.V.	EN 60947	NTR NL 7617

Änderungen vorbehalten. Bitte beachten Sie auch die weitere Produktdokumentation!

WAGO Kontakttechnik GmbH & Co. KG  
 Hansastr. 27  
 32423 Minden  
 Telefon: +49571 887-0 | Fax: +49571 887-169  
 E-Mail: [info.de@wago.com](mailto:info.de@wago.com) | Web: [www.wago.com](http://www.wago.com)

Haben Sie Fragen zu unseren Produkten?  
 Wir stehen Ihnen telefonisch unter +49 (571) 887-44222 gern zur Verfügung.

CCA



CSA  
DEKRA Certification B.V.

C22.2 No. 158

2516073



KEMA/KEUR  
DEKRA Certification B.V.

EN 60947

71-100670

#### UL-Zulassungen

Logo	Zulassung	Norm	Zertifikatsname
	UL UL International Germany GmbH	UL 1059	20171023- E45172

#### Notwendiges Zubehör

##### Abschlussplatte



Art-Nr.: 2020-5491  
Abschluss- und Zwischenplatte; 1 mm dick; für 4-Leiter-Klemmen; grau

[www.wago.com/2020-5491](http://www.wago.com/2020-5491)

#### Passende Produkte

##### Aderendhülse



Art-Nr.: 216-241  
Aderendhülse; Hülse für 0,5 mm<sup>2</sup> / AWG 20; mit Kunststoffkragen; galvanisch verzinkt; Elektrolytkupfer; gasdicht aufgecrimpt; gemäß DIN 46228, Teil 4/09.90; weiß [www.wago.com/216-241](http://www.wago.com/216-241)



Art-Nr.: 216-242  
Aderendhülse; Hülse für 0,75 mm<sup>2</sup> / AWG 18; mit Kunststoffkragen; galvanisch verzinkt; Elektrolytkupfer; gasdicht aufgecrimpt; gemäß DIN 46228, Teil 4/09.90; grau [www.wago.com/216-242](http://www.wago.com/216-242)



Art-Nr.: 216-243  
Aderendhülse; Hülse für 1 mm<sup>2</sup> / AWG 18; mit Kunststoffkragen; galvanisch verzinkt; Elektrolytkupfer; gasdicht aufgecrimpt; gemäß DIN 46228, Teil 4/09.90; rot [www.wago.com/216-243](http://www.wago.com/216-243)

##### Brücker



Art-Nr.: 2000-402  
Brücker; 2-fach; isoliert; lichtgrau

[www.wago.com/2000-402](http://www.wago.com/2000-402)

















Art-Nr.: 2000-402/000-005  
Brücker; 2-fach; isoliert; rot

[www.wago.com/2000-402/000-005](http://www.wago.com/2000-402/000-005)

Änderungen vorbehalten. Bitte beachten Sie auch die weitere Produktdokumentation!

WAGO Kontakttechnik GmbH & Co. KG  
Hansastr. 27  
32423 Minden  
Telefon: +49571 887-0 | Fax: +49571 887-169  
E-Mail: [info.de@wago.com](mailto:info.de@wago.com) | Web: [www.wago.com](http://www.wago.com)

Haben Sie Fragen zu unseren Produkten?  
Wir stehen Ihnen telefonisch unter +49 (571) 887-44222 gern zur Verfügung.

	<b>Art-Nr.: 2000-402/000-006</b> Brücker; 2-fach; isoliert; blau	<a href="http://www.wago.com/2000-402/000-006">www.wago.com/2000-402/000-006</a>
	<b>Art-Nr.: 2000-402/000-018</b> Brücker; 2-fach; isoliert; gelbgrün	<a href="http://www.wago.com/2000-402/000-018">www.wago.com/2000-402/000-018</a>
	<b>Art-Nr.: 2000-403</b> Brücker; 3-fach; isoliert; lichtgrau	<a href="http://www.wago.com/2000-403">www.wago.com/2000-403</a>
	<b>Art-Nr.: 2000-403/000-005</b> Brücker; 3-fach; isoliert; rot	<a href="http://www.wago.com/2000-403/000-005">www.wago.com/2000-403/000-005</a>
	<b>Art-Nr.: 2000-403/000-006</b> Brücker; 3-fach; isoliert; blau	<a href="http://www.wago.com/2000-403/000-006">www.wago.com/2000-403/000-006</a>
	<b>Art-Nr.: 2000-404</b> Brücker; 4-fach; isoliert; lichtgrau	<a href="http://www.wago.com/2000-404">www.wago.com/2000-404</a>
	<b>Art-Nr.: 2000-404/000-005</b> Brücker; 4-fach; isoliert; rot	<a href="http://www.wago.com/2000-404/000-005">www.wago.com/2000-404/000-005</a>
	<b>Art-Nr.: 2000-404/000-006</b> Brücker; 4-fach; isoliert; blau	<a href="http://www.wago.com/2000-404/000-006">www.wago.com/2000-404/000-006</a>
	<b>Art-Nr.: 2000-405</b> Brücker; 5-fach; isoliert; lichtgrau	<a href="http://www.wago.com/2000-405">www.wago.com/2000-405</a>
	<b>Art-Nr.: 2000-405/000-005</b> Brücker; 5-fach; isoliert; rot	<a href="http://www.wago.com/2000-405/000-005">www.wago.com/2000-405/000-005</a>
	<b>Art-Nr.: 2000-405/000-006</b> Brücker; 5-fach; isoliert; blau	<a href="http://www.wago.com/2000-405/000-006">www.wago.com/2000-405/000-006</a>
	<b>Art-Nr.: 2000-405/011-000</b> Sternbrücker; 3-fach; isoliert; lichtgrau	<a href="http://www.wago.com/2000-405/011-000">www.wago.com/2000-405/011-000</a>
	<b>Art-Nr.: 2000-406</b> Brücker; 6-fach; isoliert; lichtgrau	<a href="http://www.wago.com/2000-406">www.wago.com/2000-406</a>
	<b>Art-Nr.: 2000-406/000-005</b> Brücker; 6-fach; isoliert; rot	<a href="http://www.wago.com/2000-406/000-005">www.wago.com/2000-406/000-005</a>

Änderungen vorbehalten. Bitte beachten Sie auch die weitere Produktdokumentation!

WAGO Kontakttechnik GmbH & Co. KG  
 Hansastr. 27  
 32423 Minden  
 Telefon: +49571 887-0 | Fax: +49571 887-169  
 E-Mail: [info.de@wago.com](mailto:info.de@wago.com) | Web: [www.wago.com](http://www.wago.com)

Haben Sie Fragen zu unseren Produkten?  
 Wir stehen Ihnen telefonisch unter +49 (571) 887-44222 gern zur Verfügung.



**Art-Nr.: 2000-406/000-006**  
Brücker; 6-fach; isoliert; blau

[www.wago.com/2000-406/000-006](http://www.wago.com/2000-406/000-006)



**Art-Nr.: 2000-406/020-000**  
Dreieckbrücker; isoliert; lichtgrau

[www.wago.com/2000-406/020-000](http://www.wago.com/2000-406/020-000)



**Art-Nr.: 2000-407**  
Brücker; 7-fach; isoliert; lichtgrau

[www.wago.com/2000-407](http://www.wago.com/2000-407)



**Art-Nr.: 2000-407/000-005**  
Brücker; 7-fach; isoliert; rot

[www.wago.com/2000-407/000-005](http://www.wago.com/2000-407/000-005)



**Art-Nr.: 2000-407/000-006**  
Brücker; 7-fach; isoliert; blau

[www.wago.com/2000-407/000-006](http://www.wago.com/2000-407/000-006)



**Art-Nr.: 2000-408**  
Brücker; 8-fach; isoliert; lichtgrau

[www.wago.com/2000-408](http://www.wago.com/2000-408)



**Art-Nr.: 2000-408/000-005**  
Brücker; 8-fach; isoliert; rot

[www.wago.com/2000-408/000-005](http://www.wago.com/2000-408/000-005)



**Art-Nr.: 2000-408/000-006**  
Brücker; 8-fach; isoliert; blau

[www.wago.com/2000-408/000-006](http://www.wago.com/2000-408/000-006)



**Art-Nr.: 2000-409**  
Brücker; 9-fach; isoliert; lichtgrau

[www.wago.com/2000-409](http://www.wago.com/2000-409)



**Art-Nr.: 2000-409/000-005**  
Brücker; 9-fach; isoliert; rot

[www.wago.com/2000-409/000-005](http://www.wago.com/2000-409/000-005)



**Art-Nr.: 2000-409/000-006**  
Brücker; 9-fach; isoliert; blau

[www.wago.com/2000-409/000-006](http://www.wago.com/2000-409/000-006)



**Art-Nr.: 2000-410**  
Brücker; 10-fach; isoliert; lichtgrau

[www.wago.com/2000-410](http://www.wago.com/2000-410)



**Art-Nr.: 2000-410/000-005**  
Brücker; 10-fach; isoliert; rot

[www.wago.com/2000-410/000-005](http://www.wago.com/2000-410/000-005)



**Art-Nr.: 2000-410/000-006**  
Brücker; 10-fach; isoliert; blau

[www.wago.com/2000-410/000-006](http://www.wago.com/2000-410/000-006)



















**Art-Nr.: 2000-433**  
Brücker; von 1 auf 3; isoliert; lichtgrau

[www.wago.com/2000-433](http://www.wago.com/2000-433)

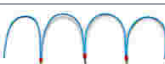
Änderungen vorbehalten. Bitte beachten Sie auch die weitere Produktdokumentation!

WAGO Kontakttechnik GmbH & Co. KG  
Hansastr. 27  
32423 Minden  
Telefon: +49571 887-0 | Fax: +49571 887-169  
E-Mail: [info.de@wago.com](mailto:info.de@wago.com) | Web: [www.wago.com](http://www.wago.com)

Haben Sie Fragen zu unseren Produkten?  
Wir stehen Ihnen telefonisch unter +49 (571) 887-44222 gern zur Verfügung.

	<b>Art-Nr.: 2000-433/000-005</b> Brücker; von 1 auf 3; isoliert; rot	<a href="http://www.wago.com/2000-433/000-005">www.wago.com/2000-433/000-005</a>
	<b>Art-Nr.: 2000-433/000-006</b> Brücker; von 1 auf 3; isoliert; blau	<a href="http://www.wago.com/2000-433/000-006">www.wago.com/2000-433/000-006</a>
	<b>Art-Nr.: 2000-434</b> Brücker; von 1 auf 4; isoliert; lichtgrau	<a href="http://www.wago.com/2000-434">www.wago.com/2000-434</a>
	<b>Art-Nr.: 2000-435</b> Brücker; von 1 auf 5; isoliert; lichtgrau	<a href="http://www.wago.com/2000-435">www.wago.com/2000-435</a>
	<b>Art-Nr.: 2000-436</b> Brücker; von 1 auf 6; isoliert; lichtgrau	<a href="http://www.wago.com/2000-436">www.wago.com/2000-436</a>
	<b>Art-Nr.: 2000-437</b> Brücker; von 1 auf 7; isoliert; lichtgrau	<a href="http://www.wago.com/2000-437">www.wago.com/2000-437</a>
	<b>Art-Nr.: 2000-438</b> Brücker; von 1 auf 8; isoliert; lichtgrau	<a href="http://www.wago.com/2000-438">www.wago.com/2000-438</a>
	<b>Art-Nr.: 2000-439</b> Brücker; von 1 auf 9; isoliert; lichtgrau	<a href="http://www.wago.com/2000-439">www.wago.com/2000-439</a>
	<b>Art-Nr.: 2000-440</b> Brücker; von 1 auf 10; isoliert; lichtgrau	<a href="http://www.wago.com/2000-440">www.wago.com/2000-440</a>
	<b>Art-Nr.: 210-103</b> Drahtkettenbrücker; isoliert; schwarz	<a href="http://www.wago.com/210-103">www.wago.com/210-103</a>
	<b>Art-Nr.: 210-123</b> Drahtkettenbrücker; isoliert; blau	<a href="http://www.wago.com/210-123">www.wago.com/210-123</a>
<b>Werkzeug</b>		
	<b>Art-Nr.: 210-647</b> Betätigungswerkzeug; Klinge 2,5 x 0,4 mm; mit teilisoliertem Schaft; mehrfarbig	<a href="http://www.wago.com/210-647">www.wago.com/210-647</a>
	<b>Art-Nr.: 210-648</b> Betätigungswerkzeug; Klinge 2,5 x 0,4 mm; mit teilisoliertem Schaft; abgewinkelt; kurz	<a href="http://www.wago.com/210-648">www.wago.com/210-648</a>
	<b>Art-Nr.: 210-719</b> Betätigungswerkzeug; Klinge 2,5 x 0,4 mm; mit teilisoliertem Schaft	<a href="http://www.wago.com/210-719">www.wago.com/210-719</a>
<b>Steckbarer Leitungsbrücker</b>		
	<b>Art-Nr.: 2009-402</b> Steckbarer Leitungsbrücker; 0,75 mm <sup>2</sup> ; isoliert; 60 mm lang; grau	<a href="http://www.wago.com/2009-402">www.wago.com/2009-402</a>
	<b>Art-Nr.: 2009-404</b> Steckbarer Leitungsbrücker; 0,75 mm <sup>2</sup> ; isoliert; 110 mm lang; grau	<a href="http://www.wago.com/2009-404">www.wago.com/2009-404</a>

Änderungen vorbehalten. Bitte beachten Sie auch die weitere Produktdokumentation!



**Art-Nr.: 2009-406**  
Steckbarer Leitungsbrücker; 0,75 mm<sup>2</sup>; isoliert; 250 mm lang; grau

[www.wago.com/2009-406](http://www.wago.com/2009-406)

#### Kodierung



**Art-Nr.: 2020-100**  
Träger mit 6 Kodierstiften; zur Kodierung der Federleisten; für Basisklemmen; orange

[www.wago.com/2020-100](http://www.wago.com/2020-100)

#### Prüfen und Messen



**Art-Nr.: 2000-510**  
TOPJOB®S-L-Prüfsteckermodul; anreihbar; für Brückerschlitze; 1,00 mm<sup>2</sup>; grau

[www.wago.com/2000-510](http://www.wago.com/2000-510)



**Art-Nr.: 2000-552**  
Modularer TOPJOB®S-Steckverbinder; anreihbar; für Brückerschlitze; 2-polig; 1,00 mm<sup>2</sup>; grau

[www.wago.com/2000-552](http://www.wago.com/2000-552)



**Art-Nr.: 2000-553**  
Modularer TOPJOB®S-Steckverbinder; anreihbar; für Brückerschlitze; 3-polig; 1,00 mm<sup>2</sup>; grau

[www.wago.com/2000-553](http://www.wago.com/2000-553)



**Art-Nr.: 2000-554**  
Modularer TOPJOB®S-Steckverbinder; anreihbar; für Brückerschlitze; 4-polig; 1,00 mm<sup>2</sup>; grau

[www.wago.com/2000-554](http://www.wago.com/2000-554)



**Art-Nr.: 2000-555**  
Modularer TOPJOB®S-Steckverbinder; anreihbar; für Brückerschlitze; 5-polig; 1,00 mm<sup>2</sup>; grau

[www.wago.com/2000-555](http://www.wago.com/2000-555)



**Art-Nr.: 2000-556**  
Modularer TOPJOB®S-Steckverbinder; anreihbar; für Brückerschlitze; 6-polig; 1,00 mm<sup>2</sup>; grau

[www.wago.com/2000-556](http://www.wago.com/2000-556)



**Art-Nr.: 2000-557**  
Modularer TOPJOB®S-Steckverbinder; anreihbar; für Brückerschlitze; 7-polig; 1,00 mm<sup>2</sup>; grau

[www.wago.com/2000-557](http://www.wago.com/2000-557)



**Art-Nr.: 2000-558**  
Modularer TOPJOB®S-Steckverbinder; anreihbar; für Brückerschlitze; 8-polig; 1,00 mm<sup>2</sup>; grau

[www.wago.com/2000-558](http://www.wago.com/2000-558)



**Art-Nr.: 2000-559**  
Modularer TOPJOB®S-Steckverbinder; anreihbar; für Brückerschlitze; 9-polig; 1,00 mm<sup>2</sup>; grau

[www.wago.com/2000-559](http://www.wago.com/2000-559)



**Art-Nr.: 2000-560**  
Modularer TOPJOB®S-Steckverbinder; anreihbar; für Brückerschlitze; 10-polig; 1,00 mm<sup>2</sup>; grau

[www.wago.com/2000-560](http://www.wago.com/2000-560)



**Art-Nr.: 2009-174**  
Prüfadapter; für Prüfstecker Ø 4 mm; zur Prüfung von TOPJOB®S-Reihenklemmen; grau

[www.wago.com/2009-174](http://www.wago.com/2009-174)



**Art-Nr.: 2009-182**  
Prüfabgriff; für max. 2,5 mm<sup>2</sup>; für den werkzeuglosen Anschluss individueller Prüfleitungen von 0,08 mm - 2,5 mm; grau

[www.wago.com/2009-182](http://www.wago.com/2009-182)

#### Warnabdeckung



**Art-Nr.: 2000-115**  
Warnabdeckung; mit schwarzem Blitzpfeil; für 5 Klemmen; gelb

[www.wago.com/2000-115](http://www.wago.com/2000-115)

#### Federleiste



**Art-Nr.: 2020-102**  
1-Leiter-Federleiste; 1,5 mm<sup>2</sup>; 2-polig; 1,50 mm<sup>2</sup>; grau

[www.wago.com/2020-102](http://www.wago.com/2020-102)

Änderungen vorbehalten. Bitte beachten Sie auch die weitere Produktdokumentation!



**Art-Nr.: 2020-102/122-000**

1-Leiter-Federleiste; Verriegelungsklinke; 1,5 mm<sup>2</sup>; 2-polig; 1,50 mm<sup>2</sup>; grau

[www.wago.com/2020-102/122-000](http://www.wago.com/2020-102/122-000)

**Art-Nr.: 2020-102/132-000**

1-Leiter-Federleiste; Zugentlastungsplatte; 1,5 mm<sup>2</sup>; 2-polig; 1,50 mm<sup>2</sup>; grau

[www.wago.com/2020-102/132-000](http://www.wago.com/2020-102/132-000)

**Art-Nr.: 2020-102/142-000**

1-Leiter-Federleiste; Zugentlastungsplatte; 1,5 mm<sup>2</sup>; 2-polig; 1,50 mm<sup>2</sup>; grau

[www.wago.com/2020-102/142-000](http://www.wago.com/2020-102/142-000)



**Art-Nr.: 2020-103**

1-Leiter-Federleiste; 1,5 mm<sup>2</sup>; 3-polig; 1,50 mm<sup>2</sup>; grau

[www.wago.com/2020-103](http://www.wago.com/2020-103)



**Art-Nr.: 2020-103/000-036**

1-Leiter-Federleiste; 1,5 mm<sup>2</sup>; 3-polig; 1,50 mm<sup>2</sup>; grau/gr-ge

[www.wago.com/2020-103/000-036](http://www.wago.com/2020-103/000-036)



**Art-Nr.: 2020-103/000-037**

1-Leiter-Federleiste; 1,5 mm<sup>2</sup>; 3-polig; 1,50 mm<sup>2</sup>; gr-ge/grau

[www.wago.com/2020-103/000-037](http://www.wago.com/2020-103/000-037)



**Art-Nr.: 2020-103/000-038**

1-Leiter-Federleiste; 1,5 mm<sup>2</sup>; 3-polig; 1,50 mm<sup>2</sup>; grau/blau/gr-ge

[www.wago.com/2020-103/000-038](http://www.wago.com/2020-103/000-038)



**Art-Nr.: 2020-103/000-039**

1-Leiter-Federleiste; 1,5 mm<sup>2</sup>; 3-polig; 1,50 mm<sup>2</sup>; gr-ge./blau/grau

[www.wago.com/2020-103/000-039](http://www.wago.com/2020-103/000-039)

**Art-Nr.: 2020-103/122-000**

1-Leiter-Federleiste; Verriegelungsklinke; 1,5 mm<sup>2</sup>; 3-polig; 1,50 mm<sup>2</sup>; grau

[www.wago.com/2020-103/122-000](http://www.wago.com/2020-103/122-000)

**Art-Nr.: 2020-103/132-000**

1-Leiter-Federleiste; Zugentlastungsplatte; 1,5 mm<sup>2</sup>; 3-polig; 1,50 mm<sup>2</sup>; grau

[www.wago.com/2020-103/132-000](http://www.wago.com/2020-103/132-000)

**Art-Nr.: 2020-103/142-000**

1-Leiter-Federleiste; Zugentlastungsplatte; 1,5 mm<sup>2</sup>; 3-polig; 1,50 mm<sup>2</sup>; grau

[www.wago.com/2020-103/142-000](http://www.wago.com/2020-103/142-000)



**Art-Nr.: 2020-104**

1-Leiter-Federleiste; 1,5 mm<sup>2</sup>; 4-polig; 1,50 mm<sup>2</sup>; grau

[www.wago.com/2020-104](http://www.wago.com/2020-104)



**Art-Nr.: 2020-104/000-036**

1-Leiter-Federleiste; 1,5 mm<sup>2</sup>; 4-polig; 1,50 mm<sup>2</sup>; grau/gr-ge

[www.wago.com/2020-104/000-036](http://www.wago.com/2020-104/000-036)



**Art-Nr.: 2020-104/000-037**

1-Leiter-Federleiste; 1,5 mm<sup>2</sup>; 4-polig; 1,50 mm<sup>2</sup>; gr-ge/grau

[www.wago.com/2020-104/000-037](http://www.wago.com/2020-104/000-037)

Änderungen vorbehalten. Bitte beachten Sie auch die weitere Produktdokumentation!

WAGO Kontakttechnik GmbH & Co. KG

Hansastr. 27

32423 Minden

Telefon: +49571 887-0 | Fax: +49571 887-169

E-Mail: [info.de@wago.com](mailto:info.de@wago.com) | Web: [www.wago.com](http://www.wago.com)

Haben Sie Fragen zu unseren Produkten?

Wir stehen Ihnen telefonisch unter +49 (571) 887-44222 gern zur Verfügung.



**Art-Nr.: 2020-104/000-038**  
1-Leiter-Federleiste; 1,5 mm<sup>2</sup>; 4-polig; 1,50 mm<sup>2</sup>; grau/blau/gr-ge

[www.wago.com/2020-104/000-038](http://www.wago.com/2020-104/000-038)



**Art-Nr.: 2020-104/000-039**  
1-Leiter-Federleiste; 1,5 mm<sup>2</sup>; 4-polig; 1,50 mm<sup>2</sup>; gr-ge./blau/grau

[www.wago.com/2020-104/000-039](http://www.wago.com/2020-104/000-039)

**Art-Nr.: 2020-104/124-000**  
1-Leiter-Federleiste; Verriegelungsklinke; 1,5 mm<sup>2</sup>; 4-polig; 1,50 mm<sup>2</sup>; grau

[www.wago.com/2020-104/124-000](http://www.wago.com/2020-104/124-000)

**Art-Nr.: 2020-104/133-000**  
1-Leiter-Federleiste; Zugentlastungsplatte; 1,5 mm<sup>2</sup>; 4-polig; 1,50 mm<sup>2</sup>; grau

[www.wago.com/2020-104/133-000](http://www.wago.com/2020-104/133-000)

**Art-Nr.: 2020-104/143-000**  
1-Leiter-Federleiste; Zugentlastungsplatte; 1,5 mm<sup>2</sup>; 4-polig; 1,50 mm<sup>2</sup>; grau

[www.wago.com/2020-104/143-000](http://www.wago.com/2020-104/143-000)



**Art-Nr.: 2020-105**  
1-Leiter-Federleiste; 1,5 mm<sup>2</sup>; 5-polig; 1,50 mm<sup>2</sup>; grau

[www.wago.com/2020-105](http://www.wago.com/2020-105)



**Art-Nr.: 2020-105/000-036**  
1-Leiter-Federleiste; 1,5 mm<sup>2</sup>; 5-polig; 1,50 mm<sup>2</sup>; grau/gr-ge

[www.wago.com/2020-105/000-036](http://www.wago.com/2020-105/000-036)



**Art-Nr.: 2020-105/000-037**  
1-Leiter-Federleiste; 1,5 mm<sup>2</sup>; 5-polig; 1,50 mm<sup>2</sup>; gr-ge/grau

[www.wago.com/2020-105/000-037](http://www.wago.com/2020-105/000-037)



**Art-Nr.: 2020-105/000-038**  
1-Leiter-Federleiste; 1,5 mm<sup>2</sup>; 5-polig; 1,50 mm<sup>2</sup>; grau/blau/gr-ge

[www.wago.com/2020-105/000-038](http://www.wago.com/2020-105/000-038)



**Art-Nr.: 2020-105/000-039**  
1-Leiter-Federleiste; 1,5 mm<sup>2</sup>; 5-polig; 1,50 mm<sup>2</sup>; gr-ge./blau/grau

[www.wago.com/2020-105/000-039](http://www.wago.com/2020-105/000-039)



**Art-Nr.: 2020-105/124-000**  
1-Leiter-Federleiste; Verriegelungsklinke; 1,5 mm<sup>2</sup>; 5-polig; 1,50 mm<sup>2</sup>; grau

[www.wago.com/2020-105/124-000](http://www.wago.com/2020-105/124-000)



**Art-Nr.: 2020-105/133-000**  
1-Leiter-Federleiste; Zugentlastungsplatte; 1,5 mm<sup>2</sup>; 5-polig; 1,50 mm<sup>2</sup>; grau

[www.wago.com/2020-105/133-000](http://www.wago.com/2020-105/133-000)



**Art-Nr.: 2020-105/143-000**  
1-Leiter-Federleiste; Zugentlastungsplatte; 1,5 mm<sup>2</sup>; 5-polig; 1,50 mm<sup>2</sup>; grau

[www.wago.com/2020-105/143-000](http://www.wago.com/2020-105/143-000)



**Art-Nr.: 2020-106**  
1-Leiter-Federleiste; 1,5 mm<sup>2</sup>; 6-polig; 1,50 mm<sup>2</sup>; grau

[www.wago.com/2020-106](http://www.wago.com/2020-106)

Änderungen vorbehalten. Bitte beachten Sie auch die weitere Produktdokumentation!



**Art-Nr.: 2020-106/000-036**  
1-Leiter-Federleiste; 1,5 mm<sup>2</sup>; 6-polig; 1,50 mm<sup>2</sup>; grau/gr-ge

[www.wago.com/2020-106/000-036](http://www.wago.com/2020-106/000-036)



**Art-Nr.: 2020-106/000-037**  
1-Leiter-Federleiste; 1,5 mm<sup>2</sup>; 6-polig; 1,50 mm<sup>2</sup>; gr-ge/grau

[www.wago.com/2020-106/000-037](http://www.wago.com/2020-106/000-037)



**Art-Nr.: 2020-106/000-038**  
1-Leiter-Federleiste; 1,5 mm<sup>2</sup>; 6-polig; 1,50 mm<sup>2</sup>; grau/blau/gr-ge

[www.wago.com/2020-106/000-038](http://www.wago.com/2020-106/000-038)



**Art-Nr.: 2020-106/000-039**  
1-Leiter-Federleiste; 1,5 mm<sup>2</sup>; 6-polig; 1,50 mm<sup>2</sup>; gr-ge/blau/grau

[www.wago.com/2020-106/000-039](http://www.wago.com/2020-106/000-039)

**Art-Nr.: 2020-106/124-000**  
1-Leiter-Federleiste; Verriegelungsklinke; 1,5 mm<sup>2</sup>; 6-polig; 1,50 mm<sup>2</sup>; grau

[www.wago.com/2020-106/124-000](http://www.wago.com/2020-106/124-000)

**Art-Nr.: 2020-106/133-000**  
1-Leiter-Federleiste; Zugentlastungsplatte; 1,5 mm<sup>2</sup>; 6-polig; 1,50 mm<sup>2</sup>; grau

[www.wago.com/2020-106/133-000](http://www.wago.com/2020-106/133-000)

**Art-Nr.: 2020-106/143-000**  
1-Leiter-Federleiste; Zugentlastungsplatte; 1,5 mm<sup>2</sup>; 6-polig; 1,50 mm<sup>2</sup>; grau

[www.wago.com/2020-106/143-000](http://www.wago.com/2020-106/143-000)



**Art-Nr.: 2020-107**  
1-Leiter-Federleiste; 1,5 mm<sup>2</sup>; 7-polig; 1,50 mm<sup>2</sup>; grau

[www.wago.com/2020-107](http://www.wago.com/2020-107)



**Art-Nr.: 2020-107/000-036**  
1-Leiter-Federleiste; 1,5 mm<sup>2</sup>; 7-polig; 1,50 mm<sup>2</sup>; grau/gr-ge

[www.wago.com/2020-107/000-036](http://www.wago.com/2020-107/000-036)



**Art-Nr.: 2020-107/000-037**  
1-Leiter-Federleiste; 1,5 mm<sup>2</sup>; 7-polig; 1,50 mm<sup>2</sup>; gr-ge/grau

[www.wago.com/2020-107/000-037](http://www.wago.com/2020-107/000-037)



**Art-Nr.: 2020-107/000-038**  
1-Leiter-Federleiste; 1,5 mm<sup>2</sup>; 7-polig; 1,50 mm<sup>2</sup>; grau/blau/gr-ge

[www.wago.com/2020-107/000-038](http://www.wago.com/2020-107/000-038)



**Art-Nr.: 2020-107/000-039**  
1-Leiter-Federleiste; 1,5 mm<sup>2</sup>; 7-polig; 1,50 mm<sup>2</sup>; gr-ge/blau/grau

[www.wago.com/2020-107/000-039](http://www.wago.com/2020-107/000-039)











**Art-Nr.: 2020-107/124-000**  
1-Leiter-Federleiste; Verriegelungsklinke; 1,5 mm<sup>2</sup>; 7-polig; 1,50 mm<sup>2</sup>; grau

[www.wago.com/2020-107/124-000](http://www.wago.com/2020-107/124-000)









**Art-Nr.: 2020-107/134-000**  
1-Leiter-Federleiste; Zugentlastungsplatte; 1,5 mm<sup>2</sup>; 7-polig; 1,50 mm<sup>2</sup>; grau

[www.wago.com/2020-107/134-000](http://www.wago.com/2020-107/134-000)

Änderungen vorbehalten. Bitte beachten Sie auch die weitere Produktdokumentation!

	<b>Art-Nr.: 2020-107/144-000</b> 1-Leiter-Federleiste; Zugentlastungsplatte; 1,5 mm <sup>2</sup> ; 7-polig; 1,50 mm <sup>2</sup> ; grau	<a href="http://www.wago.com/2020-107/144-000">www.wago.com/2020-107/144-000</a>
	<b>Art-Nr.: 2020-108</b> 1-Leiter-Federleiste; 1,5 mm <sup>2</sup> ; 8-polig; 1,50 mm <sup>2</sup> ; grau	<a href="http://www.wago.com/2020-108">www.wago.com/2020-108</a>
	<b>Art-Nr.: 2020-108/000-036</b> 1-Leiter-Federleiste; 1,5 mm <sup>2</sup> ; 8-polig; 1,50 mm <sup>2</sup> ; grau/gr-ge	<a href="http://www.wago.com/2020-108/000-036">www.wago.com/2020-108/000-036</a>
	<b>Art-Nr.: 2020-108/000-037</b> 1-Leiter-Federleiste; 1,5 mm <sup>2</sup> ; 8-polig; 1,50 mm <sup>2</sup> ; gr-ge/grau	<a href="http://www.wago.com/2020-108/000-037">www.wago.com/2020-108/000-037</a>
	<b>Art-Nr.: 2020-108/000-038</b> 1-Leiter-Federleiste; 1,5 mm <sup>2</sup> ; 8-polig; 1,50 mm <sup>2</sup> ; grau/blau/gr-ge	<a href="http://www.wago.com/2020-108/000-038">www.wago.com/2020-108/000-038</a>
	<b>Art-Nr.: 2020-108/000-039</b> 1-Leiter-Federleiste; 1,5 mm <sup>2</sup> ; 8-polig; 1,50 mm <sup>2</sup> ; gr-ge./blau/grau	<a href="http://www.wago.com/2020-108/000-039">www.wago.com/2020-108/000-039</a>
	<b>Art-Nr.: 2020-108/124-000</b> 1-Leiter-Federleiste; Verriegelungsklinke; 1,5 mm <sup>2</sup> ; 8-polig; 1,50 mm <sup>2</sup> ; grau	<a href="http://www.wago.com/2020-108/124-000">www.wago.com/2020-108/124-000</a>
	<b>Art-Nr.: 2020-108/134-000</b> 1-Leiter-Federleiste; Zugentlastungsplatte; 1,5 mm <sup>2</sup> ; 8-polig; 1,50 mm <sup>2</sup> ; grau	<a href="http://www.wago.com/2020-108/134-000">www.wago.com/2020-108/134-000</a>
	<b>Art-Nr.: 2020-108/144-000</b> 1-Leiter-Federleiste; Zugentlastungsplatte; 1,5 mm <sup>2</sup> ; 8-polig; 1,50 mm <sup>2</sup> ; grau	<a href="http://www.wago.com/2020-108/144-000">www.wago.com/2020-108/144-000</a>
	<b>Art-Nr.: 2020-109</b> 1-Leiter-Federleiste; 1,5 mm <sup>2</sup> ; 9-polig; 1,50 mm <sup>2</sup> ; grau	<a href="http://www.wago.com/2020-109">www.wago.com/2020-109</a>
	<b>Art-Nr.: 2020-109/000-036</b> 1-Leiter-Federleiste; 1,5 mm <sup>2</sup> ; 9-polig; 1,50 mm <sup>2</sup> ; grau/gr-ge	<a href="http://www.wago.com/2020-109/000-036">www.wago.com/2020-109/000-036</a>
	<b>Art-Nr.: 2020-109/000-037</b> 1-Leiter-Federleiste; 1,5 mm <sup>2</sup> ; 9-polig; 1,50 mm <sup>2</sup> ; gr-ge/grau	<a href="http://www.wago.com/2020-109/000-037">www.wago.com/2020-109/000-037</a>
	<b>Art-Nr.: 2020-109/000-038</b> 1-Leiter-Federleiste; 1,5 mm <sup>2</sup> ; 9-polig; 1,50 mm <sup>2</sup> ; grau/blau/gr-ge	<a href="http://www.wago.com/2020-109/000-038">www.wago.com/2020-109/000-038</a>
	<b>Art-Nr.: 2020-109/000-039</b> 1-Leiter-Federleiste; 1,5 mm <sup>2</sup> ; 9-polig; 1,50 mm <sup>2</sup> ; gr-ge./blau/grau	<a href="http://www.wago.com/2020-109/000-039">www.wago.com/2020-109/000-039</a>









Änderungen vorbehalten. Bitte beachten Sie auch die weitere Produktdokumentation!

	<b>Art-Nr.: 2020-109/124-000</b> 1-Leiter-Federleiste; Verriegelungsklinke; 1,5 mm <sup>2</sup> ; 9-polig; 1,50 mm <sup>2</sup> ; grau	<a href="http://www.wago.com/2020-109/124-000">www.wago.com/2020-109/124-000</a>
	<b>Art-Nr.: 2020-109/134-000</b> 1-Leiter-Federleiste; Zugentlastungsplatte; 1,5 mm <sup>2</sup> ; 9-polig; 1,50 mm <sup>2</sup> ; grau	<a href="http://www.wago.com/2020-109/134-000">www.wago.com/2020-109/134-000</a>
	<b>Art-Nr.: 2020-109/144-000</b> 1-Leiter-Federleiste; Zugentlastungsplatte; 1,5 mm <sup>2</sup> ; 9-polig; 1,50 mm <sup>2</sup> ; grau	<a href="http://www.wago.com/2020-109/144-000">www.wago.com/2020-109/144-000</a>
	<b>Art-Nr.: 2020-110</b> 1-Leiter-Federleiste; 1,5 mm <sup>2</sup> ; 10-polig; 1,50 mm <sup>2</sup> ; grau	<a href="http://www.wago.com/2020-110">www.wago.com/2020-110</a>
	<b>Art-Nr.: 2020-110/000-036</b> 1-Leiter-Federleiste; 1,5 mm <sup>2</sup> ; 10-polig; 1,50 mm <sup>2</sup> ; grau/gr-ge	<a href="http://www.wago.com/2020-110/000-036">www.wago.com/2020-110/000-036</a>
	<b>Art-Nr.: 2020-110/000-037</b> 1-Leiter-Federleiste; 1,5 mm <sup>2</sup> ; 10-polig; 1,50 mm <sup>2</sup> ; gr-ge/grau	<a href="http://www.wago.com/2020-110/000-037">www.wago.com/2020-110/000-037</a>
	<b>Art-Nr.: 2020-110/000-038</b> 1-Leiter-Federleiste; 1,5 mm <sup>2</sup> ; 10-polig; 1,50 mm <sup>2</sup> ; grau/blau/gr-ge	<a href="http://www.wago.com/2020-110/000-038">www.wago.com/2020-110/000-038</a>
	<b>Art-Nr.: 2020-110/000-039</b> 1-Leiter-Federleiste; 1,5 mm <sup>2</sup> ; 10-polig; 1,50 mm <sup>2</sup> ; gr-ge./blau/grau	<a href="http://www.wago.com/2020-110/000-039">www.wago.com/2020-110/000-039</a>
	<b>Art-Nr.: 2020-110/125-000</b> 1-Leiter-Federleiste; Verriegelungsklinke; 1,5 mm <sup>2</sup> ; 10-polig; 1,50 mm <sup>2</sup> ; grau	<a href="http://www.wago.com/2020-110/125-000">www.wago.com/2020-110/125-000</a>
	<b>Art-Nr.: 2020-110/135-000</b> 1-Leiter-Federleiste; Zugentlastungsplatte; 1,5 mm <sup>2</sup> ; 10-polig; 1,50 mm <sup>2</sup> ; grau	<a href="http://www.wago.com/2020-110/135-000">www.wago.com/2020-110/135-000</a>
	<b>Art-Nr.: 2020-110/145-000</b> 1-Leiter-Federleiste; Zugentlastungsplatte; 1,5 mm <sup>2</sup> ; 10-polig; 1,50 mm <sup>2</sup> ; grau	<a href="http://www.wago.com/2020-110/145-000">www.wago.com/2020-110/145-000</a>
	<b>Art-Nr.: 2020-111</b> 1-Leiter-Federleiste; 1,5 mm <sup>2</sup> ; 11-polig; 1,50 mm <sup>2</sup> ; grau	<a href="http://www.wago.com/2020-111">www.wago.com/2020-111</a>
	<b>Art-Nr.: 2020-111/000-036</b> 1-Leiter-Federleiste; 1,5 mm <sup>2</sup> ; 11-polig; 1,50 mm <sup>2</sup> ; grau/gr-ge	<a href="http://www.wago.com/2020-111/000-036">www.wago.com/2020-111/000-036</a>
	<b>Art-Nr.: 2020-111/000-037</b> 1-Leiter-Federleiste; 1,5 mm <sup>2</sup> ; 11-polig; 1,50 mm <sup>2</sup> ; gr-ge/grau	<a href="http://www.wago.com/2020-111/000-037">www.wago.com/2020-111/000-037</a>

Änderungen vorbehalten. Bitte beachten Sie auch die weitere Produktdokumentation!

	<b>Art-Nr.: 2020-111/000-038</b> 1-Leiter-Federleiste; 1,5 mm <sup>2</sup> ; 11-polig; 1,50 mm <sup>2</sup> ; grau/blau/gr-ge	<a href="http://www.wago.com/2020-111/000-038">www.wago.com/2020-111/000-038</a>
	<b>Art-Nr.: 2020-111/000-039</b> 1-Leiter-Federleiste; 1,5 mm <sup>2</sup> ; 11-polig; 1,50 mm <sup>2</sup> ; gr-ge./blau/grau	<a href="http://www.wago.com/2020-111/000-039">www.wago.com/2020-111/000-039</a>
	<b>Art-Nr.: 2020-111/125-000</b> 1-Leiter-Federleiste; Verriegelungsklinke; 1,5 mm <sup>2</sup> ; 11-polig; 1,50 mm <sup>2</sup> ; grau	<a href="http://www.wago.com/2020-111/125-000">www.wago.com/2020-111/125-000</a>
	<b>Art-Nr.: 2020-111/135-000</b> 1-Leiter-Federleiste; Zugentlastungsplatte; 1,5 mm <sup>2</sup> ; 11-polig; 1,50 mm <sup>2</sup> ; grau	<a href="http://www.wago.com/2020-111/135-000">www.wago.com/2020-111/135-000</a>
	<b>Art-Nr.: 2020-111/145-000</b> 1-Leiter-Federleiste; Zugentlastungsplatte; 1,5 mm <sup>2</sup> ; 11-polig; 1,50 mm <sup>2</sup> ; grau	<a href="http://www.wago.com/2020-111/145-000">www.wago.com/2020-111/145-000</a>
	<b>Art-Nr.: 2020-112</b> 1-Leiter-Federleiste; 1,5 mm <sup>2</sup> ; 12-polig; 1,50 mm <sup>2</sup> ; grau	<a href="http://www.wago.com/2020-112">www.wago.com/2020-112</a>
	<b>Art-Nr.: 2020-112/000-036</b> 1-Leiter-Federleiste; 1,5 mm <sup>2</sup> ; 12-polig; 1,50 mm <sup>2</sup> ; grau/gr-ge	<a href="http://www.wago.com/2020-112/000-036">www.wago.com/2020-112/000-036</a>
	<b>Art-Nr.: 2020-112/000-037</b> 1-Leiter-Federleiste; 1,5 mm <sup>2</sup> ; 12-polig; 1,50 mm <sup>2</sup> ; gr-ge/grau	<a href="http://www.wago.com/2020-112/000-037">www.wago.com/2020-112/000-037</a>
	<b>Art-Nr.: 2020-112/000-038</b> 1-Leiter-Federleiste; 1,5 mm <sup>2</sup> ; 12-polig; 1,50 mm <sup>2</sup> ; grau/blau/gr-ge	<a href="http://www.wago.com/2020-112/000-038">www.wago.com/2020-112/000-038</a>
	<b>Art-Nr.: 2020-112/000-039</b> 1-Leiter-Federleiste; 1,5 mm <sup>2</sup> ; 12-polig; 1,50 mm <sup>2</sup> ; gr-ge./blau/grau	<a href="http://www.wago.com/2020-112/000-039">www.wago.com/2020-112/000-039</a>
	<b>Art-Nr.: 2020-112/125-000</b> 1-Leiter-Federleiste; Verriegelungsklinke; 1,5 mm <sup>2</sup> ; 12-polig; 1,50 mm <sup>2</sup> ; grau	<a href="http://www.wago.com/2020-112/125-000">www.wago.com/2020-112/125-000</a>
	<b>Art-Nr.: 2020-112/135-000</b> 1-Leiter-Federleiste; Zugentlastungsplatte; 1,5 mm <sup>2</sup> ; 12-polig; 1,50 mm <sup>2</sup> ; grau	<a href="http://www.wago.com/2020-112/135-000">www.wago.com/2020-112/135-000</a>
	<b>Art-Nr.: 2020-112/145-000</b> 1-Leiter-Federleiste; Zugentlastungsplatte; 1,5 mm <sup>2</sup> ; 12-polig; 1,50 mm <sup>2</sup> ; grau	<a href="http://www.wago.com/2020-112/145-000">www.wago.com/2020-112/145-000</a>
	<b>Art-Nr.: 2020-113</b> 1-Leiter-Federleiste; 1,5 mm <sup>2</sup> ; 13-polig; 1,50 mm <sup>2</sup> ; grau	<a href="http://www.wago.com/2020-113">www.wago.com/2020-113</a>











Änderungen vorbehalten. Bitte beachten Sie auch die weitere Produktdokumentation!

	<b>Art-Nr.: 2020-113/000-036</b> 1-Leiter-Federleiste; 1,5 mm <sup>2</sup> ; 13-polig; 1,50 mm <sup>2</sup> ; grau/gr-ge	<a href="http://www.wago.com/2020-113/000-036">www.wago.com/2020-113/000-036</a>
	<b>Art-Nr.: 2020-113/000-037</b> 1-Leiter-Federleiste; 1,5 mm <sup>2</sup> ; 13-polig; 1,50 mm <sup>2</sup> ; gr-ge/grau	<a href="http://www.wago.com/2020-113/000-037">www.wago.com/2020-113/000-037</a>
	<b>Art-Nr.: 2020-113/000-038</b> 1-Leiter-Federleiste; 1,5 mm <sup>2</sup> ; 13-polig; 1,50 mm <sup>2</sup> ; grau/blau/gr-ge	<a href="http://www.wago.com/2020-113/000-038">www.wago.com/2020-113/000-038</a>
	<b>Art-Nr.: 2020-113/000-039</b> 1-Leiter-Federleiste; 1,5 mm <sup>2</sup> ; 13-polig; 1,50 mm <sup>2</sup> ; gr-ge./blau/grau	<a href="http://www.wago.com/2020-113/000-039">www.wago.com/2020-113/000-039</a>
	<b>Art-Nr.: 2020-113/125-000</b> 1-Leiter-Federleiste; Verriegelungsklinke; 1,5 mm <sup>2</sup> ; 13-polig; 1,50 mm <sup>2</sup> ; grau	<a href="http://www.wago.com/2020-113/125-000">www.wago.com/2020-113/125-000</a>
	<b>Art-Nr.: 2020-113/135-000</b> 1-Leiter-Federleiste; Zugentlastungsplatte; 1,5 mm <sup>2</sup> ; 13-polig; 1,50 mm <sup>2</sup> ; grau	<a href="http://www.wago.com/2020-113/135-000">www.wago.com/2020-113/135-000</a>
	<b>Art-Nr.: 2020-113/145-000</b> 1-Leiter-Federleiste; Zugentlastungsplatte; 1,5 mm <sup>2</sup> ; 13-polig; 1,50 mm <sup>2</sup> ; grau	<a href="http://www.wago.com/2020-113/145-000">www.wago.com/2020-113/145-000</a>
	<b>Art-Nr.: 2020-114</b> 1-Leiter-Federleiste; 1,5 mm <sup>2</sup> ; 14-polig; 1,50 mm <sup>2</sup> ; grau	<a href="http://www.wago.com/2020-114">www.wago.com/2020-114</a>
	<b>Art-Nr.: 2020-114/000-036</b> 1-Leiter-Federleiste; 1,5 mm <sup>2</sup> ; 14-polig; 1,50 mm <sup>2</sup> ; grau/gr-ge	<a href="http://www.wago.com/2020-114/000-036">www.wago.com/2020-114/000-036</a>
	<b>Art-Nr.: 2020-114/000-037</b> 1-Leiter-Federleiste; 1,5 mm <sup>2</sup> ; 14-polig; 1,50 mm <sup>2</sup> ; gr-ge/grau	<a href="http://www.wago.com/2020-114/000-037">www.wago.com/2020-114/000-037</a>
	<b>Art-Nr.: 2020-114/000-038</b> 1-Leiter-Federleiste; 1,5 mm <sup>2</sup> ; 14-polig; 1,50 mm <sup>2</sup> ; grau/blau/gr-ge	<a href="http://www.wago.com/2020-114/000-038">www.wago.com/2020-114/000-038</a>
	<b>Art-Nr.: 2020-114/000-039</b> 1-Leiter-Federleiste; 1,5 mm <sup>2</sup> ; 14-polig; 1,50 mm <sup>2</sup> ; gr-ge./blau/grau	<a href="http://www.wago.com/2020-114/000-039">www.wago.com/2020-114/000-039</a>
	<b>Art-Nr.: 2020-114/125-000</b> 1-Leiter-Federleiste; Verriegelungsklinke; 1,5 mm <sup>2</sup> ; 14-polig; 1,50 mm <sup>2</sup> ; grau	<a href="http://www.wago.com/2020-114/125-000">www.wago.com/2020-114/125-000</a>

Änderungen vorbehalten. Bitte beachten Sie auch die weitere Produktdokumentation!















WAGO Kontakttechnik GmbH & Co. KG  
Hansastr. 27  
32423 Minden  
Telefon: +49571 887-0 | Fax: +49571 887-169  
E-Mail: [info.de@wago.com](mailto:info.de@wago.com) | Web: [www.wago.com](http://www.wago.com)

Haben Sie Fragen zu unseren Produkten?  
Wir stehen Ihnen telefonisch unter +49 (571) 887-44222 gern zur Verfügung.















	<b>Art-Nr.: 2020-114/135-000</b> 1-Leiter-Federleiste; Zugentlastungsplatte; 1,5 mm <sup>2</sup> ; 14-polig; 1,50 mm <sup>2</sup> ; grau	<a href="http://www.wago.com/2020-114/135-000">www.wago.com/2020-114/135-000</a>
	<b>Art-Nr.: 2020-114/145-000</b> 1-Leiter-Federleiste; Zugentlastungsplatte; 1,5 mm <sup>2</sup> ; 14-polig; 1,50 mm <sup>2</sup> ; grau	<a href="http://www.wago.com/2020-114/145-000">www.wago.com/2020-114/145-000</a>
	<b>Art-Nr.: 2020-115</b> 1-Leiter-Federleiste; 1,5 mm <sup>2</sup> ; 15-polig; 1,50 mm <sup>2</sup> ; grau	<a href="http://www.wago.com/2020-115">www.wago.com/2020-115</a>
	<b>Art-Nr.: 2020-115/000-036</b> 1-Leiter-Federleiste; 1,5 mm <sup>2</sup> ; 15-polig; 1,50 mm <sup>2</sup> ; grau/gr-ge	<a href="http://www.wago.com/2020-115/000-036">www.wago.com/2020-115/000-036</a>
	<b>Art-Nr.: 2020-115/000-037</b> 1-Leiter-Federleiste; 1,5 mm <sup>2</sup> ; 15-polig; 1,50 mm <sup>2</sup> ; gr-ge/grau	<a href="http://www.wago.com/2020-115/000-037">www.wago.com/2020-115/000-037</a>
	<b>Art-Nr.: 2020-115/000-038</b> 1-Leiter-Federleiste; 1,5 mm <sup>2</sup> ; 15-polig; 1,50 mm <sup>2</sup> ; grau/blau/gr-ge	<a href="http://www.wago.com/2020-115/000-038">www.wago.com/2020-115/000-038</a>
	<b>Art-Nr.: 2020-115/000-039</b> 1-Leiter-Federleiste; 1,5 mm <sup>2</sup> ; 15-polig; 1,50 mm <sup>2</sup> ; gr-ge./blau/grau	<a href="http://www.wago.com/2020-115/000-039">www.wago.com/2020-115/000-039</a>
	<b>Art-Nr.: 2020-115/125-000</b> 1-Leiter-Federleiste; Verriegelungsklinke; 1,5 mm <sup>2</sup> ; 15-polig; 1,50 mm <sup>2</sup> ; grau	<a href="http://www.wago.com/2020-115/125-000">www.wago.com/2020-115/125-000</a>
	<b>Art-Nr.: 2020-115/135-000</b> 1-Leiter-Federleiste; Zugentlastungsplatte; 1,5 mm <sup>2</sup> ; 15-polig; 1,50 mm <sup>2</sup> ; grau	<a href="http://www.wago.com/2020-115/135-000">www.wago.com/2020-115/135-000</a>
	<b>Art-Nr.: 2020-115/145-000</b> 1-Leiter-Federleiste; Zugentlastungsplatte; 1,5 mm <sup>2</sup> ; 15-polig; 1,50 mm <sup>2</sup> ; grau	<a href="http://www.wago.com/2020-115/145-000">www.wago.com/2020-115/145-000</a>
	<b>Art-Nr.: 2020-161</b> 1-Leiter-Federleisten-Anfangsmodul; mit integrierter Abschlussplatte; 1,5 mm <sup>2</sup> ; 1-polig; 1,50 mm <sup>2</sup> ; grau	<a href="http://www.wago.com/2020-161">www.wago.com/2020-161</a>
	<b>Art-Nr.: 2020-164</b> 1-Leiter-Federleisten-Anfangsmodul; mit integrierter Abschlussplatte; 1,5 mm <sup>2</sup> ; 1-polig; 1,50 mm <sup>2</sup> ; blau	<a href="http://www.wago.com/2020-164">www.wago.com/2020-164</a>
	<b>Art-Nr.: 2020-167</b> 1-Leiter-Federleisten-Anfangsmodul; 1,5 mm <sup>2</sup> ; 1-polig; 1,50 mm <sup>2</sup> ; grün-gelb	<a href="http://www.wago.com/2020-167">www.wago.com/2020-167</a>
	<b>Art-Nr.: 2020-181</b> 1-Leiter-Federleisten-Endmodul; 1,5 mm <sup>2</sup> ; 1-polig; 1,50 mm <sup>2</sup> ; grau	<a href="http://www.wago.com/2020-181">www.wago.com/2020-181</a>
	<b>Art-Nr.: 2020-184</b> 1-Leiter-Federleisten-Endmodul; 1,5 mm <sup>2</sup> ; 1-polig; 1,50 mm <sup>2</sup> ; blau	<a href="http://www.wago.com/2020-184">www.wago.com/2020-184</a>

Änderungen vorbehalten. Bitte beachten Sie auch die weitere Produktdokumentation!



	<b>Art-Nr.: 2020-187</b> 1-Leiter-Federleisten-Endmodul; 1,5 mm <sup>2</sup> ; 1-polig; 1,50 mm <sup>2</sup> ; grün-gelb	<a href="http://www.wago.com/2020-187">www.wago.com/2020-187</a>
	<b>Art-Nr.: 2020-202</b> 2-Leiter-Federleiste; 1,5 mm <sup>2</sup> ; 2-polig; 1,50 mm <sup>2</sup> ; grau	<a href="http://www.wago.com/2020-202">www.wago.com/2020-202</a>
	<b>Art-Nr.: 2020-203</b> 2-Leiter-Federleiste; 1,5 mm <sup>2</sup> ; 3-polig; 1,50 mm <sup>2</sup> ; grau	<a href="http://www.wago.com/2020-203">www.wago.com/2020-203</a>
	<b>Art-Nr.: 2020-203/000-036</b> 2-Leiter-Federleiste; 1,5 mm <sup>2</sup> ; 3-polig; 1,50 mm <sup>2</sup> ; grau/gr-ge	<a href="http://www.wago.com/2020-203/000-036">www.wago.com/2020-203/000-036</a>
	<b>Art-Nr.: 2020-203/000-037</b> 2-Leiter-Federleiste; 1,5 mm <sup>2</sup> ; 3-polig; 1,50 mm <sup>2</sup> ; gr-ge/grau	<a href="http://www.wago.com/2020-203/000-037">www.wago.com/2020-203/000-037</a>
	<b>Art-Nr.: 2020-203/000-038</b> 2-Leiter-Federleiste; 1,5 mm <sup>2</sup> ; 3-polig; 1,50 mm <sup>2</sup> ; grau/blau/gr-ge	<a href="http://www.wago.com/2020-203/000-038">www.wago.com/2020-203/000-038</a>
	<b>Art-Nr.: 2020-203/000-039</b> 2-Leiter-Federleiste; 1,5 mm <sup>2</sup> ; 3-polig; 1,50 mm <sup>2</sup> ; gr-ge./blau/grau	<a href="http://www.wago.com/2020-203/000-039">www.wago.com/2020-203/000-039</a>
	<b>Art-Nr.: 2020-204</b> 2-Leiter-Federleiste; 1,5 mm <sup>2</sup> ; 4-polig; 1,50 mm <sup>2</sup> ; grau	<a href="http://www.wago.com/2020-204">www.wago.com/2020-204</a>
	<b>Art-Nr.: 2020-204/000-036</b> 2-Leiter-Federleiste; 1,5 mm <sup>2</sup> ; 4-polig; 1,50 mm <sup>2</sup> ; grau/gr-ge	<a href="http://www.wago.com/2020-204/000-036">www.wago.com/2020-204/000-036</a>
	<b>Art-Nr.: 2020-204/000-037</b> 2-Leiter-Federleiste; 1,5 mm <sup>2</sup> ; 4-polig; 1,50 mm <sup>2</sup> ; gr-ge/grau	<a href="http://www.wago.com/2020-204/000-037">www.wago.com/2020-204/000-037</a>
	<b>Art-Nr.: 2020-204/000-038</b> 2-Leiter-Federleiste; 1,5 mm <sup>2</sup> ; 4-polig; 1,50 mm <sup>2</sup> ; grau/blau/gr-ge	<a href="http://www.wago.com/2020-204/000-038">www.wago.com/2020-204/000-038</a>
	<b>Art-Nr.: 2020-204/000-039</b> 2-Leiter-Federleiste; 1,5 mm <sup>2</sup> ; 4-polig; 1,50 mm <sup>2</sup> ; gr-ge./blau/grau	<a href="http://www.wago.com/2020-204/000-039">www.wago.com/2020-204/000-039</a>
	<b>Art-Nr.: 2020-205</b> 2-Leiter-Federleiste; 1,5 mm <sup>2</sup> ; 5-polig; 1,50 mm <sup>2</sup> ; grau	<a href="http://www.wago.com/2020-205">www.wago.com/2020-205</a>
	<b>Art-Nr.: 2020-205/000-036</b> 2-Leiter-Federleiste; 1,5 mm <sup>2</sup> ; 5-polig; 1,50 mm <sup>2</sup> ; grau/gr-ge	<a href="http://www.wago.com/2020-205/000-036">www.wago.com/2020-205/000-036</a>
	<b>Art-Nr.: 2020-205/000-037</b> 2-Leiter-Federleiste; 1,5 mm <sup>2</sup> ; 5-polig; 1,50 mm <sup>2</sup> ; gr-ge/grau	<a href="http://www.wago.com/2020-205/000-037">www.wago.com/2020-205/000-037</a>

Änderungen vorbehalten. Bitte beachten Sie auch die weitere Produktdokumentation!

	<b>Art-Nr.: 2020-205/000-038</b> 2-Leiter-Federleiste; 1,5 mm <sup>2</sup> ; 5-polig; 1,50 mm <sup>2</sup> ; grau/blau/gr-ge	<a href="http://www.wago.com/2020-205/000-038">www.wago.com/2020-205/000-038</a>
	<b>Art-Nr.: 2020-205/000-039</b> 2-Leiter-Federleiste; 1,5 mm <sup>2</sup> ; 5-polig; 1,50 mm <sup>2</sup> ; gr-ge./blau/grau	<a href="http://www.wago.com/2020-205/000-039">www.wago.com/2020-205/000-039</a>
	<b>Art-Nr.: 2020-206</b> 2-Leiter-Federleiste; 1,5 mm <sup>2</sup> ; 6-polig; 1,50 mm <sup>2</sup> ; grau	<a href="http://www.wago.com/2020-206">www.wago.com/2020-206</a>
	<b>Art-Nr.: 2020-206/000-036</b> 2-Leiter-Federleiste; 1,5 mm <sup>2</sup> ; 6-polig; 1,50 mm <sup>2</sup> ; grau/gr-ge	<a href="http://www.wago.com/2020-206/000-036">www.wago.com/2020-206/000-036</a>
	<b>Art-Nr.: 2020-206/000-037</b> 2-Leiter-Federleiste; 1,5 mm <sup>2</sup> ; 6-polig; 1,50 mm <sup>2</sup> ; gr-ge/grau	<a href="http://www.wago.com/2020-206/000-037">www.wago.com/2020-206/000-037</a>
	<b>Art-Nr.: 2020-206/000-038</b> 2-Leiter-Federleiste; 1,5 mm <sup>2</sup> ; 6-polig; 1,50 mm <sup>2</sup> ; grau/blau/gr-ge	<a href="http://www.wago.com/2020-206/000-038">www.wago.com/2020-206/000-038</a>
	<b>Art-Nr.: 2020-206/000-039</b> 2-Leiter-Federleiste; 1,5 mm <sup>2</sup> ; 6-polig; 1,50 mm <sup>2</sup> ; gr-ge./blau/grau	<a href="http://www.wago.com/2020-206/000-039">www.wago.com/2020-206/000-039</a>
	<b>Art-Nr.: 2020-207</b> 2-Leiter-Federleiste; 1,5 mm <sup>2</sup> ; 7-polig; 1,50 mm <sup>2</sup> ; grau	<a href="http://www.wago.com/2020-207">www.wago.com/2020-207</a>
	<b>Art-Nr.: 2020-207/000-036</b> 2-Leiter-Federleiste; 1,5 mm <sup>2</sup> ; 7-polig; 1,50 mm <sup>2</sup> ; grau/gr-ge	<a href="http://www.wago.com/2020-207/000-036">www.wago.com/2020-207/000-036</a>
	<b>Art-Nr.: 2020-207/000-037</b> 2-Leiter-Federleiste; 1,5 mm <sup>2</sup> ; 7-polig; 1,50 mm <sup>2</sup> ; gr-ge/grau	<a href="http://www.wago.com/2020-207/000-037">www.wago.com/2020-207/000-037</a>
	<b>Art-Nr.: 2020-207/000-038</b> 2-Leiter-Federleiste; 1,5 mm <sup>2</sup> ; 7-polig; 1,50 mm <sup>2</sup> ; grau/blau/gr-ge	<a href="http://www.wago.com/2020-207/000-038">www.wago.com/2020-207/000-038</a>
	<b>Art-Nr.: 2020-207/000-039</b> 2-Leiter-Federleiste; 1,5 mm <sup>2</sup> ; 7-polig; 1,50 mm <sup>2</sup> ; gr-ge./blau/grau	<a href="http://www.wago.com/2020-207/000-039">www.wago.com/2020-207/000-039</a>
	<b>Art-Nr.: 2020-208</b> 2-Leiter-Federleiste; 1,5 mm <sup>2</sup> ; 8-polig; 1,50 mm <sup>2</sup> ; grau	<a href="http://www.wago.com/2020-208">www.wago.com/2020-208</a>
	<b>Art-Nr.: 2020-208/000-036</b> 2-Leiter-Federleiste; 1,5 mm <sup>2</sup> ; 8-polig; 1,50 mm <sup>2</sup> ; grau/gr-ge	<a href="http://www.wago.com/2020-208/000-036">www.wago.com/2020-208/000-036</a>

Änderungen vorbehalten. Bitte beachten Sie auch die weitere Produktdokumentation!

WAGO Kontakttechnik GmbH & Co. KG  
 Hansastr. 27  
 32423 Minden  
 Telefon: +49571 887-0 | Fax: +49571 887-169  
 E-Mail: [info.de@wago.com](mailto:info.de@wago.com) | Web: [www.wago.com](http://www.wago.com)

Haben Sie Fragen zu unseren Produkten?  
 Wir stehen Ihnen telefonisch unter +49 (571) 887-44222 gern zur Verfügung.



**Art-Nr.: 2020-208/000-037**  
2-Leiter-Federleiste; 1,5 mm<sup>2</sup>; 8-polig; 1,50 mm<sup>2</sup>; gr-ge/grau

[www.wago.com/2020-208/000-037](http://www.wago.com/2020-208/000-037)



**Art-Nr.: 2020-208/000-038**  
2-Leiter-Federleiste; 1,5 mm<sup>2</sup>; 8-polig; 1,50 mm<sup>2</sup>; grau/blau/gr-ge

[www.wago.com/2020-208/000-038](http://www.wago.com/2020-208/000-038)



**Art-Nr.: 2020-208/000-039**  
2-Leiter-Federleiste; 1,5 mm<sup>2</sup>; 8-polig; 1,50 mm<sup>2</sup>; gr-ge./blau/grau

[www.wago.com/2020-208/000-039](http://www.wago.com/2020-208/000-039)



**Art-Nr.: 2020-209**  
2-Leiter-Federleiste; 1,5 mm<sup>2</sup>; 9-polig; 1,50 mm<sup>2</sup>; grau

[www.wago.com/2020-209](http://www.wago.com/2020-209)



**Art-Nr.: 2020-209/000-036**  
2-Leiter-Federleiste; 1,5 mm<sup>2</sup>; 9-polig; 1,50 mm<sup>2</sup>; grau/gr-ge

[www.wago.com/2020-209/000-036](http://www.wago.com/2020-209/000-036)



**Art-Nr.: 2020-209/000-037**  
2-Leiter-Federleiste; 1,5 mm<sup>2</sup>; 9-polig; 1,50 mm<sup>2</sup>; gr-ge/grau

[www.wago.com/2020-209/000-037](http://www.wago.com/2020-209/000-037)



**Art-Nr.: 2020-209/000-038**  
2-Leiter-Federleiste; 1,5 mm<sup>2</sup>; 9-polig; 1,50 mm<sup>2</sup>; grau/blau/gr-ge

[www.wago.com/2020-209/000-038](http://www.wago.com/2020-209/000-038)



**Art-Nr.: 2020-209/000-039**  
2-Leiter-Federleiste; 1,5 mm<sup>2</sup>; 9-polig; 1,50 mm<sup>2</sup>; gr-ge./blau/grau

[www.wago.com/2020-209/000-039](http://www.wago.com/2020-209/000-039)



**Art-Nr.: 2020-210**  
2-Leiter-Federleiste; 1,5 mm<sup>2</sup>; 10-polig; 1,50 mm<sup>2</sup>; grau

[www.wago.com/2020-210](http://www.wago.com/2020-210)



**Art-Nr.: 2020-210/000-036**  
2-Leiter-Federleiste; 1,5 mm<sup>2</sup>; 10-polig; 1,50 mm<sup>2</sup>; grau/gr-ge

[www.wago.com/2020-210/000-036](http://www.wago.com/2020-210/000-036)



**Art-Nr.: 2020-210/000-037**  
2-Leiter-Federleiste; 1,5 mm<sup>2</sup>; 10-polig; 1,50 mm<sup>2</sup>; gr-ge/grau

[www.wago.com/2020-210/000-037](http://www.wago.com/2020-210/000-037)



**Art-Nr.: 2020-210/000-038**  
2-Leiter-Federleiste; 1,5 mm<sup>2</sup>; 10-polig; 1,50 mm<sup>2</sup>; grau/blau/gr-ge

[www.wago.com/2020-210/000-038](http://www.wago.com/2020-210/000-038)



**Art-Nr.: 2020-210/000-039**  
2-Leiter-Federleiste; 1,5 mm<sup>2</sup>; 10-polig; 1,50 mm<sup>2</sup>; gr-ge./blau/grau

[www.wago.com/2020-210/000-039](http://www.wago.com/2020-210/000-039)



**Art-Nr.: 2020-211**  
2-Leiter-Federleiste; 1,5 mm<sup>2</sup>; 11-polig; 1,50 mm<sup>2</sup>; grau

[www.wago.com/2020-211](http://www.wago.com/2020-211)

Änderungen vorbehalten. Bitte beachten Sie auch die weitere Produktdokumentation!

WAGO Kontakttechnik GmbH & Co. KG  
Hansastr. 27  
32423 Minden  
Telefon: +49571 887-0 | Fax: +49571 887-169  
E-Mail: [info.de@wago.com](mailto:info.de@wago.com) | Web: [www.wago.com](http://www.wago.com)

Haben Sie Fragen zu unseren Produkten?  
Wir stehen Ihnen telefonisch unter +49 (571) 887-44222 gern zur Verfügung.



**Art-Nr.: 2020-211/000-036**  
2-Leiter-Federleiste; 1,5 mm<sup>2</sup>; 11-polig; 1,50 mm<sup>2</sup>; grau/gr-ge

[www.wago.com/2020-211/000-036](http://www.wago.com/2020-211/000-036)



**Art-Nr.: 2020-211/000-037**  
2-Leiter-Federleiste; 1,5 mm<sup>2</sup>; 11-polig; 1,50 mm<sup>2</sup>; gr-ge/grau

[www.wago.com/2020-211/000-037](http://www.wago.com/2020-211/000-037)



**Art-Nr.: 2020-211/000-038**  
2-Leiter-Federleiste; 1,5 mm<sup>2</sup>; 11-polig; 1,50 mm<sup>2</sup>; grau/blau/gr-ge

[www.wago.com/2020-211/000-038](http://www.wago.com/2020-211/000-038)



**Art-Nr.: 2020-211/000-039**  
2-Leiter-Federleiste; 1,5 mm<sup>2</sup>; 11-polig; 1,50 mm<sup>2</sup>; gr-ge./blau/grau

[www.wago.com/2020-211/000-039](http://www.wago.com/2020-211/000-039)



**Art-Nr.: 2020-212**  
2-Leiter-Federleiste; 1,5 mm<sup>2</sup>; 12-polig; 1,50 mm<sup>2</sup>; grau

[www.wago.com/2020-212](http://www.wago.com/2020-212)



**Art-Nr.: 2020-212/000-036**  
2-Leiter-Federleiste; 1,5 mm<sup>2</sup>; 12-polig; 1,50 mm<sup>2</sup>; grau/gr-ge

[www.wago.com/2020-212/000-036](http://www.wago.com/2020-212/000-036)



**Art-Nr.: 2020-212/000-037**  
2-Leiter-Federleiste; 1,5 mm<sup>2</sup>; 12-polig; 1,50 mm<sup>2</sup>; gr-ge/grau

[www.wago.com/2020-212/000-037](http://www.wago.com/2020-212/000-037)



**Art-Nr.: 2020-212/000-038**  
2-Leiter-Federleiste; 1,5 mm<sup>2</sup>; 12-polig; 1,50 mm<sup>2</sup>; grau/blau/gr-ge

[www.wago.com/2020-212/000-038](http://www.wago.com/2020-212/000-038)



**Art-Nr.: 2020-212/000-039**  
2-Leiter-Federleiste; 1,5 mm<sup>2</sup>; 12-polig; 1,50 mm<sup>2</sup>; gr-ge./blau/grau

[www.wago.com/2020-212/000-039](http://www.wago.com/2020-212/000-039)



**Art-Nr.: 2020-213**  
2-Leiter-Federleiste; 1,5 mm<sup>2</sup>; 13-polig; 1,50 mm<sup>2</sup>; grau

[www.wago.com/2020-213](http://www.wago.com/2020-213)



**Art-Nr.: 2020-213/000-036**  
2-Leiter-Federleiste; 1,5 mm<sup>2</sup>; 13-polig; 1,50 mm<sup>2</sup>; grau/gr-ge

[www.wago.com/2020-213/000-036](http://www.wago.com/2020-213/000-036)



**Art-Nr.: 2020-213/000-037**  
2-Leiter-Federleiste; 1,5 mm<sup>2</sup>; 13-polig; 1,50 mm<sup>2</sup>; gr-ge/grau

[www.wago.com/2020-213/000-037](http://www.wago.com/2020-213/000-037)



**Art-Nr.: 2020-213/000-038**  
2-Leiter-Federleiste; 1,5 mm<sup>2</sup>; 13-polig; 1,50 mm<sup>2</sup>; grau/blau/gr-ge

[www.wago.com/2020-213/000-038](http://www.wago.com/2020-213/000-038)

















**Art-Nr.: 2020-213/000-039**  
2-Leiter-Federleiste; 1,5 mm<sup>2</sup>; 13-polig; 1,50 mm<sup>2</sup>; gr-ge./blau/grau

[www.wago.com/2020-213/000-039](http://www.wago.com/2020-213/000-039)

Änderungen vorbehalten. Bitte beachten Sie auch die weitere Produktdokumentation!

WAGO Kontakttechnik GmbH & Co. KG  
Hansastr. 27  
32423 Minden  
Telefon: +49571 887-0 | Fax: +49571 887-169  
E-Mail: [info.de@wago.com](mailto:info.de@wago.com) | Web: [www.wago.com](http://www.wago.com)

Haben Sie Fragen zu unseren Produkten?  
Wir stehen Ihnen telefonisch unter +49 (571) 887-44222 gern zur Verfügung.

	<b>Art-Nr.: 2020-214</b> 2-Leiter-Federleiste; 1,5 mm <sup>2</sup> ; 14-polig; 1,50 mm <sup>2</sup> ; grau	<a href="http://www.wago.com/2020-214">www.wago.com/2020-214</a>
	<b>Art-Nr.: 2020-214/000-036</b> 2-Leiter-Federleiste; 1,5 mm <sup>2</sup> ; 14-polig; 1,50 mm <sup>2</sup> ; grau/gr-ge	<a href="http://www.wago.com/2020-214/000-036">www.wago.com/2020-214/000-036</a>
	<b>Art-Nr.: 2020-214/000-037</b> 2-Leiter-Federleiste; 1,5 mm <sup>2</sup> ; 14-polig; 1,50 mm <sup>2</sup> ; gr-ge/grau	<a href="http://www.wago.com/2020-214/000-037">www.wago.com/2020-214/000-037</a>
	<b>Art-Nr.: 2020-214/000-038</b> 2-Leiter-Federleiste; 1,5 mm <sup>2</sup> ; 14-polig; 1,50 mm <sup>2</sup> ; grau/blau/gr-ge	<a href="http://www.wago.com/2020-214/000-038">www.wago.com/2020-214/000-038</a>
	<b>Art-Nr.: 2020-214/000-039</b> 2-Leiter-Federleiste; 1,5 mm <sup>2</sup> ; 14-polig; 1,50 mm <sup>2</sup> ; gr-ge./blau/grau	<a href="http://www.wago.com/2020-214/000-039">www.wago.com/2020-214/000-039</a>
	<b>Art-Nr.: 2020-215</b> 2-Leiter-Federleiste; 1,5 mm <sup>2</sup> ; 15-polig; 1,50 mm <sup>2</sup> ; grau	<a href="http://www.wago.com/2020-215">www.wago.com/2020-215</a>
	<b>Art-Nr.: 2020-215/000-036</b> 2-Leiter-Federleiste; 1,5 mm <sup>2</sup> ; 15-polig; 1,50 mm <sup>2</sup> ; grau/gr-ge	<a href="http://www.wago.com/2020-215/000-036">www.wago.com/2020-215/000-036</a>
	<b>Art-Nr.: 2020-215/000-037</b> 2-Leiter-Federleiste; 1,5 mm <sup>2</sup> ; 15-polig; 1,50 mm <sup>2</sup> ; gr-ge/grau	<a href="http://www.wago.com/2020-215/000-037">www.wago.com/2020-215/000-037</a>
	<b>Art-Nr.: 2020-215/000-038</b> 2-Leiter-Federleiste; 1,5 mm <sup>2</sup> ; 15-polig; 1,50 mm <sup>2</sup> ; grau/blau/gr-ge	<a href="http://www.wago.com/2020-215/000-038">www.wago.com/2020-215/000-038</a>
	<b>Art-Nr.: 2020-215/000-039</b> 2-Leiter-Federleiste; 1,5 mm <sup>2</sup> ; 15-polig; 1,50 mm <sup>2</sup> ; gr-ge./blau/grau	<a href="http://www.wago.com/2020-215/000-039">www.wago.com/2020-215/000-039</a>
	<b>Art-Nr.: 2020-261</b> 2-Leiter-Federleisten-Anfangsmodul; mit integrierter Abschlussplatte; 1,5 mm <sup>2</sup> ; 1-polig; 1,50 mm <sup>2</sup> ; grau	<a href="http://www.wago.com/2020-261">www.wago.com/2020-261</a>
	<b>Art-Nr.: 2020-264</b> 2-Leiter-Federleisten-Anfangsmodul; mit integrierter Abschlussplatte; 1,5 mm <sup>2</sup> ; 1-polig; 1,50 mm <sup>2</sup> ; blau	<a href="http://www.wago.com/2020-264">www.wago.com/2020-264</a>
	<b>Art-Nr.: 2020-267</b> 2-Leiter-Federleisten-Anfangsmodul; 1,5 mm <sup>2</sup> ; 1-polig; 1,50 mm <sup>2</sup> ; grün-gelb	<a href="http://www.wago.com/2020-267">www.wago.com/2020-267</a>
	<b>Art-Nr.: 2020-281</b> 2-Leiter-Federleisten-Endmodul; 1,5 mm <sup>2</sup> ; 1-polig; 1,50 mm <sup>2</sup> ; grau	<a href="http://www.wago.com/2020-281">www.wago.com/2020-281</a>
	<b>Art-Nr.: 2020-284</b> 2-Leiter-Federleisten-Endmodul; 1,5 mm <sup>2</sup> ; 1-polig; 1,50 mm <sup>2</sup> ; blau	<a href="http://www.wago.com/2020-284">www.wago.com/2020-284</a>









Änderungen vorbehalten. Bitte beachten Sie auch die weitere Produktdokumentation!









**Art-Nr.: 2020-287**  
2-Leiter-Federleisten-Endmodul; 1,5 mm<sup>2</sup>; 1-polig; 1,50 mm<sup>2</sup>; grün-gelb

[www.wago.com/2020-287](http://www.wago.com/2020-287)

### Tragschiene

	<b>Art-Nr.: 210-112</b> Stahltragschiene; 35 x 7,5 mm; 1 mm dick; 2 m lang; gelocht; entsprechend EN 60715; Lochbreite 25 mm; Lochabstand 36 mm; silberfarben	<a href="http://www.wago.com/210-112">www.wago.com/210-112</a>
	<b>Art-Nr.: 210-113</b> Stahltragschiene; 35 x 7,5 mm; 1 mm dick; 2 m lang; ungelocht; entsprechend EN 60715; silberfarben	<a href="http://www.wago.com/210-113">www.wago.com/210-113</a>
	<b>Art-Nr.: 210-114</b> Stahltragschiene; 35 x 15 mm; 1,5 mm dick; 2 m lang; ungelocht; ähnlich EN 60715; silberfarben	<a href="http://www.wago.com/210-114">www.wago.com/210-114</a>
	<b>Art-Nr.: 210-115</b> Stahltragschiene; 35 x 7,5 mm; 1 mm dick; 2 m lang; gelocht; entsprechend EN 60715; Lochbreite 18 mm; Lochabstand 25 mm; silberfarben	<a href="http://www.wago.com/210-115">www.wago.com/210-115</a>
	<b>Art-Nr.: 210-118</b> Stahltragschiene; 35 x 15 mm; 2,3 mm dick; 2 m lang; ungelocht; entsprechend EN 60715; silberfarben	<a href="http://www.wago.com/210-118">www.wago.com/210-118</a>
	<b>Art-Nr.: 210-196</b> Aluminiumtragschiene; 35 x 8,2 mm; 1,6 mm dick; 2 m lang; ungelocht; ähnlich EN 60715; silberfarben	<a href="http://www.wago.com/210-196">www.wago.com/210-196</a>
	<b>Art-Nr.: 210-197</b> Stahltragschiene; 35 x 15 mm; 1,5 mm dick; 2 m lang; gelocht; ähnlich EN 60715; silberfarben	<a href="http://www.wago.com/210-197">www.wago.com/210-197</a>
	<b>Art-Nr.: 210-198</b> Kupfertragschiene; 35 x 15 mm; 2,3 mm dick; 2 m lang; ungelocht; entsprechend EN 60715; kupferfarben	<a href="http://www.wago.com/210-198">www.wago.com/210-198</a>







### Beschriftungsmaterial

	<b>Art-Nr.: 2000-121</b> Adapter; grau	<a href="http://www.wago.com/2000-121">www.wago.com/2000-121</a>
	<b>Art-Nr.: 2009-110</b> Beschriftungsstreifen; für Smart Printer; auf Rolle; nicht dehnbar; unbedruckt; aufrastbar; weiß	<a href="http://www.wago.com/2009-110">www.wago.com/2009-110</a>
	<b>Art-Nr.: 2009-113</b> WMB-Inline; für Smart Printer; 2300 Stück auf Rolle; unbedruckt; aufrastbar; weiß	<a href="http://www.wago.com/2009-113">www.wago.com/2009-113</a>
	<b>Art-Nr.: 2009-113/000-002</b> WMB-Inline; für Smart Printer; 2300 Stück auf Rolle; unbedruckt; aufrastbar; gelb	<a href="http://www.wago.com/2009-113/000-002">www.wago.com/2009-113/000-002</a>
	<b>Art-Nr.: 2009-113/000-005</b> WMB-Inline; für Smart Printer; 2300 Stück auf Rolle; unbedruckt; aufrastbar; rot	<a href="http://www.wago.com/2009-113/000-005">www.wago.com/2009-113/000-005</a>
	<b>Art-Nr.: 2009-113/000-006</b> WMB-Inline; für Smart Printer; 2300 Stück auf Rolle; unbedruckt; aufrastbar; blau	<a href="http://www.wago.com/2009-113/000-006">www.wago.com/2009-113/000-006</a>
	<b>Art-Nr.: 2009-113/000-007</b> WMB-Inline; für Smart Printer; 2300 Stück auf Rolle; unbedruckt; aufrastbar; grau	<a href="http://www.wago.com/2009-113/000-007">www.wago.com/2009-113/000-007</a>

Änderungen vorbehalten. Bitte beachten Sie auch die weitere Produktdokumentation!

WAGO Kontakttechnik GmbH & Co. KG  
Hansastr. 27  
32423 Minden  
Telefon: +49571 887-0 | Fax: +49571 887-169  
E-Mail: [info.de@wago.com](mailto:info.de@wago.com) | Web: [www.wago.com](http://www.wago.com)

Haben Sie Fragen zu unseren Produkten?  
Wir stehen Ihnen telefonisch unter +49 (571) 887-44222 gern zur Verfügung.

	<b>Art-Nr.: 2009-113/000-012</b> WMB-Inline; für Smart Printer; 2300 Stück auf Rolle; unbedruckt; aufrastbar; orange	<a href="http://www.wago.com/2009-113/000-012">www.wago.com/2009-113/000-012</a>
	<b>Art-Nr.: 2009-113/000-017</b> WMB-Inline; für Smart Printer; 2300 Stück auf Rolle; unbedruckt; aufrastbar; hellgrün	<a href="http://www.wago.com/2009-113/000-017">www.wago.com/2009-113/000-017</a>
	<b>Art-Nr.: 2009-113/000-023</b> WMB-Inline; für Smart Printer; 2300 Stück auf Rolle; unbedruckt; aufrastbar; grün	<a href="http://www.wago.com/2009-113/000-023">www.wago.com/2009-113/000-023</a>
	<b>Art-Nr.: 2009-113/000-024</b> WMB-Inline; für Smart Printer; 2300 Stück auf Rolle; unbedruckt; aufrastbar; violett	<a href="http://www.wago.com/2009-113/000-024">www.wago.com/2009-113/000-024</a>
	<b>Art-Nr.: 2009-191</b> Gruppenschildträger	<a href="http://www.wago.com/2009-191">www.wago.com/2009-191</a>
	<b>Art-Nr.: 793-3501</b> WMB-Beschriftungskarte; als Karte; unbedruckt; aufrastbar; weiß	<a href="http://www.wago.com/793-3501">www.wago.com/793-3501</a>

## Downloads

### Dokumentation

#### Ausschreibungstext

2020-5477/1102-953 X81 - Datei	19. 2. 2019	xml 4,3 kB	Download
-----------------------------------	-------------	---------------	----------

2020-5477/1102-953 docx - Datei	7. 8. 2018	docx 15,5 kB	Download
------------------------------------	------------	-----------------	----------

#### Weitere Informationen

Technische Erläuterungen	3. 4. 2019	pdf 2,2 MB	Download
--------------------------	------------	---------------	----------

## CAD/CAE-Daten

### CAD Daten

2D/3D Modelle 2020-5477/1102-953	URL	Download
----------------------------------	-----	----------

### CAE Daten

ZUKEN Portal 2020-5477/1102-953	URL	Download
---------------------------------	-----	----------

Änderungen vorbehalten. Bitte beachten Sie auch die weitere Produktdokumentation!

WAGO Kontakttechnik GmbH & Co. KG  
Hansastr. 27  
32423 Minden  
Telefon: +49571 887-0 | Fax: +49571 887-169  
E-Mail: [info.de@wago.com](mailto:info.de@wago.com) | Web: [www.wago.com](http://www.wago.com)

Haben Sie Fragen zu unseren Produkten?  
Wir stehen Ihnen telefonisch unter +49 (571) 887-44222 gern zur Verfügung.

## Environmental Product Compliance

### Compliance Search

Environmental Product Compliance 2020-5477/1102-953

[URL](#)

[Download](#)

4-Leiter-Initiatoreneinspeiseklemme; LED grün; mit PE-Anschluss; mit steckbarer Signalebene; 1 mm<sup>2</sup>; Push-in CAGE CLAMP®; 1,00 mm<sup>2</sup>; orange

## Handhabungshinweise

### Montieren

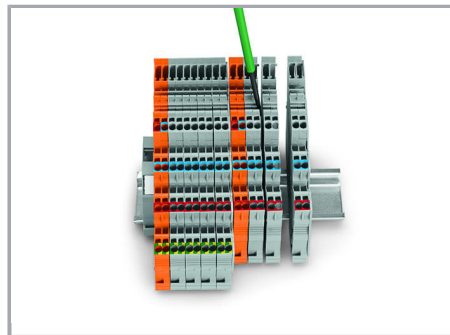
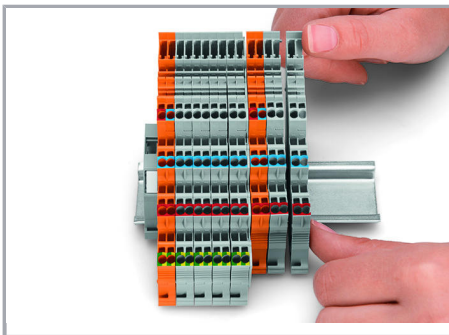

Einzelne Klemmen auf die Tragschiene montieren und anschließend zusammenrasten.

Untereinander verrastete Klemmen werden mit Hilfe eines Betätigungswerkzeugs getrennt und auseinandergeschoben.

### Prüfen

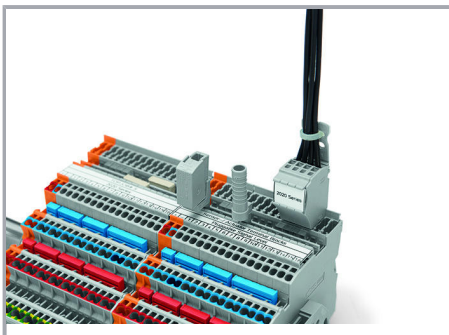

Prüfen mit Prüfabgriff (2009-182) oder Prüfadapter (2009-174) (bis max. 42 V)

Änderungen vorbehalten. Bitte beachten Sie auch die weitere Produktdokumentation!



### Kodieren

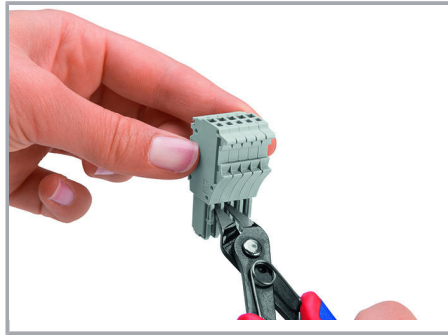
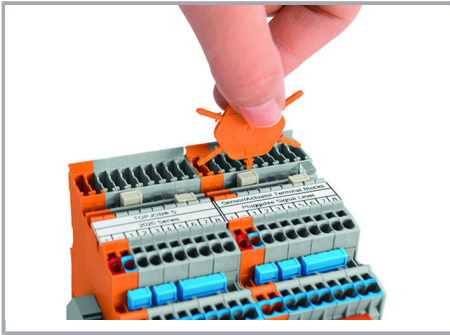

Kodierstift in gewünschte Kodieröffnung der Klemme einführen und abdrehen.

Kodiernase mittels Schneidwerkzeug entfernen.

### Verriegelung

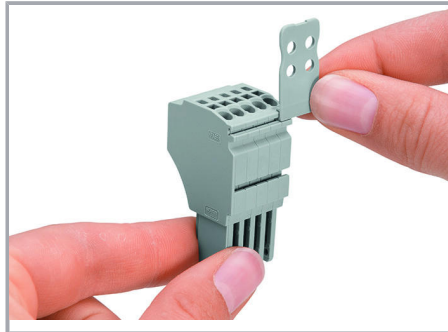
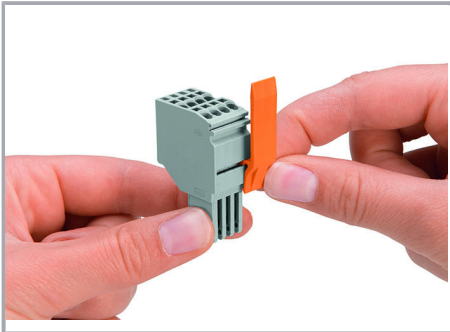

Verriegelungsklinke an die gewünschte Position schieben.

### Zugentlastung

Änderungen vorbehalten. Bitte beachten Sie auch die weitere Produktdokumentation!

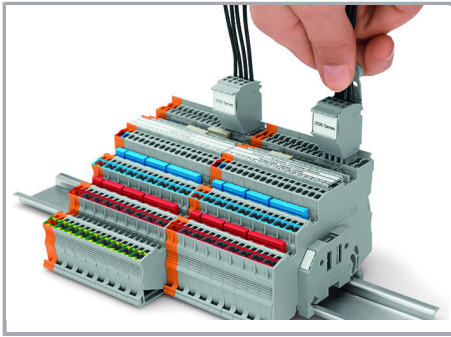

Federleiste am zugentlasteten Leiterbündel herausziehen.

### Beschriften

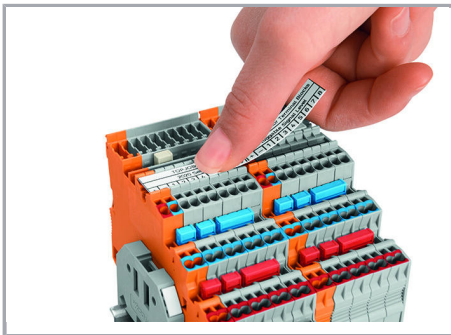

Klemmen sind mit Beschriftungsstreifen (2009-110) oder WMB-Beschriftungsschildern 3,5 mm (793-35xx) oben oder seitlich beschriftbar.

### Produktfamilie

#### TOPJOB® S

TOPJOB® S: Das breite und flexible Produktprogramm an Reihenklemmen bietet in diversen Industrieanwendungen und in der modernen Gebäudeinstallation mehr als nur eine sichere elektrische Verbindung.

[Alle Produkte der Familie anzeigen](#)

Änderungen vorbehalten. Bitte beachten Sie auch die weitere Produktdokumentation!