

## 2J6924B

### CELLULAR/LTE Screw Mount

#### Key Features

##### CELLULAR / LTE

- 698-960 MHz
- 1710-2170 MHz
- 2500-2700 MHz

Screw Mount

Low Profile

Anti-Rotation Mechanism

Ground Plane Independent

Customizable Cable and Connector

Dimensions 80 × 74 × 25.6 mm

Certificates: IP67, IP69



## 1. Antenna and electrical specifications

Cable 1

Parameters	CELLULAR / LTE Antenna		
<b>Standards</b>	2G,3G and 4G		
<b>Band (MHz)</b>	700/850/900	1700/1800/1900/2100	2600
<b>Frequency (MHz)</b>	698-960	1710-2170	2500-2700
<b>Return Loss (dB)</b>	~-13.6	~-12.7	~-14.4
<b>VSWR</b>	~1.9:1	~2.2:1	~1.3:1
<b>Efficiency (%)</b>	~52.3	~45.0	~46.3
<b>Peak Gain (dBi)</b>	~3.1	~3.5	~3.4
<b>Average Gain (dB)</b>	~-2.8	~-3.3	~-3.3
<b>Impedance (Ohm)</b>	50		
<b>Polarisation</b>	Linear		
<b>Radiation Pattern</b>	Omni-Directional		
<b>Max. Input Power (W)</b>	25		
<b>Connector Type</b>	SMA-Male Standard (Other Connectors Available)		
<b>Cable Length</b>	300 cm Standard (Any Cable Length Available)		
<b>Cable Type</b>	D302 Standard (Other Cables Available)		

### Antenna Measurement Conditions:

Mounted on 30 x 30 x 0.25 cm ABS Plate

200 cm of Cable D302

Measured in Certified CTIA 3D Anechoic Chamber

## 2. Mechanical and environmental specifications

Specifications	2J6924B
<b>Mounting Type</b>	Screw Mount
<b>Dimensions (mm)</b>	80 x 74 x 25.6
<b>Max. Tighten Torque (Nm)</b>	5 Nm
<b>Radome Type</b>	ABS UV Stable
<b>Radome Color</b>	Black, White
<b>Operating Temperature (C)</b>	-40 to +85
<b>Storage Temperature (C)</b>	-40 to +85
<b>Substance Compliance</b>	RoHS
<b>Certificates</b>	IP67, IP69

### 3. Antenna parameters

Cable 1: CELLULAR/LTE

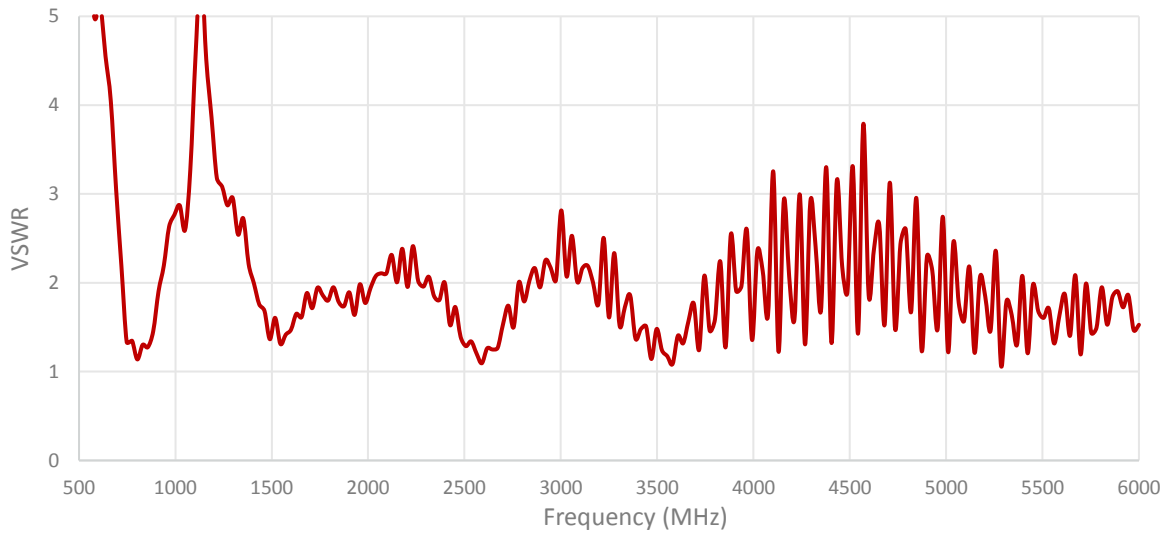
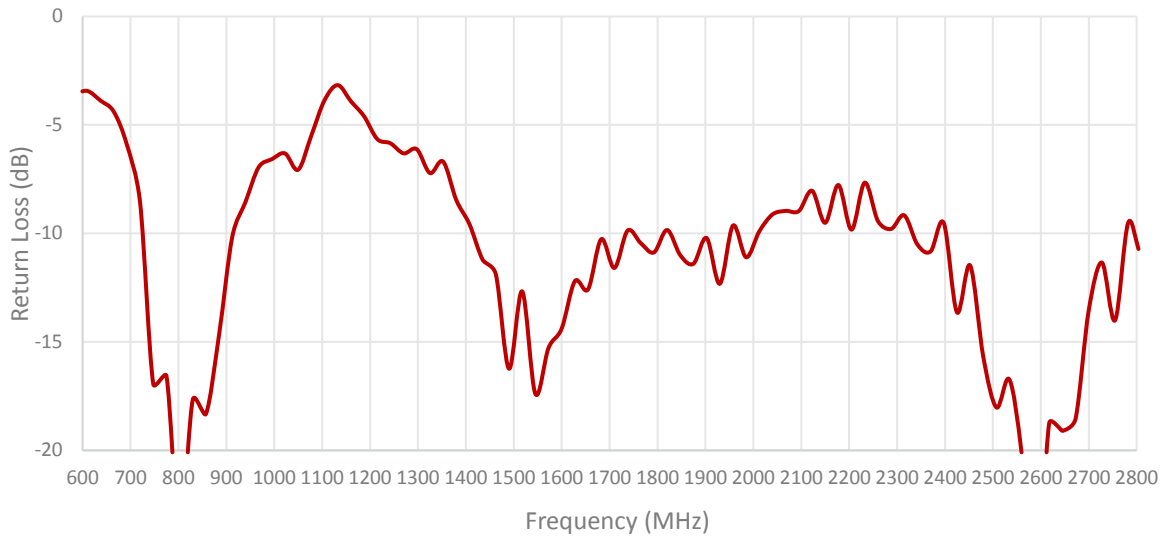

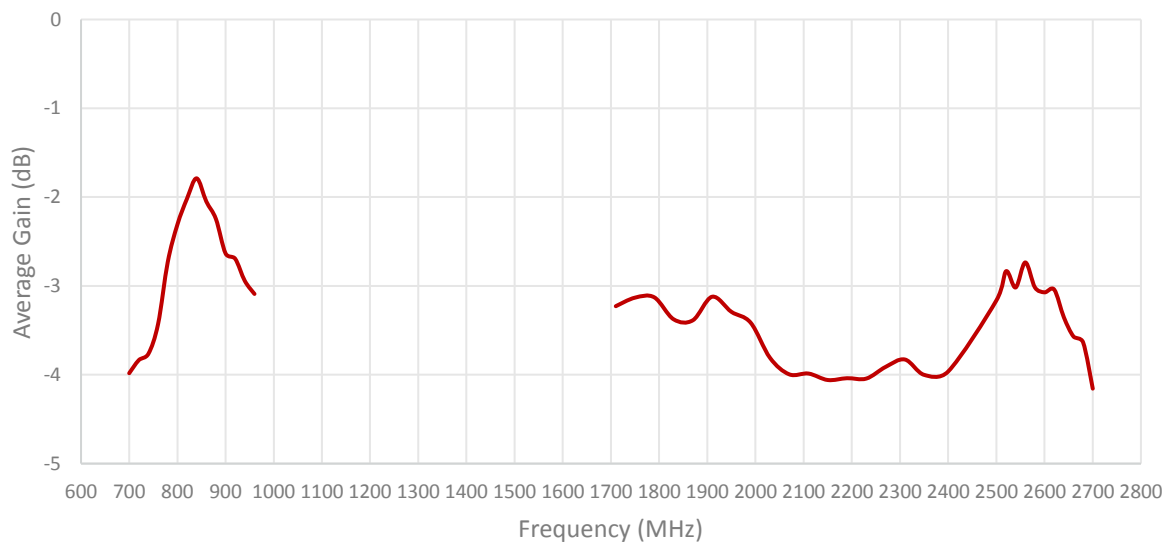
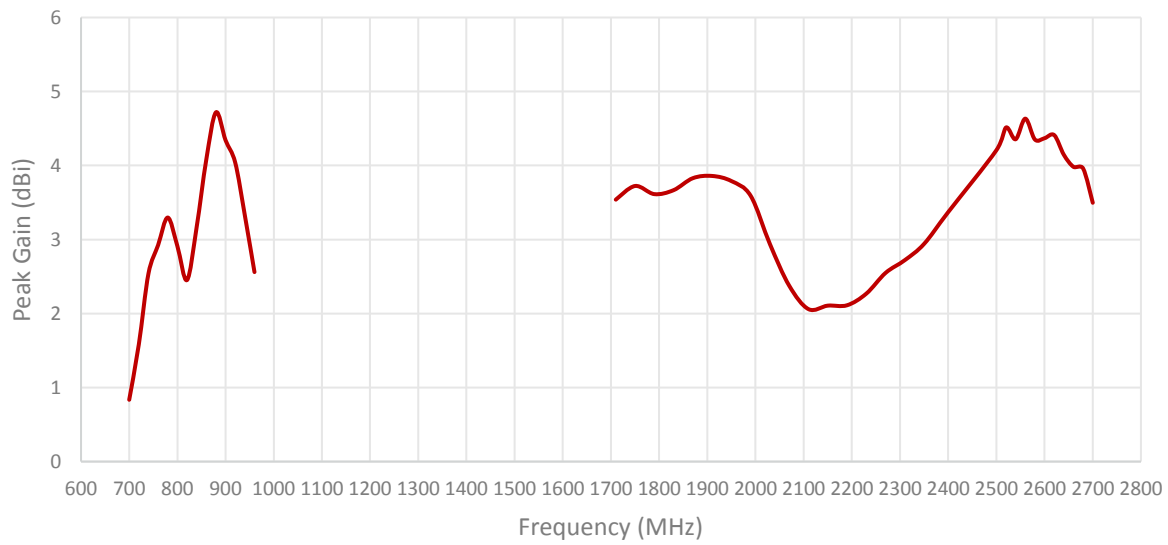
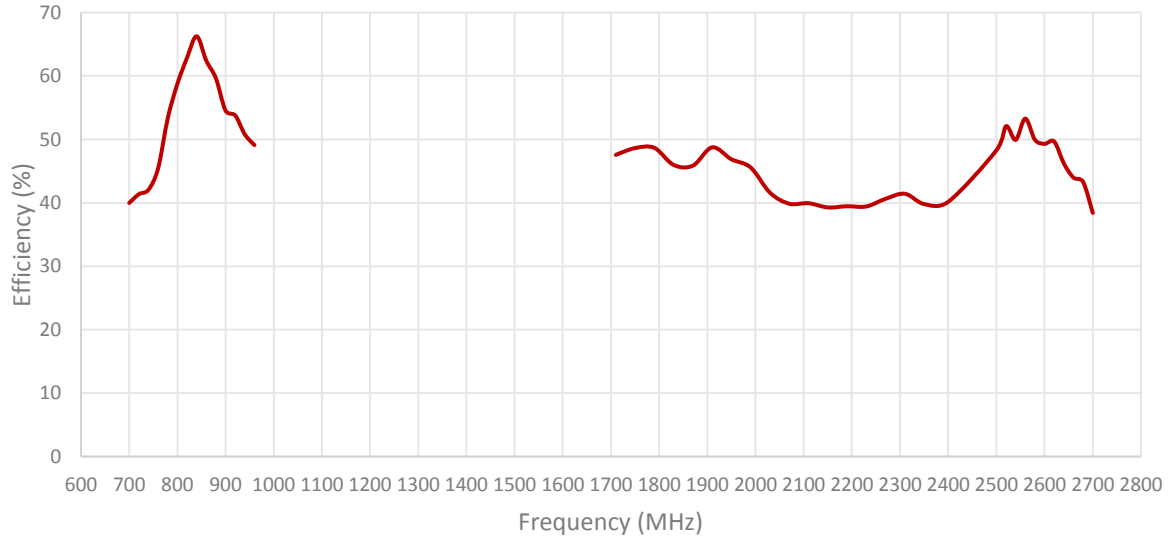

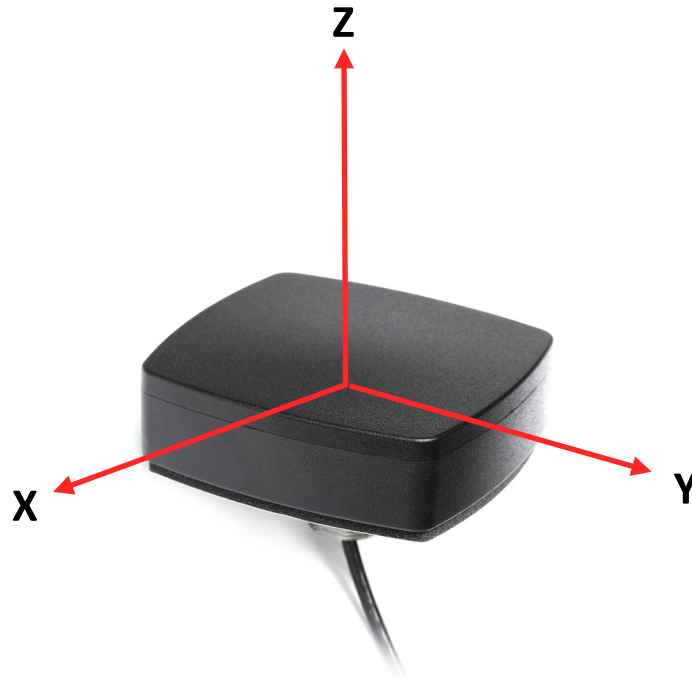

Radiation pattern reference

Table 1: CELLULAR/LTE

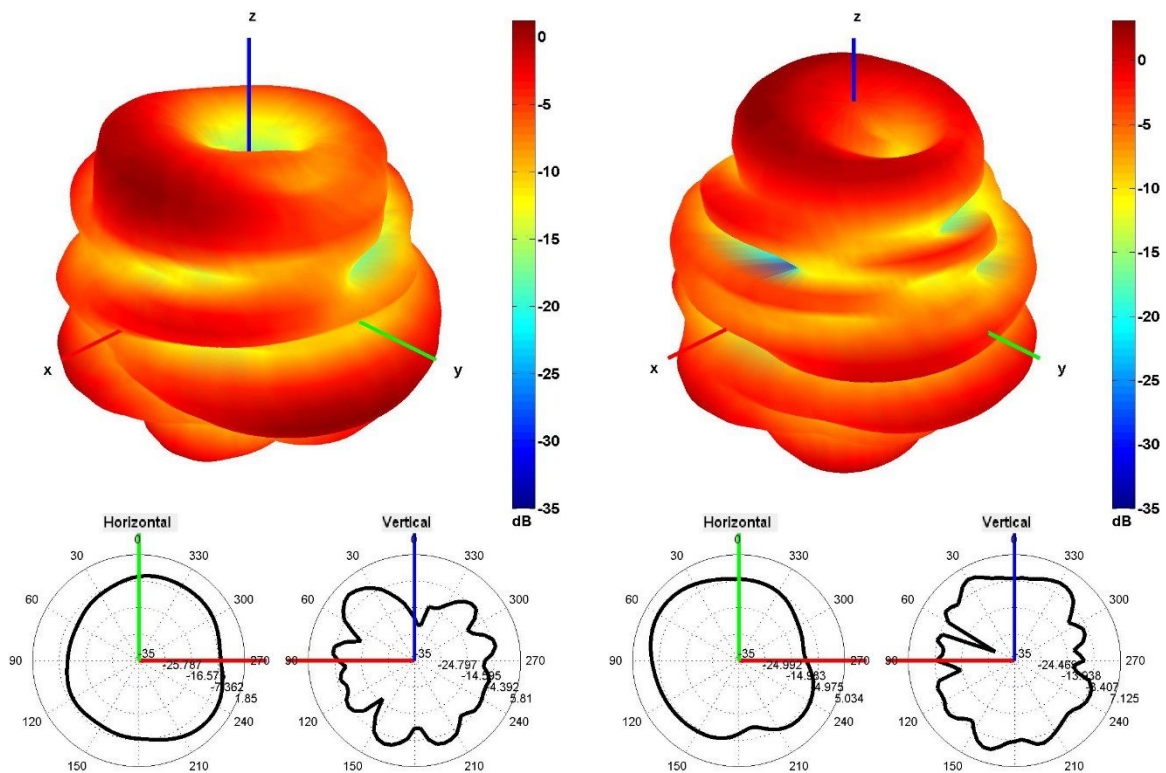

750 and 850 MHz Radiation pattern

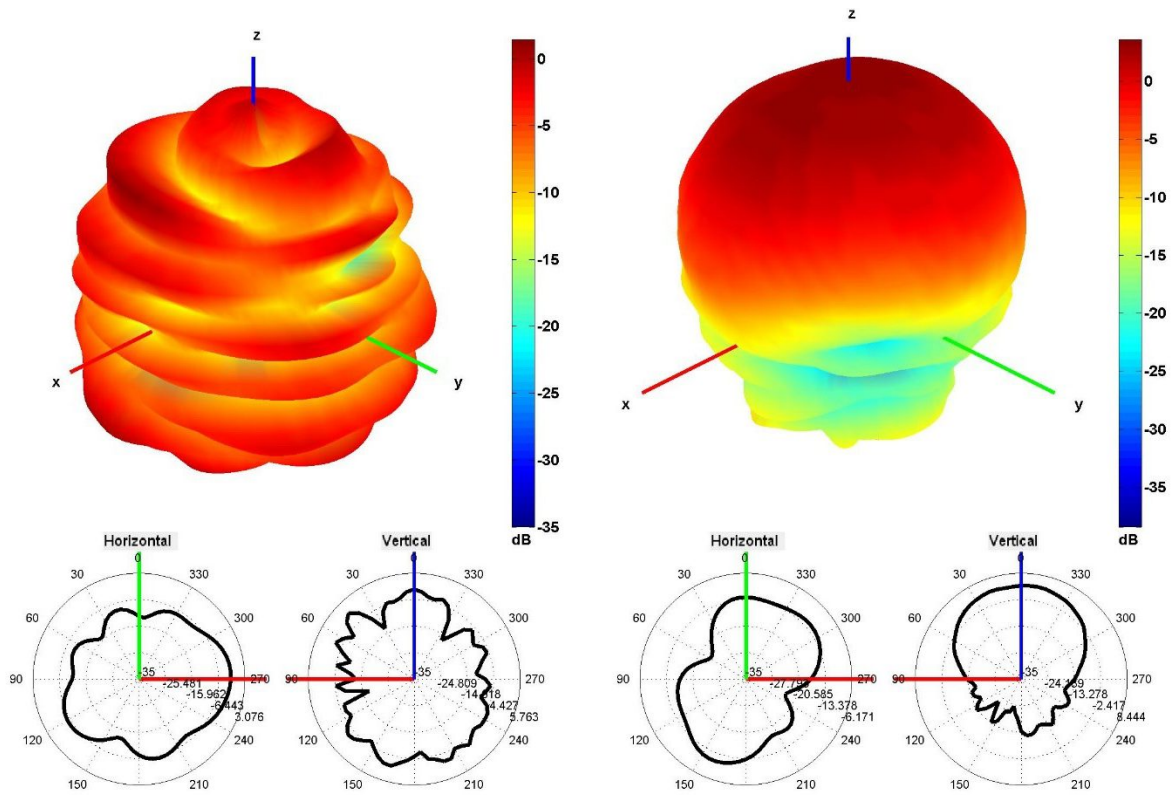

940 and 1750 MHz Radiation pattern

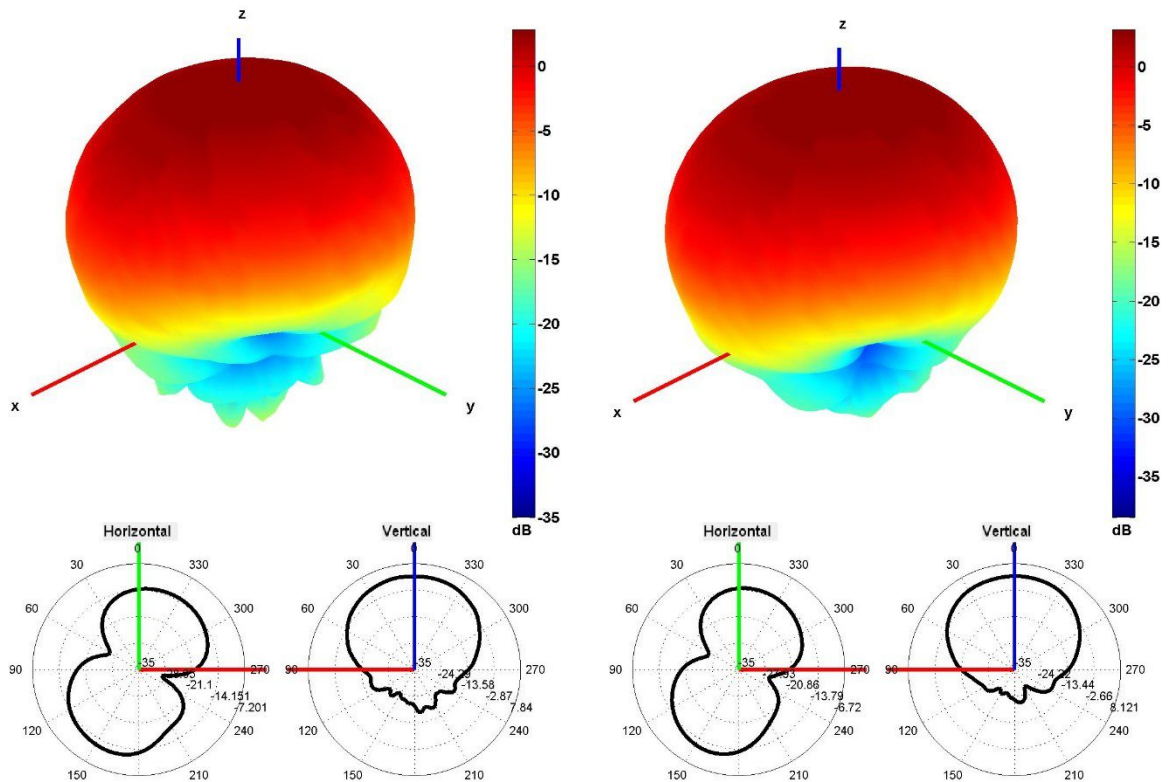

1850 and 1950 MHz Radiation pattern

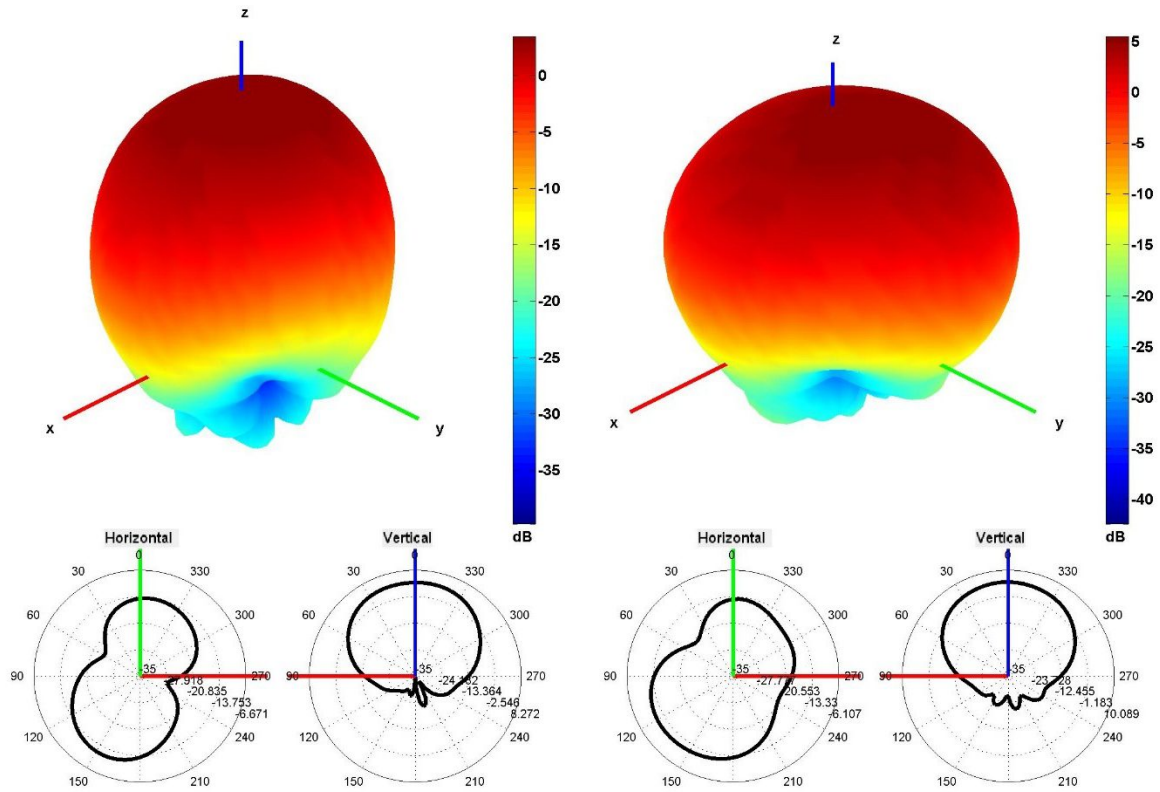

2100 and 2600 MHz Radiation pattern

## 4. Antenna drawings

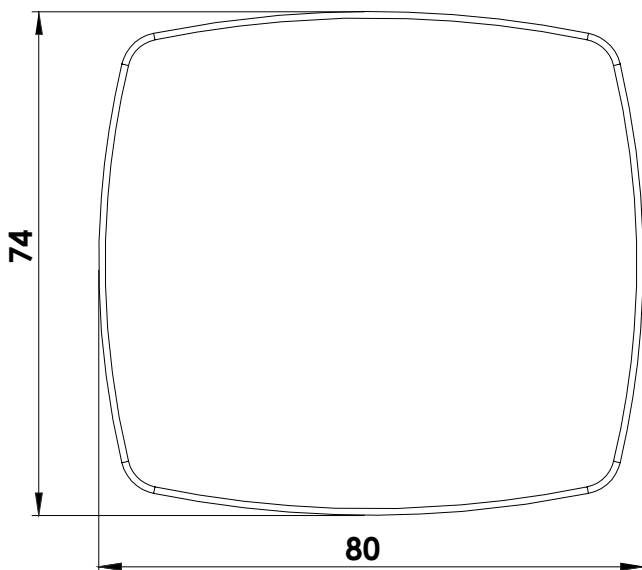
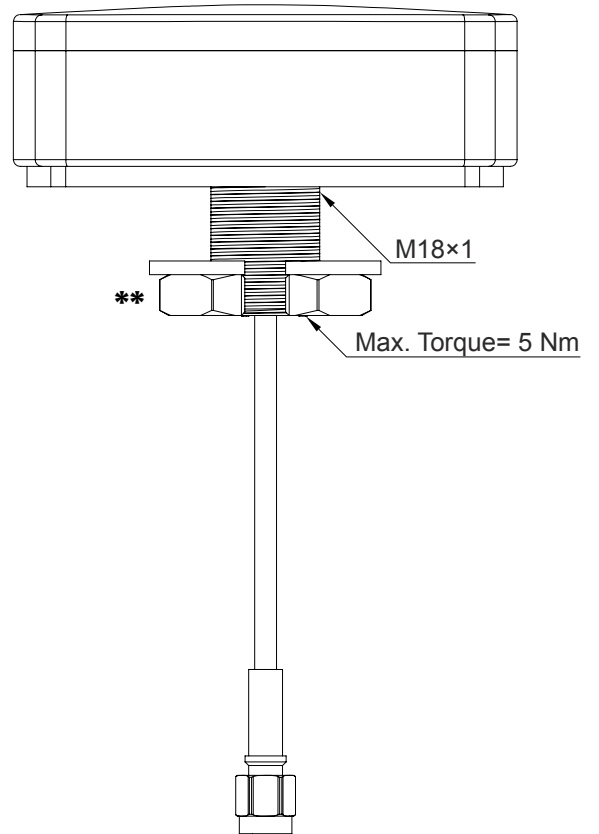
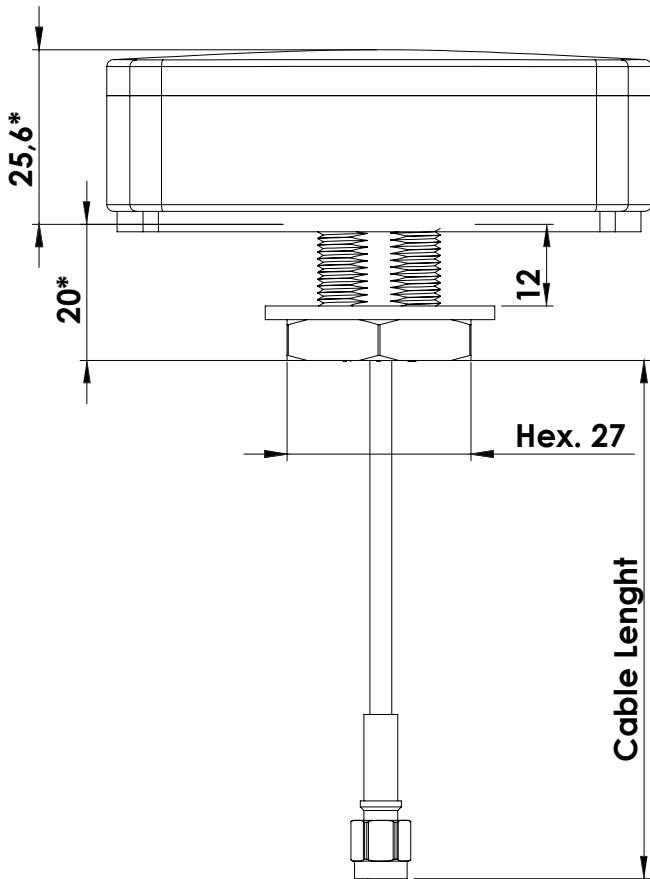

### Mounting hole

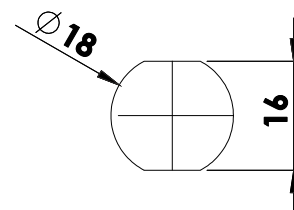

Max. mounting thickness 12mm  
 Note: Dimensions are in millimeters  
 \*Dimensions are after mounting  
 \*\*Max. Torque= 5 Nm



## 5. Antenna Images

