

- ◆ Compact universal power supply for uninterruptable 24 VDC output voltage
- ◆ Battery protection for over voltage, deep discharge, short circuit and reverse connection
- ◆ Alarm outputs for input, output and battery condition
- ◆ Remote On/Off for UPS function and power supply
- ◆ Controlled end of charge voltage by battery temperature sensor
- ◆ International safety approval package
- ◆ Suitable for various external 12 VDC lead acid batteries

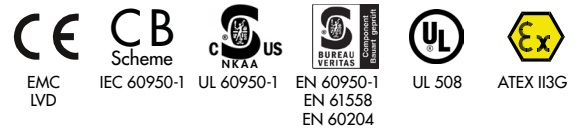

TSP-TS battery temperature sensor (10 kOhm NTC with 2m cable) optional

This power supply provides an integrated professional battery management system to charge and monitor an external lead-acid battery. The result is a complete DC-UPS system in a compact housing with no additional parts needed. The external connected 12 V battery will be charged and held in charged mode by the power supply. In the event of a mains power failure the battery will supply the output power until the battery is discharged. To avoid overcharging the battery, an external temperature sensor adjusts the battery voltage automatically to the required end of charge voltage. This can extend the battery life. The battery is protected against deep discharge. Mains power and battery status are monitored regularly and failures indicated by corresponding LED's and alarm outputs. The module also provides an external On/Off input to switch-off both, power supply and battery.

Models				
Order code	Input voltage range	Output current max.*	Output Power max.	Back up battery
TSPC 240-124 UPS	Low Line : 85 – 132 VAC High Line: 187 – 264 VAC	24 VDC / 12 A	240 W	12V lead acid battery (to purchase on local market, no TRACO POWER stocking item)

\* Maximum current at nominal Vout

## Input Specifications

Input voltage	<ul style="list-style-type: none"> <li>- nominal ranges</li> <li>- effective ranges</li> </ul>	100 – 120 / 220 – 240 VAC by selection switch 85 – 132 / 187 – 264 VAC (output current derating at low input voltage see page 6)
Input voltage frequency		47 – 63 Hz
Harmonic limits		EN 61000-3-2
Holdup time		10 ms min.
Inrush current		40 A
Recommended circuit breaker,		16.0 A max. characteristic B or C or slow blow fuse

## Output Specifications

Output voltage / current	<ul style="list-style-type: none"> <li>- normal mode</li> <li>- buffer mode</li> <li>- output power derating above 24 VDC</li> </ul>	24.0 – 26.0 VDC; 10 A (12 A in boost mode) 23.4 – 23.8 VDC; 10 A (12 A in boost mode) 5 %/V
Efficiency (load >50 % of I <sub>out</sub> max.)	<ul style="list-style-type: none"> <li>- normal mode</li> <li>- buffer mode</li> </ul>	88 – 91 % (battery charged) 90 – 92 %
Regulation	<ul style="list-style-type: none"> <li>- Input variation</li> <li>- Load variation (0–100 %)</li> </ul>	1 % max. 1 % max.
Ripple and Noise (20MHz bandwidth)		100 mVp-p max.
Overload protection		120 – 140 % of I <sub>out</sub> nom., constant current
Short circuit current		90 % of I <sub>out</sub> nom. (typ.), foldback
Output overvoltage protection		45 V
Overtemperature protection		switch off at overtemperature, automatic restart
Power back immunity		35 V (40 V for 1 sec.)
Max. capacitive load		unlimited

## General Specifications

Operating temperature	<ul style="list-style-type: none"> <li>- operation in normal &amp; buffer mode</li> <li>- normal mode boost output</li> <li>- buffer mode boost output</li> </ul>	-25°C to +70°C max. derating above +60°C : 2.5%/K -25°C to +60°C max. derating above +50°C : 1.67 %/K -25°C to +40°C max.
Storage temperature		-25°C to +85°C max.
Temperature coefficient		0.02 %/K
Cooling		convection cooling, no internal fan
Pollution degree		2
Humidity (non condensing)		95 % rel. H max.
Reliability, calculated MTBF at +25°C acc. to IEC 61709		> 1.1 Mio. h
Battery protection		against over voltage, deep discharge, overcharge, short circuit and reverse connection (built-in fuse)
Signals	<ul style="list-style-type: none"> <li>- Status</li> <li>- Trigger threshold:</li> <li>- Contact rating</li> </ul>	DC IN OK, DC OUT OK, BAT OK all relay contact closed and LED on at status OK 21.0 – 22.5 V 30 VDC / 1.0 A max. 60 VDC / 0.5 A max.

All specifications valid at nominal input voltage, full load and +25°C after warm-up time unless otherwise stated.

**General Specifications** (continued)

Battery charging current	0.8 – 1.2 A
Nominal battery voltage (at 25°C)	13.6 VDC (factory setting)
Battery voltage adjustment range	13.0 – 14.4 VDC
Battery resistance test	100mOhm min. (normal mode at 25°C)
Battery test current	2.5A / 60ms typ. (normal mode at 25°C)
Battery test interval (acc. to jumper setting)	15s or 10min
Battery warning	10.4 – 11.4 VDC (buffer mode only)
Battery disconnection	9.3 – 10.2 VDC (buffer mode only)
Battery remote Off	disconnects battery in buffer mode (see page 6 - connector)
Automatic battery temperature compensation range	-15°C – 50°C
Altitude during operation	2000 m
Isolation	according to IEC/EN 60950-1, UL 60950-1, UL 508
Safety standards	<ul style="list-style-type: none"> <li>- Information technology equipment</li> <li>- Industrial control equipment</li> <li>- Electrical equipment for machines</li> <li>- Electronic equipment for power installation</li> <li>- Safety of transformers</li> <li>- Control equipment for hazardous location</li> <li>- ATEX (for IP 54 enclosure)</li> <li>- Certification documents</li> </ul>
	IEC/EN 60950-1, UL 60950-1, CSA 22.2 No 60950-1-07 UL 508, CSA-C22.2 No.107 EN 60204-1 EN 50178 EN 61558-2-6, EN 61558-2-16 EN 60079-15 II3G EX nA IIC T4 certificate no. EPS 10 ATEX 1 269 X <a href="http://www.tracopower.com/overview/tspc-ups">www.tracopower.com/overview/tspc-ups</a>
Class of protection	safety class I (IEC 536)
Degree of protection	IP 20 (IEC/EN 60529)
Electromagnetic compatibility (EMC), Emissions	EN 61000-6-3, EN 61204-3
	<ul style="list-style-type: none"> <li>- Conducted RI suppression on input</li> <li>- Radiated RI suppression</li> </ul>
	EN 55011 class B, EN 55022 class B, EN 55011 class B, EN 55022 class B,
Electromagnetic compatibility (EMC), Immunity	EN 61000-6-2, EN 61204-3
	<ul style="list-style-type: none"> <li>- Electrostatic discharge (ESD)</li> <li>- Radiated RF field immunity</li> <li>- Electrical fast transient / burst immunity</li> <li>- Surge immunity</li> <li>- Immunity to conducted RF disturbances</li> <li>- Power frequency field immunity</li> <li>- Mains voltage dips and interruptions</li> </ul>
	IEC/EN 61000-4-2    4 kV / 8 kV    criteria B IEC/EN 61000-4-3    10 V / m    criteria A IEC/EN 61000-4-4    2 kV    criteria B IEC/EN 61000-4-5    1 kV / 2 kV    criteria B IEC/EN 61000-4-6    10 V    criteria A IEC/EN 61000-4-8    30 A / m    criteria A IEC/EN 61000-4-11    criteria A
Environment	<ul style="list-style-type: none"> <li>- Vibration acc. IEC 60068-2-6;</li> <li>- Shock acc. IEC 60068-2-27</li> </ul>
	3 axis, sine sweep, 10 – 55 Hz, 1 g, 1 oct/min 3 axis, 15 g half sine, 11 ms
Enclosure material	aluminium (chassis) / stainless steel (cover)
Mounting	<ul style="list-style-type: none"> <li>- DIN-rail mounting</li> </ul>
	for DIN-rails as per EN 50022-35x15/7.5 (snap-on with self-locking spring)
Environmental compliance	<ul style="list-style-type: none"> <li>- Reach</li> <li>- RoHS</li> </ul>
	<a href="http://www.tracopower.com/overview/tspc-ups">www.tracopower.com/overview/tspc-ups</a> RoHS directive 2011/65/EU
Connection	<ul style="list-style-type: none"> <li>- Input output battery</li> <li>- Signal &amp; control</li> </ul>
	screw terminal (plug included) detachable screw terminals (plugs included)

All specifications valid at nominal input voltage, full load and +25°C after warm-up time unless otherwise stated.

## Function Specification

### Function Diagram:

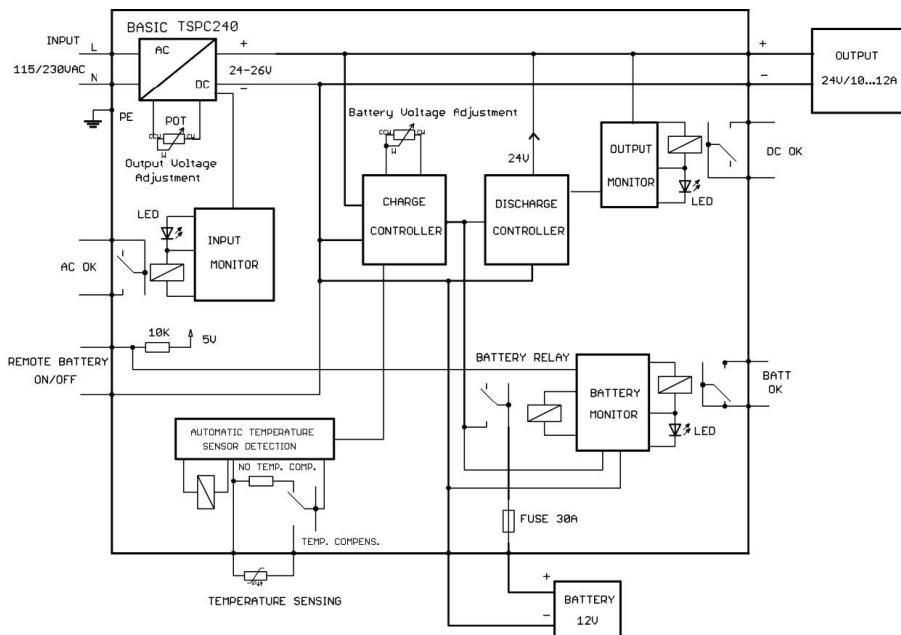

### General Description

This power supply is supplied by mains voltage and contains an integrated DC uninterruptible power supply feed by an external battery. It is designed to supply the applied load continuously and without interruption, even when the mains power fails. In this case, the energy is supplied from an external 12V battery to provide the required output voltage. The unit is designed to operate with lead-acid batteries.

### Operation

Before the first use, the AC input range should be set by the slide switch. During the normal operation, when the input AC voltage is present, the output DC voltage is delivered by internal AC/DC power supply.

In case of power failure the internal battery discharge regulator is activated. The output voltage will be still maintained at the reduced level of 23.6V (typically at  $V_{nom}$ ) without any interruptions. The battery discharge operation will continue until AC input voltage recovers.

If the input AC voltage does not recover, the battery voltage will continue to drop, while continuously delivering the output power at required voltage level. In order to prevent the deep discharge of the battery, which can lead to battery failure, the battery is disconnected at the deep discharge threshold. The BATT OK signal will be OFF when the battery voltage is approaching the disconnection voltage level. This can enable early warning of the system.

If the input AC is present at the right level, the battery is automatically charged to the set voltage level. This level is factory set for 25°C for lead-acid batteries. The user can change this voltage by using the built-in potentiometer. The adjustment can be made only if the battery is disconnected (after initial operation) to prevent from adjustments errors. The battery test interval should be set to 10 minutes (factory settings). If the battery is operating at a different ambient temperature (not 25°C), the user can adjust the set battery voltage to the required ambient temperature, as recommended by the battery manufacturer.

After adjustments – the battery should be re-connected. It is also possible to use the temperature compensation probe to automatically compensate the end battery charge voltage for any temperature changes. In this case, there is no need to change the potentiometer to compensate for a new ambient temperature.

The internal state of charge of the battery is tested at regular intervals with internal current pulse. The interval is factory set to 10 minutes. It can be changed to 15s for test purposes by changing the slide switch position on the front of the unit as indicated on the label. If the battery OK signal is OFF, even after prolonged charging, the battery pack needs replacement. The buffer function (during input power failure) can be disabled remotely, and the battery is disconnected. It can be achieved by pulling the Remote ON/OFF pin to GND (with contact relay or transistor).

**Function Specification (continued)**

**Signals**

Following signals are made available as LED indicators and corresponding isolated relay contacts:

- AC-OK                Indicates if the input AC voltage is present. During operation outside the DC specification (overload), at low input AC levels (below nominal range) it can be OFF. It will indicate that the battery operation has started in order to maintain the output voltage at 24V level.
  
- BATT-OK:           Indicates if the battery is charged properly and has low internal resistance. During battery discharge operation this signal monitors the battery voltage. If the battery voltage approaches the disconnection voltage – it is OFF. This enables early warnings of the system. The threshold of this signal is about 1V higher than the battery disconnection voltage.  
 Note that if the battery signal was OFF during the normal operation (when input voltage is present) – it will stay OFF during the battery discharge operation as well.
  
- DC-OUT-OK:        Indicates that the output voltage is higher than 82–90% of the nominal output voltage.

**Battery**

When the input AC voltage is present, the TSPC-240UPS unit will automatically charge the connected battery to a set end of battery charge voltage level, factory set for 25°C for lead-acid batteries, using a constant current charging method of 1A (typical). As the battery voltage approaches the end of battery charge voltage level, the current will decrease proportionally; this characteristic is shown in Fig 1. The user can adjust the set end of battery charge voltage level by means of the "Battery Voltage Adjust" potentiometer. The module also provides an input connector for a temperature compensation probe. If this probe is connected, the unit will automatically compensate the end of battery charge voltage level depending on the measured temperature. The connection of the temperature probe also negates the need to change the potentiometer to compensate for a new temperature. The battery end voltage compensation curve is shown in Fig. 2. (Applicable to factory setting of 13.6V/ 25°C)

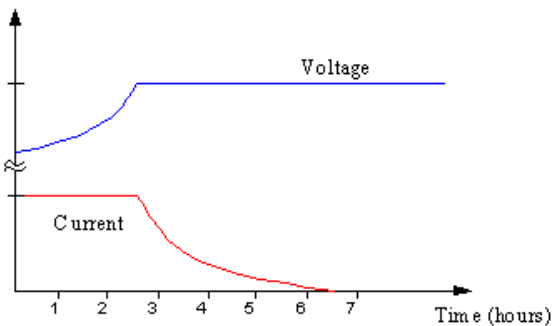

Figure 1

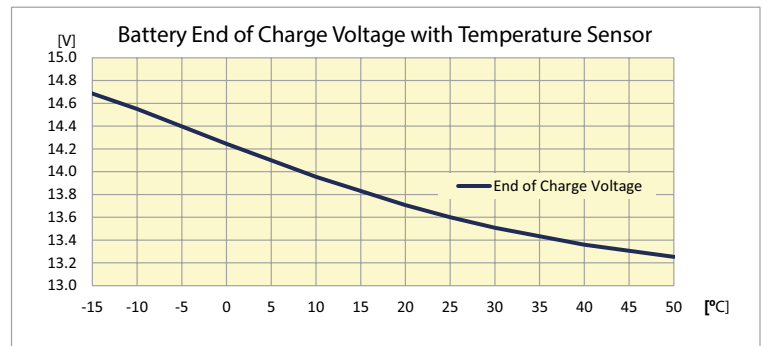

Figure 2

**Battery Protection**

The module protects the connected battery against short circuit and overload by the means of a built in 30A fuse. This fuse is a standard 30A blade type fuse, which is accessible from the front panel of the unit for ease of replacement should the fuse be damaged during operation.

It also prevents deep discharge of the battery by disconnecting the battery from the load once the voltage level of battery has dropped below a defined threshold. An early warning of this disconnection is given to the user by means of the BATT-OK signal (see chapter 2.6.2). The BATT-OK signal will switch off when the battery voltage is roughly 1V above the deep discharge threshold.

**Function Specification (continued)**

**Remote On/Off**

The TSPC-240UPS module provides a Battery Remote on/off input (2 pins on signalconnector); if this input is short circuited (switch closed in Fig. 3) the battery will be disconnected from the unit by means of an internal relay. A voltage of 0.5V or less across the Battery Remote on/off terminals will disconnect the battery from the unit. If the Battery Remote On/Off signal is set to off (short between pins) this will not affect the output of the unit in normal mode, however the battery will be disconnected, hence it will not charge. If the unit enters buffer mode while the Battery Remote On/Off signal is off, the battery will remain disconnected, hence no energy will be supplied to the load.

Battery State	Battery Remote On/Off Pins	Voltage
Connected	Open Circuit	5V
Disconnected	Short Circuit	< 0.5V

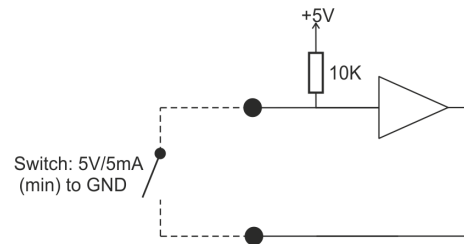

Figure 3

**Ambient temperature and power rating**

The module operates at temperatures between  $-10^{\circ}\text{C}$  and  $+60^{\circ}\text{C}$ , with a minimum start-up temperature of  $-25^{\circ}\text{C}$ . In normal mode the module can deliver full power up to  $60^{\circ}\text{C}$ . The boost current of 12A is available at ambient temperatures up to  $50^{\circ}\text{C}$  with a derating of  $1.67\%/^{\circ}\text{C}$  for temperatures above  $50^{\circ}\text{C}$ , as shown in Fig. 4. In buffer mode the module can deliver full power up to  $60^{\circ}\text{C}$  with the boost current of 12A available at ambient temperatures up to  $40^{\circ}\text{C}$  as shown in Fig. 5.

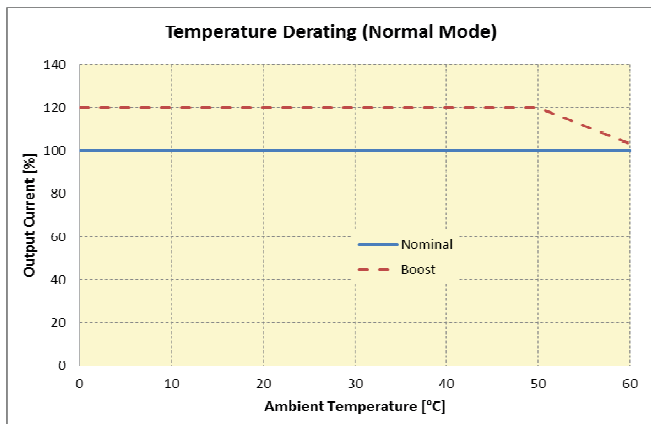

Figure 4

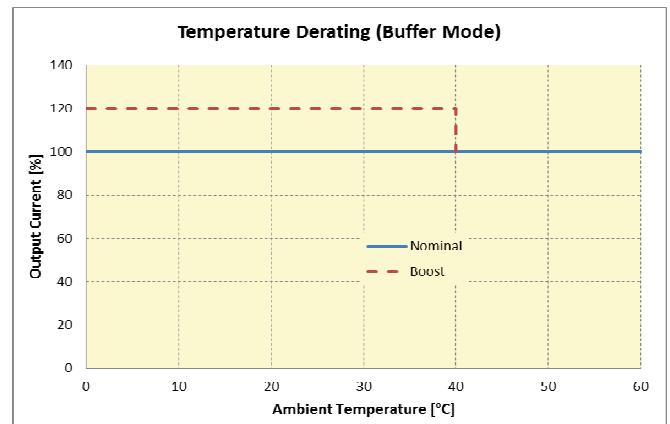

Figure 5

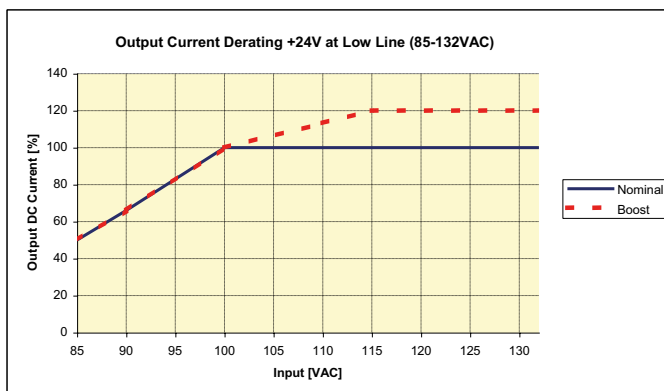

Figure 6

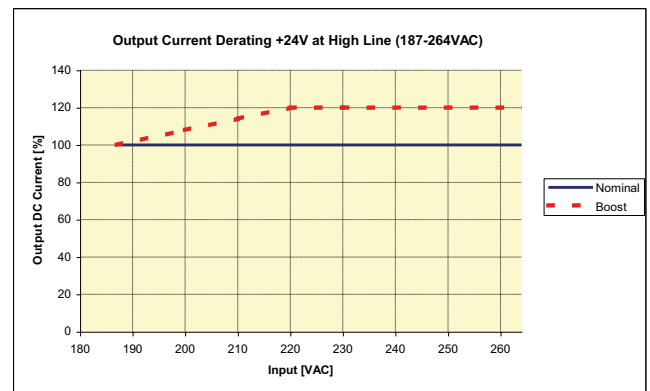
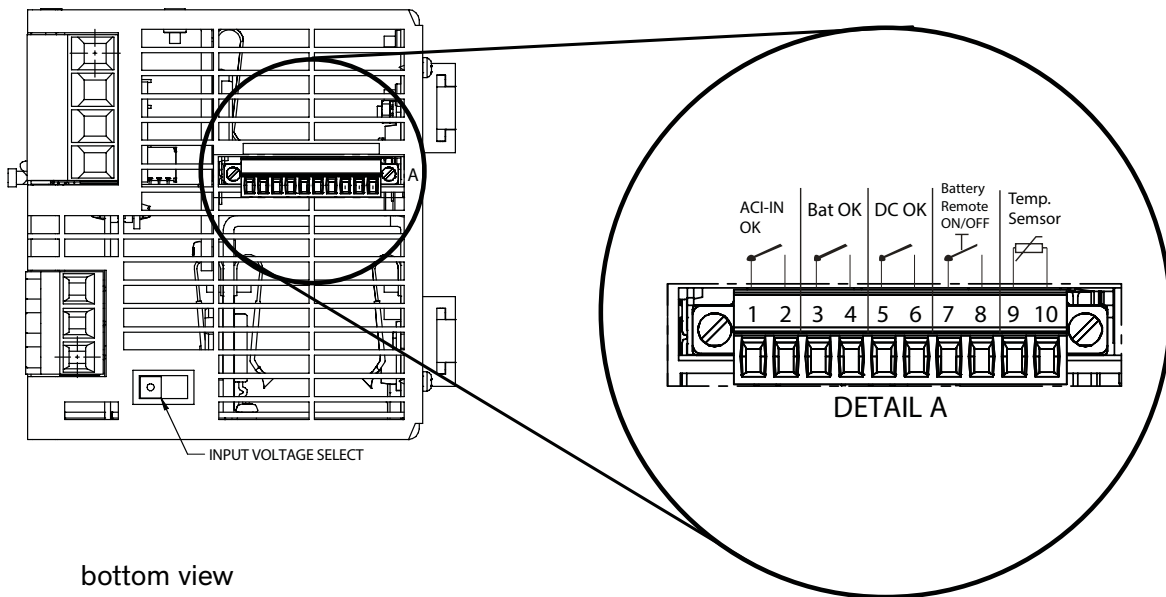

Figure 7

### Connector Position



### Outline Dimensions

