

Data sheet | Item number: 769-209/281-434

2-pin component carrier block; with 2 jumper positions; LED (red); 24 VDC;
for DIN-rail 35 x 15 and 35 x 7.5; gray

www.wago.com/769-209_281-434

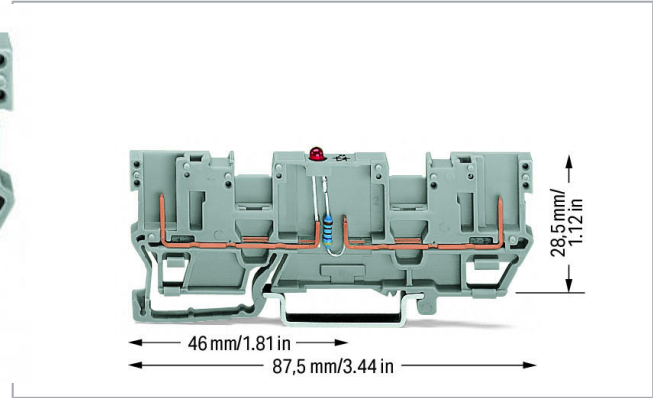
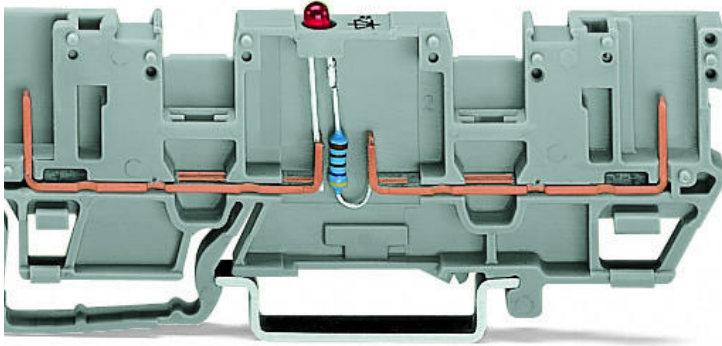

RoHS Compliant

[BOMcheck.net](https://www.bomcheck.net)

Color:

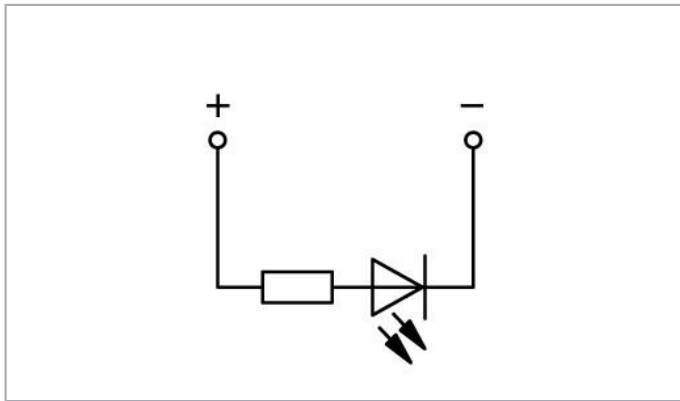

Data

Electrical data

Voltage type 1	DC
Nominal voltage	24 V

Ratings per IEC/EN

Rated current	0.025 A
---------------	---------

Subject to changes. Please also observe the further product documentation!

WAGO Kontakttechnik GmbH & Co. KG
Hansastr. 27
32423 Minden
Phone: +49571 887-0 | Fax: +49571 887-169
Email: info.de@wago.com | Web: www.wago.com

Do you have any questions about our products?
We are always happy to take your call at +49 (571) 887-44222.



Connection data

Total number of potentials	1
Number of levels	1
Wiring type	Front-entry wiring

Physical data

Width	5 mm / 0.197 inch
Height	87.5 mm / 3.445 inch

Mechanical data

Design	horizontal type
Mounting type	DIN-35 rail
Marking level	Center marking

Material data

Color	gray
Insulation material	Polyamide (PA66)
Fire load	0.159 MJ
Weight	7.6 g

Commercial data

Product Group	18 (X-COM-System)
Packaging type	BOX
Country of origin	DE
GTIN	4050821418443
Customs tariff number	85369010000

Approvals / Certificates

Country specific Approvals

Logo	Approval	Additional Approval Text	Certificate name
	CCA DEKRA Certification B.V.	EN 60947	NTR NL-7626
	CSA DEKRA Certification B.V.	C22.2 No. 158	1101144

Subject to changes. Please also observe the further product documentation!





KEMA/KEUR
DEKRA Certification B.V.

EN 60947

2190419.01





Ship Approvals

Logo	Approval	Additional Approval Text	Certificate name
	ABS American Bureau of Shipping	EN 60947	20- HG1941090- PDA
	DNV GL Det Norske Veritas, Germanischer Lloyd	-	TAE00001V2





Required accessories

End plate

	Item no.: 769-309 End and intermediate plate; 1.1 mm thick; gray	www.wago.com/769-309
	Item no.: 769-310 End and intermediate plate; 1.1 mm thick; orange	www.wago.com/769-310

Compatible products

check

















	Item no.: 210-137 Test plug; 2.3 mm Ø; with 500 mm cable; yellow	www.wago.com/210-137
	Item no.: 280-404 Test plug adapter; 5 mm wide; for test plug (2.3 mm Ø); suitable for 1.5 mm ² - 4 mm ² tbs; gray	www.wago.com/280-404
	Item no.: 280-418 Test plug module; modular; suitable for all WAGO 280 and 780 Series rail-mounted terminal blocks with jumper slots in the current bar; gray	www.wago.com/280-418
	Item no.: 280-419 Spacer module; modular; bridging commoned terminal blocks; gray	www.wago.com/280-419

Jumper

Subject to changes. Please also observe the further product documentation!

WAGO Kontakttechnik GmbH & Co. KG
Hansastr. 27
32423 Minden
Phone: +49571 887-0 | Fax: +49571 887-169
Email: info.de@wago.com | Web: www.wago.com

Do you have any questions about our products?
We are always happy to take your call at +49 (571) 887-44222.

	Item no.: 280-402 Jumper; insulated; gray	www.wago.com/280-402
	Item no.: 280-409 Jumper; insulated; gray	www.wago.com/280-409
	Item no.: 780-452 Staggered jumper; from 1 to 2; insulated; gray	www.wago.com/780-452
	Item no.: 780-453 Staggered jumper; from 1 to 3; insulated; gray	www.wago.com/780-453
	Item no.: 780-454 Staggered jumper; from 1 to 4; insulated; gray	www.wago.com/780-454
	Item no.: 780-455 Staggered jumper; from 1 to 5; insulated; gray	www.wago.com/780-455
	Item no.: 780-456 Staggered jumper; from 1 to 6; insulated; gray	www.wago.com/780-456
	Item no.: 780-457 Staggered jumper; from 1 to 7; insulated; gray	www.wago.com/780-457
	Item no.: 780-458 Staggered jumper; from 1 to 8; insulated; gray	www.wago.com/780-458
Female plug		
	Item no.: 769-101 1-conductor female plug; 4 mm ² ; 1-pole; 4,00 mm ² ; gray	www.wago.com/769-101
	Item no.: 769-101/000-006 1-conductor female plug; 4 mm ² ; 1-pole; 4,00 mm ² ; blue	www.wago.com/769-101/000-006
	Item no.: 769-101/000-016 1-conductor female plug; 4 mm ² ; 1-pole; 4,00 mm ² ; green-yellow	www.wago.com/769-101/000-016
	Item no.: 769-101/022-000 1-conductor female plug; angled; 4 mm ² ; 1-pole; 4,00 mm ² ; gray	www.wago.com/769-101/022-000
	Item no.: 769-101/022-016 1-conductor female plug; angled; 4 mm ² ; 1-pole; 4,00 mm ² ; green-yellow	www.wago.com/769-101/022-016
	Item no.: 769-102 1-conductor female plug; 4 mm ² ; 2-pole; 4,00 mm ² ; gray	www.wago.com/769-102
	Item no.: 769-102/000-006 1-conductor female plug; 4 mm ² ; 2-pole; 4,00 mm ² ; blue	www.wago.com/769-102/000-006

Subject to changes. Please also observe the further product documentation!



Item no.: 769-102/000-036
1-conductor female plug; 4 mm²; 2-pole; 4,00 mm²; gray, green-yellow

www.wago.com/769-102/000-036



Item no.: 769-102/000-037
1-conductor female plug; 4 mm²; 2-pole; 4,00 mm²; green-yellow, gray

www.wago.com/769-102/000-037



Item no.: 769-102/022-000
1-conductor female plug; angled; 4 mm²; 2-pole; 4,00 mm²; gray

www.wago.com/769-102/022-000



Item no.: 769-103
1-conductor female plug; 4 mm²; 3-pole; 4,00 mm²; gray

www.wago.com/769-103



Item no.: 769-103/000-006
1-conductor female plug; 4 mm²; 3-pole; 4,00 mm²; blue

www.wago.com/769-103/000-006



Item no.: 769-103/000-036
1-conductor female plug; 4 mm²; 3-pole; 4,00 mm²; gray, green-yellow

www.wago.com/769-103/000-036



Item no.: 769-103/000-037
1-conductor female plug; 4 mm²; 3-pole; 4,00 mm²; green-yellow, gray

www.wago.com/769-103/000-037



Item no.: 769-103/000-038
1-conductor female plug; 4 mm²; 3-pole; 4,00 mm²; gray, blue, green-yellow

www.wago.com/769-103/000-038



Item no.: 769-103/000-039
1-conductor female plug; 4 mm²; 3-pole; 4,00 mm²; green-yellow, blue, gray

www.wago.com/769-103/000-039



Item no.: 769-103/022-000
1-conductor female plug; angled; 4 mm²; 3-pole; 4,00 mm²; gray

www.wago.com/769-103/022-000



Item no.: 769-104
1-conductor female plug; 4 mm²; 4-pole; 4,00 mm²; gray

www.wago.com/769-104



Item no.: 769-104/000-006
1-conductor female plug; 4 mm²; 4-pole; 4,00 mm²; blue

www.wago.com/769-104/000-006



Item no.: 769-104/000-036
1-conductor female plug; 4 mm²; 4-pole; 4,00 mm²; gray, green-yellow

www.wago.com/769-104/000-036



Item no.: 769-104/000-037
1-conductor female plug; 4 mm²; 4-pole; 4,00 mm²; green-yellow, gray

www.wago.com/769-104/000-037

Subject to changes. Please also observe the further product documentation!



Item no.: 769-104/000-038

1-conductor female plug; 4 mm²; 4-pole; 4,00 mm²; gray, blue, green-yellow

www.wago.com/769-104/000-038



Item no.: 769-104/000-039

1-conductor female plug; 4 mm²; 4-pole; 4,00 mm²; green-yellow, blue, gray

www.wago.com/769-104/000-039



Item no.: 769-104/022-000

1-conductor female plug; angled; 4 mm²; 4-pole; 4,00 mm²; gray

www.wago.com/769-104/022-000



Item no.: 769-105

1-conductor female plug; 4 mm²; 5-pole; 4,00 mm²; gray

www.wago.com/769-105



Item no.: 769-105/000-006

1-conductor female plug; 4 mm²; 5-pole; 4,00 mm²; blue

www.wago.com/769-105/000-006



Item no.: 769-105/000-036

1-conductor female plug; 4 mm²; 5-pole; 4,00 mm²; gray, green-yellow

www.wago.com/769-105/000-036



Item no.: 769-105/000-037

1-conductor female plug; 4 mm²; 5-pole; 4,00 mm²; green-yellow, gray

www.wago.com/769-105/000-037



Item no.: 769-105/000-038

1-conductor female plug; 4 mm²; 5-pole; 4,00 mm²; gray, blue, green-yellow

www.wago.com/769-105/000-038



Item no.: 769-105/000-039

1-conductor female plug; 4 mm²; 5-pole; 4,00 mm²; green-yellow, blue, gray

www.wago.com/769-105/000-039



Item no.: 769-105/022-000

1-conductor female plug; angled; 4 mm²; 5-pole; 4,00 mm²; gray

www.wago.com/769-105/022-000



Item no.: 769-106

1-conductor female plug; 4 mm²; 6-pole; 4,00 mm²; gray

www.wago.com/769-106



Item no.: 769-106/000-006

1-conductor female plug; 4 mm²; 6-pole; 4,00 mm²; blue

www.wago.com/769-106/000-006



Item no.: 769-106/000-036

1-conductor female plug; 4 mm²; 6-pole; 4,00 mm²; gray, green-yellow

www.wago.com/769-106/000-036



Item no.: 769-106/000-037

1-conductor female plug; 4 mm²; 6-pole; 4,00 mm²; green-yellow, gray

www.wago.com/769-106/000-037

Subject to changes. Please also observe the further product documentation!



Item no.: 769-106/000-038

1-conductor female plug; 4 mm²; 6-pole; 4,00 mm²; gray, blue, green-yellow

www.wago.com/769-106/000-038



Item no.: 769-106/000-039

1-conductor female plug; 4 mm²; 6-pole; 4,00 mm²; green-yellow, blue, gray

www.wago.com/769-106/000-039



Item no.: 769-106/022-000

1-conductor female plug; angled; 4 mm²; 6-pole; 4,00 mm²; gray

www.wago.com/769-106/022-000



Item no.: 769-107

1-conductor female plug; 4 mm²; 7-pole; 4,00 mm²; gray

www.wago.com/769-107



Item no.: 769-107/000-006

1-conductor female plug; 4 mm²; 7-pole; 4,00 mm²; blue

www.wago.com/769-107/000-006



Item no.: 769-107/000-036

1-conductor female plug; 4 mm²; 7-pole; 4,00 mm²; gray, green-yellow

www.wago.com/769-107/000-036



Item no.: 769-107/000-037

1-conductor female plug; 4 mm²; 7-pole; 4,00 mm²; green-yellow, gray

www.wago.com/769-107/000-037



Item no.: 769-107/000-038

1-conductor female plug; 4 mm²; 7-pole; 4,00 mm²; gray, blue, green-yellow

www.wago.com/769-107/000-038



Item no.: 769-107/000-039

1-conductor female plug; 4 mm²; 7-pole; 4,00 mm²; green-yellow, blue, gray

www.wago.com/769-107/000-039



Item no.: 769-107/022-000

1-conductor female plug; angled; 4 mm²; 7-pole; 4,00 mm²; gray

www.wago.com/769-107/022-000



Item no.: 769-108

1-conductor female plug; 4 mm²; 8-pole; 4,00 mm²; gray

www.wago.com/769-108



Item no.: 769-108/000-006

1-conductor female plug; 4 mm²; 8-pole; 4,00 mm²; blue

www.wago.com/769-108/000-006



Item no.: 769-108/000-036

1-conductor female plug; 4 mm²; 8-pole; 4,00 mm²; gray, green-yellow

www.wago.com/769-108/000-036

















Item no.: 769-108/000-037

1-conductor female plug; 4 mm²; 8-pole; 4,00 mm²; green-yellow, gray

www.wago.com/769-108/000-037

Subject to changes. Please also observe the further product documentation!

	Item no.: 769-108/000-038 1-conductor female plug; 4 mm ² ; 8-pole; 4,00 mm ² ; gray, blue, green-yellow	www.wago.com/769-108/000-038
	Item no.: 769-108/000-039 1-conductor female plug; 4 mm ² ; 8-pole; 4,00 mm ² ; green-yellow, blue, gray	www.wago.com/769-108/000-039
	Item no.: 769-108/022-000 1-conductor female plug; angled; 4 mm ² ; 8-pole; 4,00 mm ² ; gray	www.wago.com/769-108/022-000
	Item no.: 769-109 1-conductor female plug; 4 mm ² ; 9-pole; 4,00 mm ² ; gray	www.wago.com/769-109
	Item no.: 769-109/000-006 1-conductor female plug; 4 mm ² ; 9-pole; 4,00 mm ² ; blue	www.wago.com/769-109/000-006
	Item no.: 769-109/000-036 1-conductor female plug; 4 mm ² ; 9-pole; 4,00 mm ² ; gray, green-yellow	www.wago.com/769-109/000-036
	Item no.: 769-109/000-037 1-conductor female plug; 4 mm ² ; 9-pole; 4,00 mm ² ; green-yellow, gray	www.wago.com/769-109/000-037
	Item no.: 769-109/000-038 1-conductor female plug; 4 mm ² ; 9-pole; 4,00 mm ² ; gray, blue, green-yellow	www.wago.com/769-109/000-038
	Item no.: 769-109/000-039 1-conductor female plug; 4 mm ² ; 9-pole; 4,00 mm ² ; green-yellow, blue, gray	www.wago.com/769-109/000-039
	Item no.: 769-109/022-000 1-conductor female plug; angled; 4 mm ² ; 9-pole; 4,00 mm ² ; gray	www.wago.com/769-109/022-000
	Item no.: 769-110 1-conductor female plug; 4 mm ² ; 10-pole; 4,00 mm ² ; gray	www.wago.com/769-110
	Item no.: 769-110/000-006 1-conductor female plug; 4 mm ² ; 10-pole; 4,00 mm ² ; blue	www.wago.com/769-110/000-006
	Item no.: 769-110/000-036 1-conductor female plug; 4 mm ² ; 10-pole; 4,00 mm ² ; gray, green-yellow	www.wago.com/769-110/000-036
	Item no.: 769-110/000-037 1-conductor female plug; 4 mm ² ; 10-pole; 4,00 mm ² ; green-yellow, gray	www.wago.com/769-110/000-037

Subject to changes. Please also observe the further product documentation!



Item no.: 769-110/000-038

1-conductor female plug; 4 mm²; 10-pole; 4,00 mm²; gray, blue, green-yellow

www.wago.com/769-110/000-038



Item no.: 769-110/000-039

1-conductor female plug; 4 mm²; 10-pole; 4,00 mm²; green-yellow, blue, gray

www.wago.com/769-110/000-039



Item no.: 769-110/022-000

1-conductor female plug; angled; 4 mm²; 10-pole; 4,00 mm²; gray

www.wago.com/769-110/022-000



Item no.: 769-111

1-conductor female plug; 4 mm²; 11-pole; 4,00 mm²; gray

www.wago.com/769-111



Item no.: 769-111/000-006

1-conductor female plug; 4 mm²; 11-pole; 4,00 mm²; blue

www.wago.com/769-111/000-006



Item no.: 769-111/000-036

1-conductor female plug; 4 mm²; 11-pole; 4,00 mm²; gray, green-yellow

www.wago.com/769-111/000-036



Item no.: 769-111/000-037

1-conductor female plug; 4 mm²; 11-pole; 4,00 mm²; green-yellow, gray

www.wago.com/769-111/000-037



Item no.: 769-111/000-038

1-conductor female plug; 4 mm²; 11-pole; 4,00 mm²; gray, blue, green-yellow

www.wago.com/769-111/000-038



Item no.: 769-111/000-039

1-conductor female plug; 4 mm²; 11-pole; 4,00 mm²; green-yellow, blue, gray

www.wago.com/769-111/000-039



Item no.: 769-111/022-000

1-conductor female plug; angled; 4 mm²; 11-pole; 4,00 mm²; gray

www.wago.com/769-111/022-000



Item no.: 769-112

1-conductor female plug; 4 mm²; 12-pole; 4,00 mm²; gray

www.wago.com/769-112



Item no.: 769-112/000-006

1-conductor female plug; 4 mm²; 12-pole; 4,00 mm²; blue

www.wago.com/769-112/000-006



Item no.: 769-112/000-036

1-conductor female plug; 4 mm²; 12-pole; 4,00 mm²; gray, green-yellow

www.wago.com/769-112/000-036



Item no.: 769-112/000-037

1-conductor female plug; 4 mm²; 12-pole; 4,00 mm²; green-yellow, gray

www.wago.com/769-112/000-037

Subject to changes. Please also observe the further product documentation!

WAGO Kontakttechnik GmbH & Co. KG

Hansastr. 27

32423 Minden

Phone: +49571 887-0 | Fax: +49571 887-169

Email: info.de@wago.com | Web: www.wago.com

Do you have any questions about our products?

We are always happy to take your call at +49 (571) 887-44222.



Item no.: 769-112/000-038

1-conductor female plug; 4 mm²; 12-pole; 4,00 mm²; gray, blue, green-yellow

www.wago.com/769-112/000-038



Item no.: 769-112/000-039

1-conductor female plug; 4 mm²; 12-pole; 4,00 mm²; green-yellow, blue, gray

www.wago.com/769-112/000-039



Item no.: 769-112/022-000

1-conductor female plug; angled; 4 mm²; 12-pole; 4,00 mm²; gray

www.wago.com/769-112/022-000



Item no.: 769-113

1-conductor female plug; 4 mm²; 13-pole; 4,00 mm²; gray

www.wago.com/769-113



Item no.: 769-113/000-036

1-conductor female plug; 4 mm²; 13-pole; 4,00 mm²; gray, green-yellow

www.wago.com/769-113/000-036



Item no.: 769-113/000-037

1-conductor female plug; 4 mm²; 13-pole; 4,00 mm²; green-yellow, gray

www.wago.com/769-113/000-037



Item no.: 769-113/000-038

1-conductor female plug; 4 mm²; 13-pole; 4,00 mm²; gray, blue, green-yellow

www.wago.com/769-113/000-038



Item no.: 769-113/000-039

1-conductor female plug; 4 mm²; 13-pole; 4,00 mm²; green-yellow, blue, gray

www.wago.com/769-113/000-039



Item no.: 769-113/022-000

1-conductor female plug; angled; 4 mm²; 13-pole; 4,00 mm²; gray

www.wago.com/769-113/022-000



Item no.: 769-114

1-conductor female plug; 4 mm²; 14-pole; 4,00 mm²; gray

www.wago.com/769-114



Item no.: 769-114/000-006

1-conductor female plug; 4 mm²; 14-pole; 4,00 mm²; blue

www.wago.com/769-114/000-006



Item no.: 769-114/000-036

1-conductor female plug; 4 mm²; 14-pole; 4,00 mm²; gray, green-yellow

www.wago.com/769-114/000-036



Item no.: 769-114/000-037

1-conductor female plug; 4 mm²; 14-pole; 4,00 mm²; green-yellow, gray

www.wago.com/769-114/000-037



Item no.: 769-114/000-038

1-conductor female plug; 4 mm²; 14-pole; 4,00 mm²; gray, blue, green-yellow

www.wago.com/769-114/000-038

Subject to changes. Please also observe the further product documentation!

WAGO Kontakttechnik GmbH & Co. KG

Hansastr. 27

32423 Minden

Phone: +49571 887-0 | Fax: +49571 887-169

Email: info.de@wago.com | Web: www.wago.com

Do you have any questions about our products?

We are always happy to take your call at +49 (571) 887-44222.



Item no.: 769-114/000-039

1-conductor female plug; 4 mm²; 14-pole; 4,00 mm²; green-yellow, blue, gray

www.wago.com/769-114/000-039



Item no.: 769-114/022-000

1-conductor female plug; angled; 4 mm²; 14-pole; 4,00 mm²; gray

www.wago.com/769-114/022-000



Item no.: 769-115

1-conductor female plug; 4 mm²; 15-pole; 4,00 mm²; gray

www.wago.com/769-115



Item no.: 769-115/000-036

1-conductor female plug; 4 mm²; 15-pole; 4,00 mm²; gray, green-yellow

www.wago.com/769-115/000-036



Item no.: 769-115/000-037

1-conductor female plug; 4 mm²; 15-pole; 4,00 mm²; green-yellow, gray

www.wago.com/769-115/000-037



Item no.: 769-115/000-038

1-conductor female plug; 4 mm²; 15-pole; 4,00 mm²; gray, blue, green-yellow

www.wago.com/769-115/000-038



Item no.: 769-115/000-039

1-conductor female plug; 4 mm²; 15-pole; 4,00 mm²; green-yellow, blue, gray

www.wago.com/769-115/000-039



Item no.: 769-115/022-000

1-conductor female plug; angled; 4 mm²; 15-pole; 4,00 mm²; gray

www.wago.com/769-115/022-000



Item no.: 769-121

2-conductor female connector; 4 mm²; 1-pole; 4,00 mm²; gray

www.wago.com/769-121



Item no.: 769-121/000-016

2-conductor female connector; 4 mm²; 1-pole; 4,00 mm²; green-yellow

www.wago.com/769-121/000-016



Item no.: 769-122

2-conductor female connector; 4 mm²; 2-pole; 4,00 mm²; gray

www.wago.com/769-122



Item no.: 769-123

2-conductor female connector; 4 mm²; 3-pole; 4,00 mm²; gray

www.wago.com/769-123



Item no.: 769-124

2-conductor female connector; 4 mm²; 4-pole; 4,00 mm²; gray

www.wago.com/769-124



Item no.: 769-125

2-conductor female connector; 4 mm²; 5-pole; 4,00 mm²; gray

www.wago.com/769-125



Item no.: 769-126

2-conductor female connector; 4 mm²; 6-pole; 4,00 mm²; gray

www.wago.com/769-126

Subject to changes. Please also observe the further product documentation!

WAGO Kontakttechnik GmbH & Co. KG

Hansastr. 27

















32423 Minden

Phone: +49571 887-0 | Fax: +49571 887-169















Email: info.de@wago.com | Web: www.wago.com

Do you have any questions about our products?

We are always happy to take your call at +49 (571) 887-44222.

	Item no.: 769-127 2-conductor female connector; 4 mm ² ; 7-pole; 4,00 mm ² ; gray	www.wago.com/769-127
	Item no.: 769-128 2-conductor female connector; 4 mm ² ; 8-pole; 4,00 mm ² ; gray	www.wago.com/769-128
	Item no.: 769-129 2-conductor female connector; 4 mm ² ; 9-pole; 4,00 mm ² ; gray	www.wago.com/769-129
	Item no.: 769-130 2-conductor female connector; 4 mm ² ; 10-pole; 4,00 mm ² ; gray	www.wago.com/769-130
	Item no.: 769-131 2-conductor female connector; 4 mm ² ; 11-pole; 4,00 mm ² ; gray	www.wago.com/769-131
	Item no.: 769-132 2-conductor female connector; 4 mm ² ; 12-pole; 4,00 mm ² ; gray	www.wago.com/769-132
	Item no.: 769-133 2-conductor female connector; 4 mm ² ; 13-pole; 4,00 mm ² ; gray	www.wago.com/769-133
	Item no.: 769-134 2-conductor female connector; 4 mm ² ; 14-pole; 4,00 mm ² ; gray	www.wago.com/769-134
	Item no.: 769-135 2-conductor female connector; 4 mm ² ; 15-pole; 4,00 mm ² ; gray	www.wago.com/769-135
	Item no.: 769-501 Start module for 1-conductor female connector; with integrated end plate; 4 mm ² ; 1-pole; 4,00 mm ² ; gray	www.wago.com/769-501
	Item no.: 769-501/000-006 Start module for 1-conductor female connector; 4 mm ² ; 1-pole; 4,00 mm ² ; blue	www.wago.com/769-501/000-006
	Item no.: 769-501/000-016 Start module for 1-conductor female connector; with integrated end plate; 4 mm ² ; 1-pole; 4,00 mm ² ; green-yellow	www.wago.com/769-501/000-016
	Item no.: 769-502 Center module for 1-conductor female connector; 4 mm ² ; 1-pole; 4,00 mm ² ; gray	www.wago.com/769-502
	Item no.: 769-502/000-006 Center module for 1-conductor female connector; 4 mm ² ; 1-pole; 4,00 mm ² ; blue	www.wago.com/769-502/000-006
	Item no.: 769-502/000-016 Center module for 1-conductor female connector; 4 mm ² ; 1-pole; 4,00 mm ² ; green-yellow	www.wago.com/769-502/000-016
	Item no.: 769-503 End module for 1-conductor female connector; 4 mm ² ; 1-pole; 4,00 mm ² ; gray	www.wago.com/769-503

Subject to changes. Please also observe the further product documentation!

	<p>Item no.: 769-503/000-006 End module for 1-conductor female connector; 4 mm²; 1-pole; 4,00 mm²; blue</p>	www.wago.com/769-503/000-006
	<p>Item no.: 769-503/000-016 End module for 1-conductor female connector; 4 mm²; 1-pole; 4,00 mm²; green-yellow</p>	www.wago.com/769-503/000-016
	<p>Item no.: 769-504 Start module for 2-conductor female connector; with integrated end plate; 4 mm²; 1-pole; 4,00 mm²; gray</p>	www.wago.com/769-504
	<p>Item no.: 769-504/000-006 Start module for 2-conductor female connector; with integrated end plate; 4 mm²; 1-pole; 4,00 mm²; blue</p>	www.wago.com/769-504/000-006
	<p>Item no.: 769-504/000-016 Start module for 2-conductor female connector; 4 mm²; 1-pole; 4,00 mm²; green-yellow</p>	www.wago.com/769-504/000-016
	<p>Item no.: 769-505 Center module for 2-conductor female connector; 4 mm²; 1-pole; 4,00 mm²; gray</p>	www.wago.com/769-505
	<p>Item no.: 769-505/000-006 Center module for 2-conductor female connector; 4 mm²; 1-pole; 4,00 mm²; blue</p>	www.wago.com/769-505/000-006
	<p>Item no.: 769-505/000-016 Center module for 2-conductor female connector; 4 mm²; 1-pole; 4,00 mm²; green-yellow</p>	www.wago.com/769-505/000-016
	<p>Item no.: 769-506 End module for 2-conductor female connector; 4 mm²; 1-pole; 4,00 mm²; gray</p>	www.wago.com/769-506
	<p>Item no.: 769-506/000-006 End module for 2-conductor female connector; 4 mm²; 1-pole; 4,00 mm²; blue</p>	www.wago.com/769-506/000-006
	<p>Item no.: 769-506/000-016 End module for 2-conductor female connector; 4 mm²; 1-pole; 4,00 mm²; green-yellow</p>	www.wago.com/769-506/000-016
	<p>Item no.: 769-512 Start module for 1-conductor female connector; angled; 4 mm²; 1-pole; 4,00 mm²; gray</p>	www.wago.com/769-512
	<p>Item no.: 769-512/000-006 Start module for 1-conductor female connector; angled; 4 mm²; 1-pole; 4,00 mm²; blue</p>	www.wago.com/769-512/000-006
	<p>Item no.: 769-512/000-016 Start module for 1-conductor female connector; angled; 4 mm²; 1-pole; 4,00 mm²; green-yellow</p>	www.wago.com/769-512/000-016

Subject to changes. Please also observe the further product documentation!



Item no.: 769-513
Center module for 1-conductor female connector; angled; 4 mm²; 1-pole; 4,00 mm²; gray

www.wago.com/769-513



Item no.: 769-513/000-006
Center module for 1-conductor female connector; angled; 4 mm²; 1-pole; 4,00 mm²; blue

www.wago.com/769-513/000-006



Item no.: 769-513/000-016
Center module for 1-conductor female connector; angled; 4 mm²; 1-pole; 4,00 mm²; green-yellow

www.wago.com/769-513/000-016



Item no.: 769-515
End module for 1-conductor female connector; angled; 4 mm²; 1-pole; 4,00 mm²; gray

www.wago.com/769-515



Item no.: 769-515/000-006
End module for 1-conductor female connector; angled; 4 mm²; 1-pole; 4,00 mm²; blue

www.wago.com/769-515/000-006



Item no.: 769-515/000-016
End module for 1-conductor female connector; angled; 4 mm²; 1-pole; 4,00 mm²; green-yellow

www.wago.com/769-515/000-016

Push-In type wire jumper



Item no.: 249-123
Push-in type wire jumper; 0.75 mm²; insulated; 180 mm long; black

www.wago.com/249-123



Item no.: 249-125
Push-in type wire jumper; insulated; 60 mm long; black

www.wago.com/249-125



Item no.: 249-126
Push-in type wire jumper; 0.75 mm²; insulated; 110 mm long; black

www.wago.com/249-126



Item no.: 249-127
Push-in type wire jumper; 0.75 mm²; insulated; 250 mm long; black

www.wago.com/249-127

Marking accessories



Item no.: 2009-145
Mini-WSB Inline; for Smart Printer; 1700 pieces on roll; stretchable 5 - 5.2 mm; plain; snap-on type; white

www.wago.com/2009-145



Item no.: 2009-145/000-002
Mini-WSB Inline; for Smart Printer; 1700 pieces on roll; stretchable 5 - 5.2 mm; plain; snap-on type; yellow

www.wago.com/2009-145/000-002



Item no.: 2009-145/000-005
Mini-WSB Inline; for Smart Printer; 1700 pieces on roll; stretchable 5 - 5.2 mm; plain; snap-on type; red

www.wago.com/2009-145/000-005



Item no.: 2009-145/000-006
Mini-WSB Inline; for Smart Printer; 1700 pieces on roll; stretchable 5 - 5.2 mm; plain; snap-on type; blue













www.wago.com/2009-145/000-006



Item no.: 2009-145/000-007
Mini-WSB Inline; for Smart Printer; 1700 pieces on roll; stretchable 5 - 5.2 mm; plain; snap-on type; gray

www.wago.com/2009-145/000-007

Subject to changes. Please also observe the further product documentation!

	Item no.: 2009-145/000-012 Mini-WSB Inline; for Smart Printer; 1700 pieces on roll; stretchable 5 - 5.2 mm; plain; snap-on type; orange	www.wago.com/2009-145/000-012
	Item no.: 2009-145/000-023 Mini-WSB Inline; for Smart Printer; 1700 pieces on roll; stretchable 5 - 5.2 mm; plain; snap-on type; green	www.wago.com/2009-145/000-023
	Item no.: 2009-145/000-024 Mini-WSB Inline; for Smart Printer; 1700 pieces on roll; stretchable 5 - 5.2 mm; plain; snap-on type; violet	www.wago.com/2009-145/000-024
	Item no.: 248-501 Miniature WSB Quick marking system; plain; Marker width 5 mm; 10 strips with 10 markers per card	www.wago.com/248-501
	Item no.: 248-501/000-002 Mini-WSB marking card; as card; not stretchable; plain; snap-on type; yellow	www.wago.com/248-501/000-002
	Item no.: 248-501/000-005 Mini-WSB marking card; as card; not stretchable; plain; snap-on type; red	www.wago.com/248-501/000-005
	Item no.: 248-501/000-006 Mini-WSB marking card; as card; not stretchable; plain; snap-on type; blue	www.wago.com/248-501/000-006
	Item no.: 248-501/000-007 Mini-WSB marking card; as card; not stretchable; plain; snap-on type; gray	www.wago.com/248-501/000-007
	Item no.: 248-501/000-012 Mini-WSB marking card; as card; not stretchable; plain; snap-on type; orange	www.wago.com/248-501/000-012
	Item no.: 248-501/000-017 Mini-WSB marking card; as card; not stretchable; plain; snap-on type; light green	www.wago.com/248-501/000-017
	Item no.: 248-501/000-023 Mini-WSB marking card; as card; not stretchable; plain; snap-on type; green	www.wago.com/248-501/000-023
	Item no.: 248-501/000-024 Mini-WSB marking card; as card; not stretchable; plain; snap-on type; violet	www.wago.com/248-501/000-024
protection		
	Item no.: 769-438 Pin cover; with marker slot for miniature WSB; gray	www.wago.com/769-438

Item no.: 769-439

Subject to changes. Please also observe the further product documentation!



Pin cover; with marker slot for miniature WSB; orange

www.wago.com/769-439

Coding



Item no.: 769-435

Coding pin; for coding of female plugs; for carrier terminal blocks / male connectors; orange

www.wago.com/769-435

assembling



Item no.: 209-106

Mounting carrier; for isolated mounting on DIN 35 rails; gray

www.wago.com/209-106



Item no.: 249-116

Screwless end stop; 6 mm wide; for DIN-rail 35 x 15 and 35 x 7.5; gray

www.wago.com/249-116

Carrier rail



Item no.: 210-112

Steel carrier rail; 35 x 7.5 mm; 1 mm thick; 2 m long; slotted; according to EN 60715; "Hole width 25 mm; silver-colored www.wago.com/210-112



Item no.: 210-113

Steel carrier rail; 35 x 7.5 mm; 1 mm thick; 2 m long; unslotted; according to EN 60715; silver-colored

www.wago.com/210-113



Item no.: 210-114

Steel carrier rail; 35 x 15 mm; 1.5 mm thick; 2 m long; unslotted; similar to EN 60715; silver-colored

www.wago.com/210-114



Item no.: 210-115

Steel carrier rail; 35 x 7.5 mm; 1 mm thick; 2 m long; slotted; according to EN 60715; "Hole width 18 mm; silver-colored www.wago.com/210-115



Item no.: 210-118

Steel carrier rail; 35 x 15 mm; 2.3 mm thick; 2 m long; unslotted; according to EN 60715; silver-colored

www.wago.com/210-118



Item no.: 210-196

Aluminum carrier rail; 35 x 8.2 mm; 1.6 mm thick; 2 m long; unslotted; similar to EN 60715; silver-colored

www.wago.com/210-196



Item no.: 210-197

Steel carrier rail; 35 x 15 mm; 1.5 mm thick; 2 m long; slotted; similar to EN 60715; silver-colored

www.wago.com/210-197



Item no.: 210-198

Copper carrier rail; 35 x 15 mm; 2.3 mm thick; 2 m long; unslotted; according to EN 60715; copper-colored

www.wago.com/210-198



Item no.: 210-504

Steel carrier rail; 35 x 7.5 mm; 1 mm thick; 2 m long; slotted; galvanized; according to EN 60715; silver-colored

www.wago.com/210-504



Item no.: 210-505

Steel carrier rail; 35 x 7.5 mm; 1 mm thick; 2 m long; unslotted; galvanized; according to EN 60715; silver-colored

www.wago.com/210-505



Item no.: 210-506

Steel carrier rail; 35 x 15 mm; 1.5 mm thick; 2 m long; unslotted; galvanized; similar to EN 60715; silver-colored

www.wago.com/210-506



Item no.: 210-508

Steel carrier rail; 35 x 15 mm; 1.5 mm thick; 2 m long; slotted; galvanized; similar to EN 60715; silver-colored

www.wago.com/210-508

Subject to changes. Please also observe the further product documentation!

WAGO Kontakttechnik GmbH & Co. KG

Hansastr. 27

32423 Minden

Phone: +49571 887-0 | Fax: +49571 887-169

Email: info.de@wago.com | Web: www.wago.com

Do you have any questions about our products?

We are always happy to take your call at +49 (571) 887-44222.

End plate

	Item no.: 769-313 Separator plate; 1.1 mm thick; oversized; orange	www.wago.com/769-313
--	---	--

tools

	Item no.: 210-720 Operating tool; Blade: 3.5 x 0.5 mm; with a partially insulated shaft; multicoloured	www.wago.com/210-720
--	---	--

Downloads

Documentation

Bid Text

769-209/281-434 X81 - Datei	19. 2. 2019	xml 3.0 kB	Download
769-209/281-434 doc - Datei	2. 10. 2017	doc 24.6 kB	Download

Additional Information

Technical explanations	3. 4. 2019	pdf 2.2 MB	Download
------------------------	------------	---------------	----------

CAD/CAE-Data

CAD data

2D/3D Models 769-209/281-434	URL	Download
------------------------------	-----	----------

CAE data

EPLAN Data Portal 769-209/281-434	URL	Download
WSCAD Universe 769-209/281-434	URL	Download
ZUKEN Portal 769-209/281-434	URL	Download
WSCAD Universe 769-209/281-434	URL	Download
EPLAN Data Portal 769-209/281-434	URL	Download

Subject to changes. Please also observe the further product documentation!

Environmental Product Compliance

Compliance Search

Environmental Product Compliance 769-209/281-434

URL

Download

2-pin component carrier block; with 2 jumper positions; LED (red); 24 VDC; for DIN-rail
35 x 15 and 35 x 7.5; gray

Installation Notes

Installation

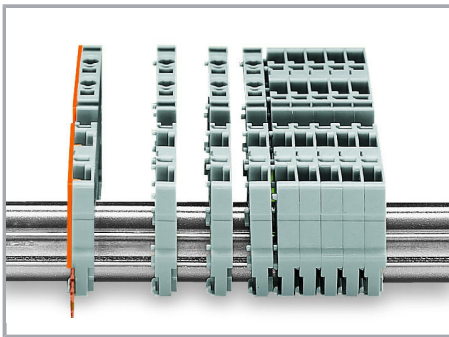

Snap individual carrier terminal blocks onto the DIN-rail and slide together.

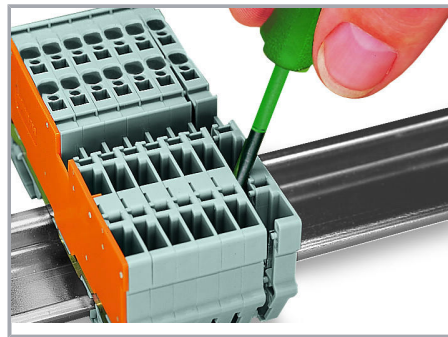

Open the assembly by laterally sliding a block via operating tool and remove terminal block via release lever.

Commoning

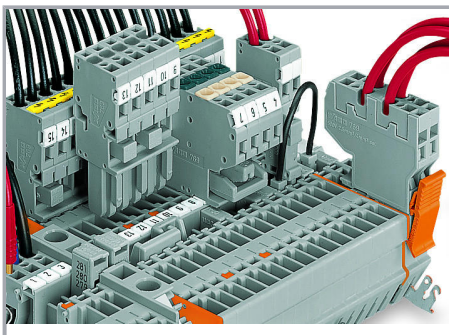

Commoning with adjacent or staggered jumpers.

Push jumpers down until fully inserted.

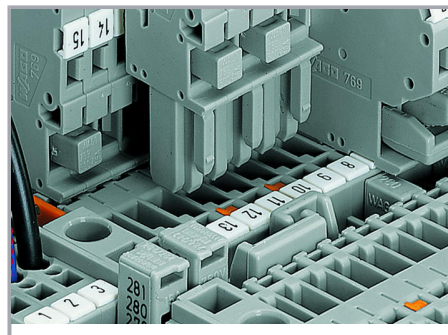

Commoning carrier terminal blocks via staggered jumpers.

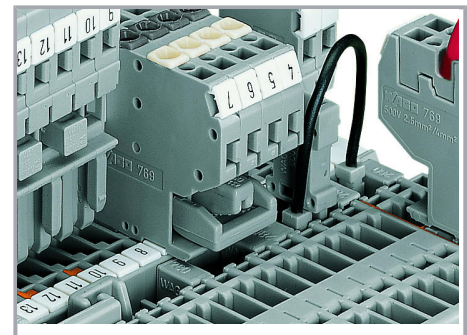

Commoning a 2-conductor female plug via staggered jumper and carrier terminal blocks via adjacent jumpers.

Subject to changes. Please also observe the further product documentation!

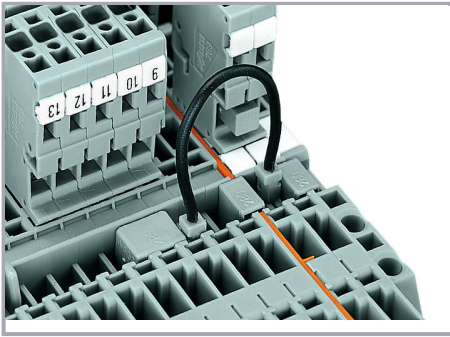

Commoning carrier terminal blocks via push-in type wire jumpers or adjacent jumpers – even over an intermediate plate.

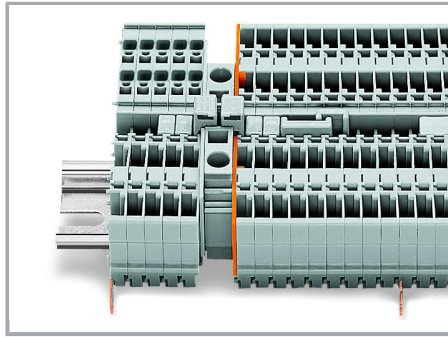

Commoning “supply terminal blocks” (up to 10 mm²/8 AWG) with carrier terminal blocks via step-down jumpers.

Testing

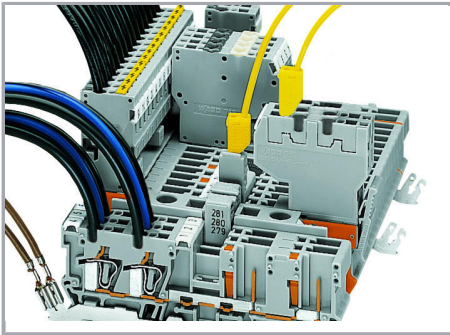

Testing with a 2.3 mm Ø test plug (max. 42 V).

Coding

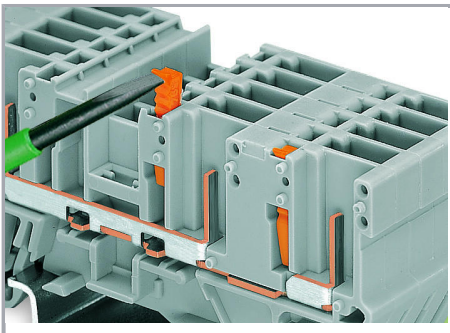

Snap coding pin in proper direction on carrier terminal block.

Shown: Coding pin removal from carrier terminal block.

Locking system

Subject to changes. Please also observe the further product documentation!

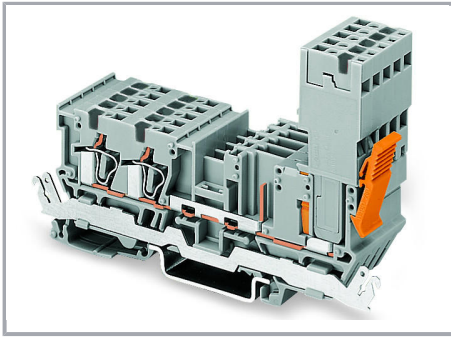

Securing a female plug via locking lever on the terminal block side.

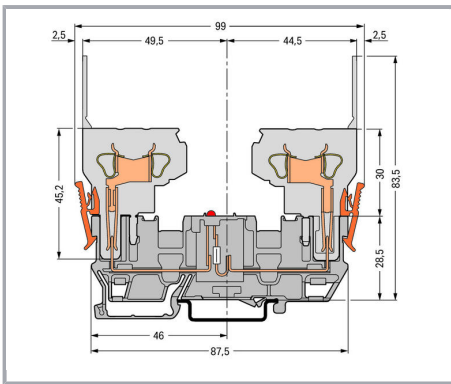

LED carrier terminal block

For other dimensions, see carrier terminal block (769-151).

Subject to changes. Please also observe the further product documentation!

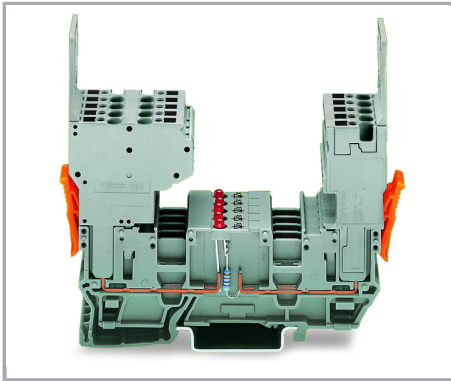

2-conductor and 1-conductor female plugs
(may be reversed)

LED carrier terminal blocks can be
commoned via 280 and 780 Series Jumpers
and tested using a test plug adapter (280-4..).

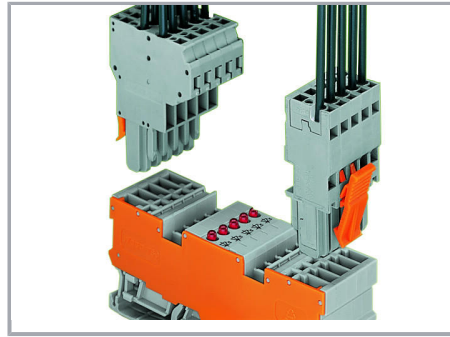

2-pin LED carrier terminal block with 2
jumper positions

2-conductor female connector

1-conductor female plug, straight

Product family

X-COM

[Show all products from the family](#)

Subject to changes. Please also observe the further product documentation!