

1. Brief

RFDK_PIC16_LCD_Ver1.1 It's the newest version DK from Hoperf which is for COB RF module development and test. It's an easy way to make customer know the performance of the RF module by simple demonstration. Customer can find the file RFDK_PIC16_LCD_Ver1.1 and download the demo code accordingly which is for any of the COB module from the website www.hoperf.com .it's very simple to use the DK, Customer can change the parameters easily ,it's easy to do TX and RX test. It can help customer to short the time from prototype to final production.

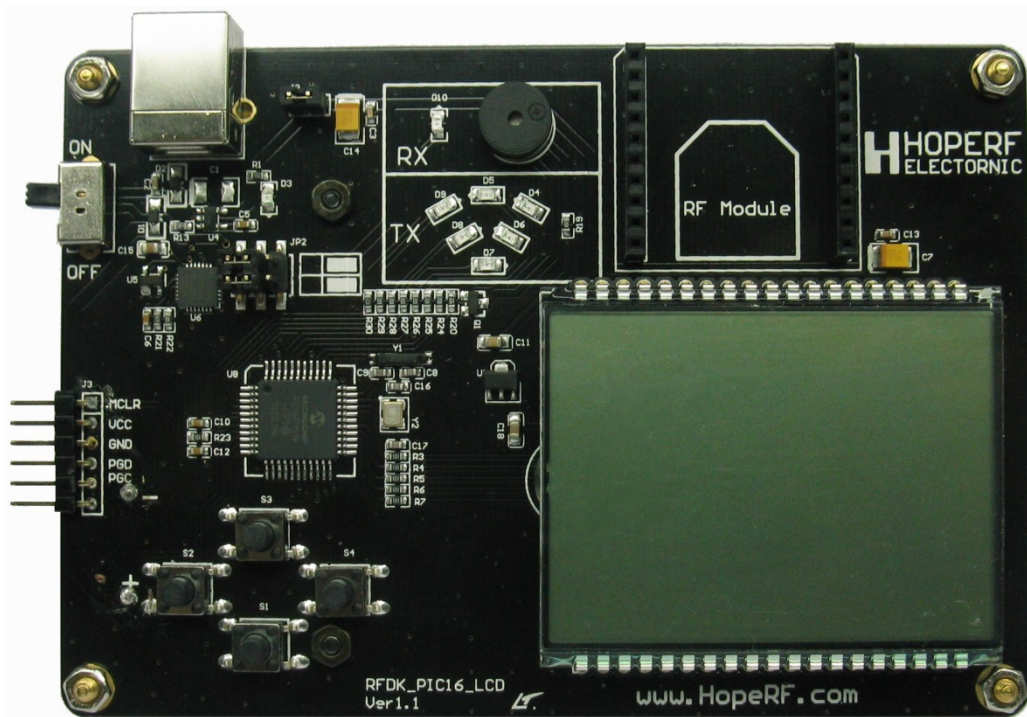

Figure 1 RFDK_PIC16_LCD_Ver1.1

2. Development conditions

- Power supply:
 - battery: 4 x 1.5V (AA) ;
 - USB: 5V ;
- RFDK_PIC16_LCD_Ver1.1 MCU:
 - MICROCHIP: PIC16F1519
- RFDK_RFMxx_DEMO_V2.1 soft IDE:
 - MPLAB IDE V8.88 or over V8.88
- Support the modules:
 - RFM01/02/12B;
 - RFM22B/23B/31B/42B/43B;
 - RFM24/26;
 - RFM63/64/65/66/67/68/69/69H;
 - RFM92/93/95/96/97/98 (LoRa);

3. Hardware and user interface

- RFDK_PIC16_LCD_Ver1.1 Front view:

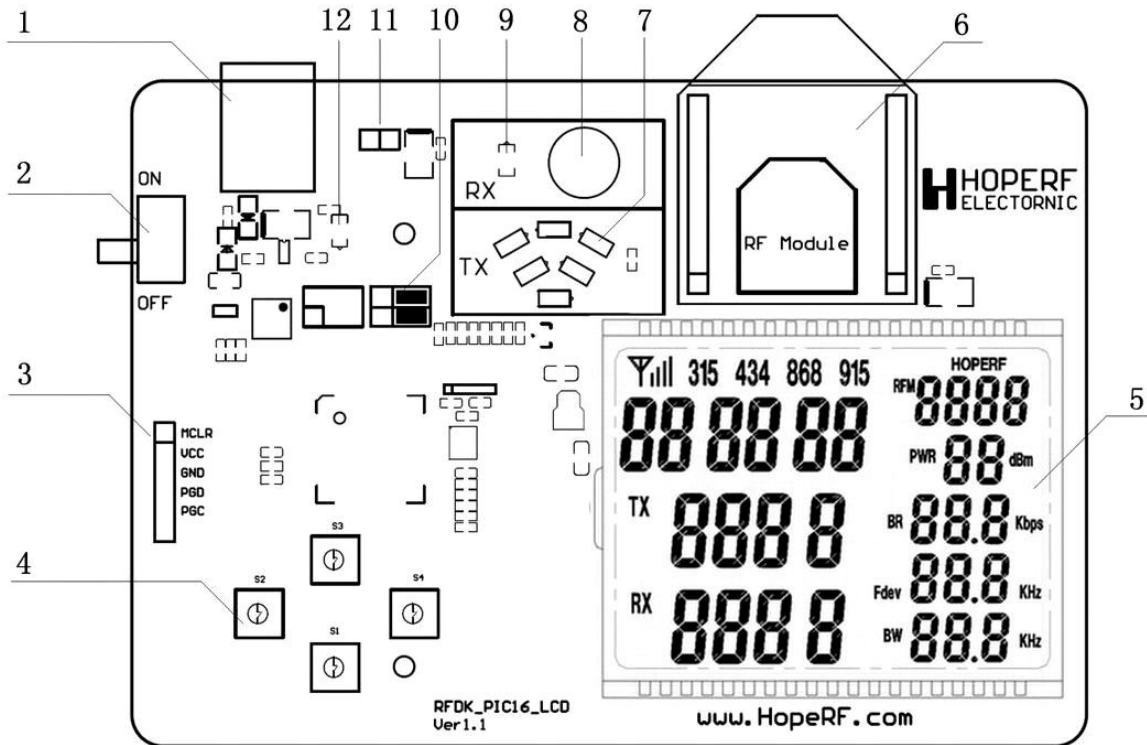

No.	Function
1	USB socket (power supply or UART data communication)
2	Power switch
3	MCU Debug interface
4	Key board (S1: Set Key\ S3: Enter Key\ S2: Left Key\ S4: Right Key)
5	LCD display
6	COB module socket
7	TX Status LED
8	Buzzer
9	RX Status LED
10	Series connecting port Jumper (Jumper right side enable uart)
11	Current test jumper(Connecting is the default status)
12	Power status LED

- COB Module interface specification:

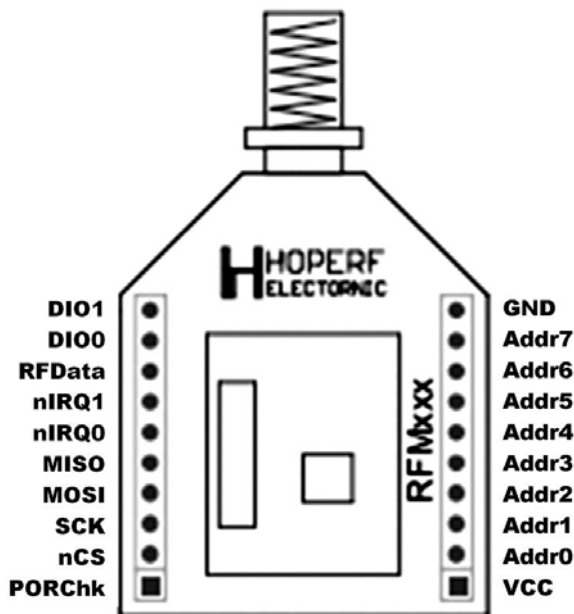
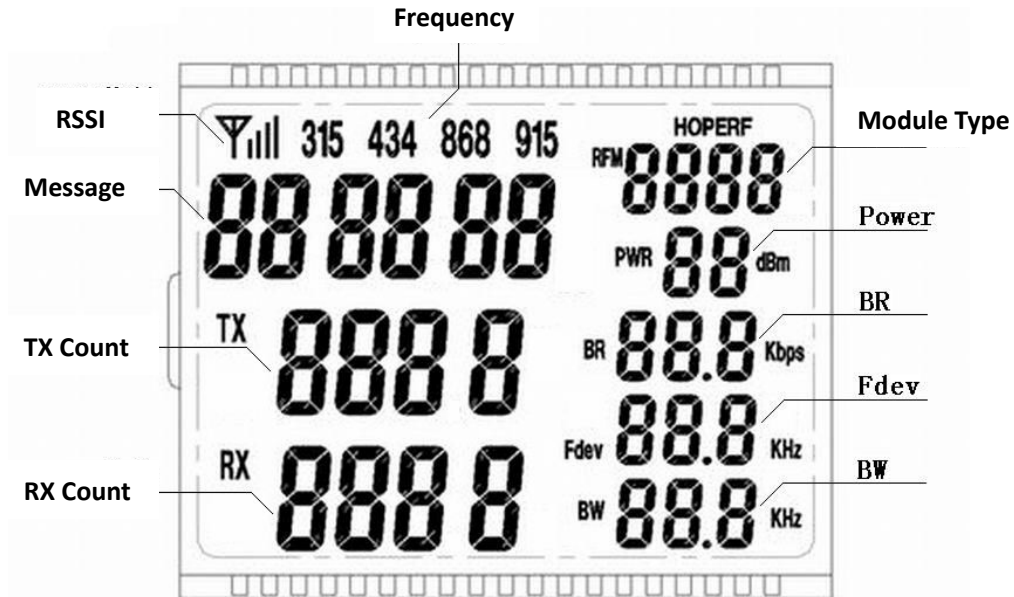

Figure 2 RF_COB Module conversion interface

RF_COB Module conversion interface	Function description
PORChk	Reset (I/O)
nCS	SPI SEL (I/O)
SCK	SPL Clock (I/O)
MOSI	SPI MOSI (I/O)
MISO	SPI MISO (I/O)
nIRQ0	IRQ interrupt0 (I/O)
nIRQ1	Please refer to the specific module
RFDData	RF data output (I/O)
DIO0	Please refer to the specific module
DIO1	Please refer to the specific module
GND	GND
Addr7~Addr0	Module Identification address
VCC	VCC

- LCD Display specification
LCD display overview:



4. Operation specification (example: LoRa COB module ofRFM92)

1、 Getting the demo code

- Download the demo code RFDK_RFM92_V2.1 from <http://www.hoperf.com>;
- Open and compile the project by MPLAB IDE, Download to RFDK_PIC16_LCD_Ver1.1.
- Plug the RFM92 COB module to the socket.
- Board RFDK_PIC16_LCD_Ver1.1 can support multiple types of COB module, also its take customer's choice. COB Module DEMO program selection method is as follows: First press on the "set key", then turn the power switch on. After it, the power light on with starting music, at this time the LCD screen will display all the segment code. When the music is over, the LCD will display as the following figure, the module type display area is flashing, you can through the "left key" or "right key" to select the type of COB module. After selection, you can press on "enter key" to exit the module selection mode.



2、 Choice modulation mode

- The DEMO currently supports two modulation mode selection: FSK and LoRa;
- Press the Set Key and into the modulation selection.
- In the setting mode, the information display area flashes. Select the modulation mode by Left Key or Right Key, after selection Press Enter Key out of the setting mode. There is a example show as below figure.

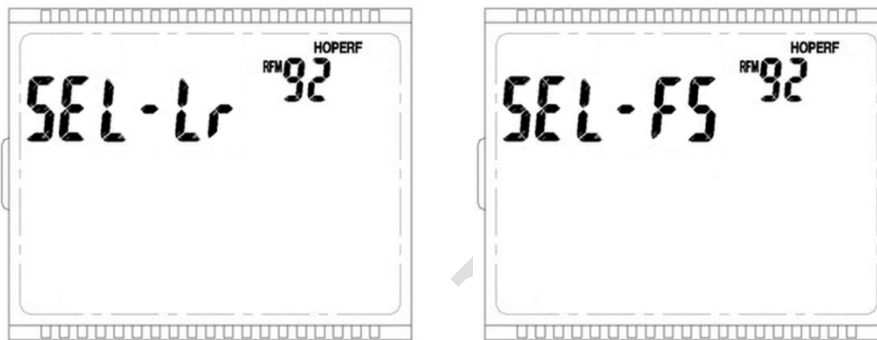

- If the module is without LoRa modulation mode then it will be turn to the default mode directly.

3、 Operation specification of FSK mode

- After choice the required module and FSK mode, System entry work mode(Setting mode), it can be select the work mode by press the “Left Key”or “Right Key”. Here is some presentations which show as below:

- 1、 **Setting Mode:** Pressing the “Enter Key” at the first screen it’s the RF setting module, you can see the “SET” at top left corner, press the “SET” then the parameter start flash on the LCD, Press “Left Key” and “Right Key” setting different parameters with specifical value then Press “Enter Key” confirm the setting, there will be a beep by buzzer after that. You can take the figure as reference below.

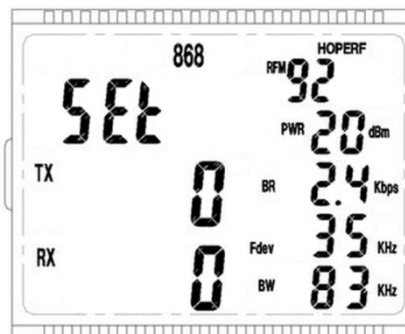

- 2、 **Transmitting mode:** On this mode, press the “Enter Key” when the “FS--t” is flash on the LCD. It enter Normal transmitting mode, there will be a beep by buzzer after that and the TX and RX count turn to be Zero. After all of this ready, it starts transmitting and the TX Status LED start flash sequentially. The module will transmit a message in every 0.5s, TX will show the counting number of the message. If the module not works then the LCD will show “Err” and the buzzer will trigger a warning tone. It’s showed as below for two kind of situation.

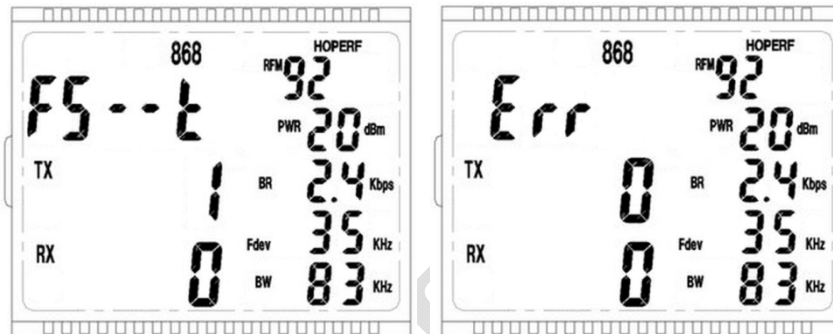

Normal sending message

Module error

- 3、 **Normal receiving mode:** On this mode, press the “Enter Key” when the “FS--r” is flash on the LCD. It enter Normal receiving mode, there will be a beep by buzzer after that and the TX and RX count turn to be Zero. After all of this ready, it starts receiving mode and the RX Status LED turns on. RX will show the counting number of the message according receiving message number and the buzzer will trigger a warning tone and also it shows the “RSSI value” on the LCD. If the module not works then the LCD will show “Err” and the buzzer will trigger a warning tone. It shows the normal receiving mode as below figure.



Normal receiving mode

- 4、 **Transmitting test mode:** On this mode, press the “Enter Key” when the “t--t” is flash on the LCD. It enter transmitting test mode, there will be a beep by buzzer after that and the TX and RX count turn to be Zero. After all of this ready, it starts transmitting and the TX Status LED start flash sequentially. The module will transmit carrier signal. It’s easy way to test center frequency and power output. If the module not works then the LCD will show “Err” and the buzzer will trigger a warning tone. It shows the

transmitting test mode as below figure.

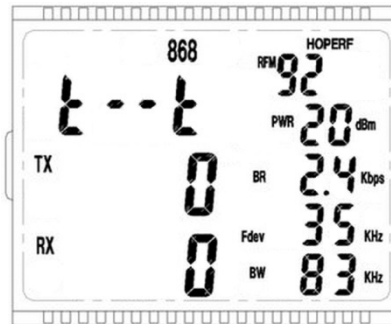

Transmitting test mode

5、 **Receiving test mode:** On this mode, press the “Enter Key” when the “t-r” is flash on the LCD. It enter Normal receiving mode, there will be a beep by buzzer after that and the TX and RX count turn to be Zero. After all of this ready, it starts receiving test mode and the RX Status LED turns on and also it shows the “RSSI value” on the LCD. Connecting the RF module to a signal generator and then detect the “RF Data” pin with an oscilloscope and test the sensitivity by tuning the signal strength of the signal Generator. If the module not works then the LCD will show “Err” and the buzzer will trigger a warning tone. It shows the normal receiving mode as below figure.

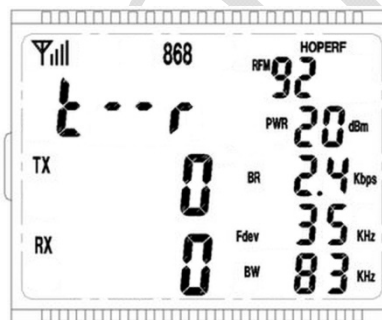

Receiving test mode

6、 **Sleeping mode:** On this mode, press the “Enter Key” when the “SLEEP” is flash on the LCD. It enter sleeping mode, there will be a beep by buzzer after that and the TX and RX count turn to be Zero. After all of this ready, it starts the sleeping mode. it can measure the sleeping current. It shows the sleeping mode as below figure.

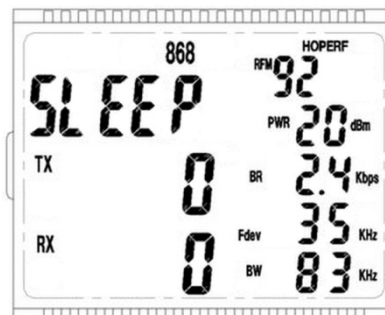

Sleeping mode

- The system automatically save the configuration parameters, re-power, will automatically enter the previous working mode.

4、 Operation specification of LoRa mode

- After choice the required module and LoRa mode, System entry work mode(Setting mode), it can be select the work mode by press the “Left Key” or “Right Key”. Here is some presentations which show as below:

- 1、 **Setting Mode:** Pressing the “Enter Key” at the first screen it’s the RF setting mode, you can see the “SET” at top left corner, double press the “SET Key” then the parameter start flash on the LCD, Press “Left Key” and “Right Key” setting different parameters with specific value then Press “Enter Key” confirm the setting, there will be a warning tone sounded by buzzer after that. You can take the figure as reference below.

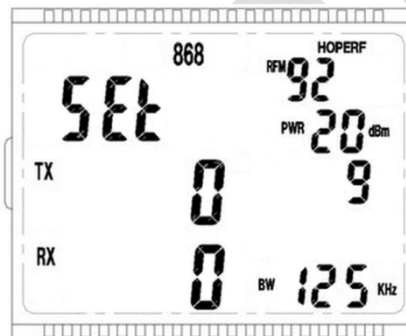

- 2、 **Normal transmitting mode:** On this mode, press the “Enter Key” when the “Lr--t” is flash on the LCD. It enter Normal transmitting mode, there will be a beep by buzzer after that and the TX and RX count turn to be Zero. After all of this ready, it starts transmitting and the TX Status LED start flash sequentially. The module will transmit a message in every 0.5s, TX will show the counting number of the message. If the module not works then the LCD will show “Err” and the buzzer will trigger a warning tone. It’s showed as below for two kind of situation.

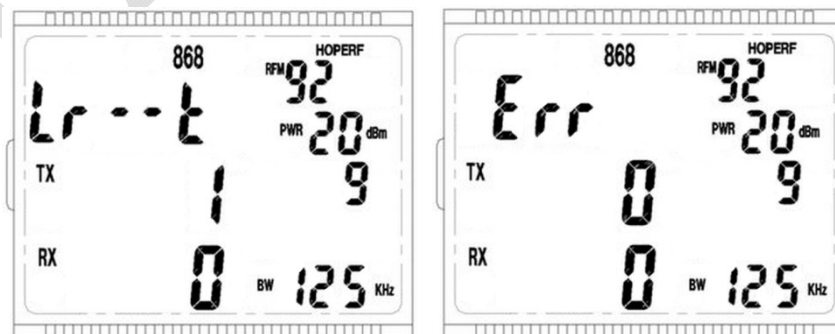

- 3、 **Normal receiving mode:** On this mode, press the “Enter Key” when the “Lr--r” is flash on the LCD. It enter Normal receiving mode, there will be a beep by buzzer after that and the TX and RX count turn to be Zero. After all of this ready, it starts

receiving mode and the RX Status LED turns on. RX will show the counting number of the message according receiving message number and the buzzer will trigger a warning tone and also it shows the “RSSI value” on the LCD. If the module not works then the LCD will show “Err” and the buzzer will trigger a warning tone. It shows the normal receiving mode as below figure.



- 4、 **Transmitting test mode:** On this mode, press the “Enter Key” when the “t--t” is flash on the LCD. It enter transmitting test mode, there will be a beep by buzzer after that and the TX and RX count turn to be Zero. After all of this ready, it starts transmitting and the TX Status LED start flash sequentially. The module will transmit carrier signal. It’s easy way to test center frequency and power output. If the module not works then the LCD will show “Err” and the buzzer will trigger a warning tone. It shows the transmitting test mode as below figure.

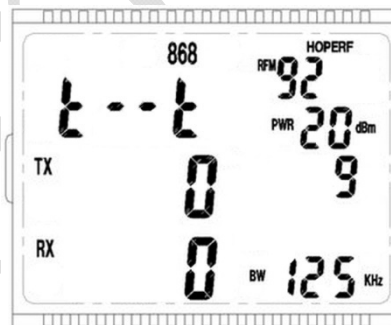

- 5、 **Receiving test mode:** On this mode, press the “Enter Key” when the “t--r” is flash on the LCD, It enter Normal receiving mode, there will be a beep by buzzer after that and the TX and RX count turn to be Zero. After all of this ready, it starts receiving test mode and the RX Status LED turns on and also it shows the “RSSI value” on the LCD. Connecting the RF module to a signal generator and then detect the “RFData” pin with an oscilloscope and test the sensitivity by tuning the signal strength of the signal Generator. If the module not works then the LCD will show “Err” and the buzzer will trigger a warning tone. It shows the normal receiving mode as below figure.

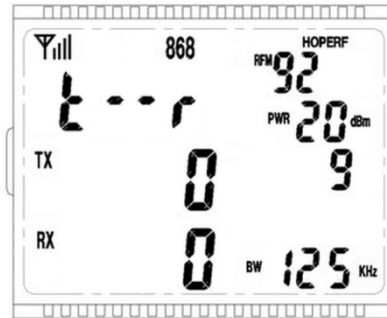

- 6、 **Sleeping mode:** On this mode, press the “Enter Key” when the “SLEEP” is flash on the LCD. It enter sleep mode, there will be a beep by buzzer after that and the TX and RX count turn to be Zero. After all of this ready, it starts sleeping mode, it can measure the sleep current. It shows the sleeping mode as below figure.



- The system automatically save the configuration parameters, re-power, will automatically enter the previous working mode.

5、 Modulation method and parameter list

- If you need this development board communicate with other RF module, the modulation, parameters, and sending and receiving data packet format should be the same.

1、RFDK_RFMxx_V2.0 commonly used parameters : (**RFDK** Expressed in boldface platform default parameters)

COB Module (modulation)	Center frequency	output Power	Rate/spread ing factor	frequency deviation	bandwidth	Form
RFM92 (FSK)	868MHz 915MHz	20dbm 17dbm 14dbm 11dbm	1.2Kbps 2.4Kbps 4.8Kbps 9.6bps	35KHz	83KHz	TX/RX
RFM92 (LoRa)	868MHz 915MHz	20dbm 17dbm 14dbm 11dbm	6、7、8、9、 10、11、12		125 K 、250 K、500 K、	TX/RX
RFM93 (FSK)	868MHz 915MHz	20dbm 17dbm 14dbm 11dbm	1.2Kbps 2.4Kbps 4.8Kbps 9.6bps	35KHz	83KHz	TX/RX
RFM93 (LoRa)	868MHz 915MHz	20dbm 17dbm 14dbm 11dbm	6、7、8、9		125 K 、250 K、500 K、	TX/RX
RFM95 (FSK)	868MHz 915MHz	20dbm 17dbm 14dbm 11dbm	1.2Kbps 2.4Kbps 4.8Kbps 9.6bps	35KHz	83KHz	TX/RX
RFM95 (LoRa)	868MHz 915MHz	20dbm 17dbm 14dbm 11dbm	6、7、8、9、 10、11、12		7.8K、10.4 K、15.6 K、 20.8 K、31.2 K、41.7 K、 62.5 K、 125 K 、250 K、 500 K、	TX/RX
RFM96 (FSK)	434MHz	20dbm 17dbm 14dbm 11dbm	1.2Kbps 2.4Kbps 4.8Kbps 9.6bps	35KHz	83KHz	TX/RX
RFM96 (LoRa)	434MHz	20dbm 17dbm 14dbm 11dbm	6、7、8、9、 10、11、12		7.8K、10.4 K、15.6 K、 20.8 K、31.2 K、41.7 K、 62.5 K、 125 K 、250 K、 500 K、	TX/RX

RFM97 (FSK)	868MHz 915MHz	20dbm 17dbm 14dbm 11dbm	1.2Kbps 2.4Kbps 4.8Kbps 9.6bps	35KHz	83KHz	TX/RX
RFM97 (LoRa)	868MHz 915MHz	20dbm 17dbm 14dbm 11dbm	6、7、8、9		7.8K、10.4 K、15.6 K、 20.8 K、31.2 K、41.7 K、 62.5 K、 125 K、250 K、 500 K、	TX/RX
RFM98 (FSK)	434MHz	20dbm 17dbm 14dbm 11dbm	1.2Kbps 2.4Kbps 4.8Kbps 9.6bps	35KHz	83KHz	TX/RX
RFM98 (LoRa)	434MHz	20dbm 17dbm 14dbm 11dbm	6、7、8、9、 10、11、12		7.8K、10.4 K、15.6 K、 20.8 K、31.2 K、41.7 K、 62.5 K、 125 K、250 K、 500 K、	TX/RX
RFM69H (FSK)	315MHz 434MHz 868MHz 915MHz	20dbm 17dbm 14dbm 11dbm	1.2Kbps 2.4Kbps 4.8Kbps 9.6bps	35KHz	83KHz	TX/RX
RFM69 (FSK)	315MHz 434MHz 868MHz 915MHz	13dbm 10dbm 7dbm 4dbm	1.2Kbps 2.4Kbps 4.8Kbps 9.6bps	35KHz	83KHz	TX/RX
RFM68 (FSK)	434MHz 868MHz 915MHz	10dbm	2.4Kbps	35KHz		TX
RFM67 (FSK)	315MHz 434MHz 868MHz 915MHz	17dbm 14dbm 11dbm 8dbm	1.2Kbps 2.4Kbps 4.8Kbps 9.6bps	35KHz		TX
RFM66 (FSK)	315MHz 434MHz 868MHz 915MHz	20dbm 17dbm 14dbm 11dbm	1.2Kbps 2.4Kbps 4.8Kbps 9.6bps	35KHz	83KHz	TX/RX
RFM65	315MHz		1.2Kbps		83KHz	RX

(FSK)	434MHz 868MHz 915MHz		2.4Kbps 4.8Kbps 9.6bps			
RFM64 (FSK)	315MHz 434MHz	13dbm 10dbm 7dbm 4dbm	1.2Kbps 2.4Kbps 4.8Kbps 9.6bps	35KHz	200KHz	TX/RX
RFM63 (FSK)	868MHz 915MHz	13dbm 10dbm 7dbm 4dbm	1.2Kbps 2.4Kbps 4.8Kbps 9.6bps	35KHz	200KHz	TX/RX
RFM24 (FSK)	315MHz 434MHz 868MHz 915MHz	13dbm 10dbm 7dbm 4dbm	2.4Kbps	35KHz	150KHz	TX/RX
RFM26 (FSK)	315MHz 434MHz 868MHz 915MHz	20dbm 17dbm 14dbm 11dbm	2.4Kbps	35KHz	150KHz	TX/RX
RFM22B (FSK)	315MHz 434MHz 868MHz 915MHz	20dbm 17dbm 14dbm 11dbm	1.2Kbps 2.4Kbps 4.8Kbps 9.6bps	35KHz	80KHz	TX/RX
RFM23B (FSK)	315MHz 434MHz 868MHz 915MHz	13dbm 10dbm 7dbm 4dbm	1.2Kbps 2.4Kbps 4.8Kbps 9.6bps	35KHz	80KHz	TX/RX
RFM42B (FSK)	315MHz 434MHz 868MHz 915MHz	20dbm 17dbm 14dbm 11dbm	1.2Kbps 2.4Kbps 4.8Kbps 9.6bps	35KHz		TX
RFM43B (FSK)	315MHz 434MHz 868MHz 915MHz	13dbm 10dbm 7dbm 4dbm	1.2Kbps 2.4Kbps 4.8Kbps 9.6bps	35KHz		TX
RFM31B (FSK)	315MHz 434MHz 868MHz 915MHz		1.2Kbps 2.4Kbps 4.8Kbps 9.6bps		80KHz	RX
RFM12B (FSK)	434MHz 868MHz 915MHz	8dbm 5dbm 2dbm	1.2Kbps 2.4Kbps 4.8Kbps	30KHz	134KHz	TX/RX

			9.6bps			
RFM02 (FSK)	434MHz 868MHz 915MHz	8dbm 5dbm 2dbm	1.2Kbps 2.4Kbps 4.8Kbps 9.6bps	30KHz		TX
RFM01 (FSK)	434MHz 868MHz 915MHz		1.2Kbps 2.4Kbps 4.8Kbps 9.6bps		134KHz	RX

2、 Sending and receiving data packet format:

COB module	Preamble + Sync Word (FSK)	Message content
RFM92	"AAAAAAAA2DD4"	"HopeRF RFM COBRFM92-S"
RFM93	"AAAAAAAA2DD4"	"HopeRF RFM COBRFM93-S"
RFM95	"AAAAAAAA2DD4"	"HopeRF RFM COBRFM95-S"
RFM96	"AAAAAAAA2DD4"	"HopeRF RFM COBRFM96-S"
RFM97	"AAAAAAAA2DD4"	"HopeRF RFM COBRFM97-S"
RFM98	"AAAAAAAA2DD4"	"HopeRF RFM COBRFM98-S"
RFM69H	"AAAAAAAA2DD4"	"HopeRF RFM COBRFM69HS"
RFM69	"AAAAAAAA2DD4"	"HopeRF RFM COBRFM69-S"
RFM68	"AAAAAAAA2DD4"	"HopeRF RFM COBRFM68-S"
RFM67	"AAAAAAAA2DD4"	"HopeRF RFM COBRFM67-S"
RFM66	"AAAAAAAA2DD4"	"HopeRF RFM COBRFM66-S"
RFM65	"AAAAAAAA2DD4"	"HopeRF RFM COBRFM65-S"
RFM64	"AAAAAAAA2DD4"	"HopeRF RFM COBRFM64-S"
RFM63	"AAAAAAAA2DD4"	"HopeRF RFM COBRFM63-S"
RFM24	"AAAAAAAA2DD4"	"HopeRF RFM COBRFM24-S"
RFM26	"AAAAAAAA2DD4"	"HopeRF RFM COBRFM26-S"
RFM22B	"AAAAAAAA2DD4"	"HopeRF RFM COBRFM22BS"
RFM23B	"AAAAAAAA2DD4"	"HopeRF RFM COBRFM23BS"
RFM42B	"AAAAAAAA2DD4"	"HopeRF RFM COBRFM42BS"
RFM43B	"AAAAAAAA2DD4"	"HopeRF RFM COBRFM43BS"
RFM31B	"AAAAAAAA2DD4"	"HopeRF RFM COBRFM31BS"
RFM12B	"AAAAAAAA2DD4"	"HopeRF RFM COBRFM12BS"
RFM02	"AAAAAAAA2DD4"	"HopeRF RFM COBRFM02-S"
RFM01	"AAAAAAAA2DD4"	"HopeRF RFM COBRFM01-S"

6. Related products

- HopeRF EVB board can use all sorts of COB module and communicate with RFDK_PIC16_LCD_Ver1. EVB board real figure shows below:

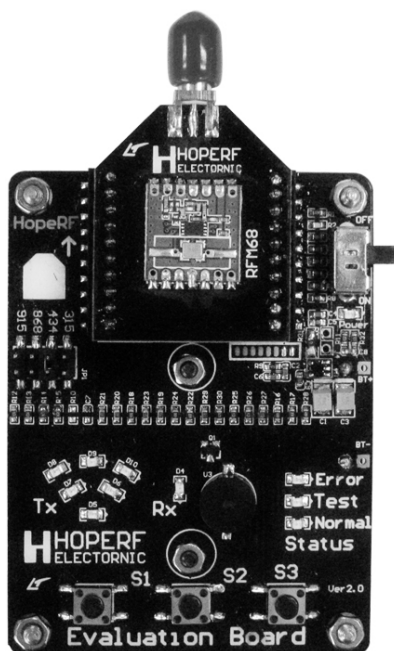

- For more information please visit the website www.hoperf.com

HOPE MICROELECTRONICS CO.,LTD
Add: 2/F, Building 3, Pingshan Private
Enterprise Science and Technology
Park, Lishan Road, XiLi Town, Nanshan
District, Shenzhen, Guangdong, China
Tel: 86-755-82973805
Fax: 86-755-82973550
Email: sales@hoperf.com
Website: <http://www.hoperf.com>
<http://www.hoperf.cn>

This document may contain preliminary information and is subject to change by Hope Microelectronics without notice. Hope Microelectronics assumes no responsibility or liability for any use of the information contained herein. Nothing in this document shall operate as an express or implied license or indemnity under the intellectual property rights of Hope Microelectronics or third parties. The products described in this document are not intended for use in implantation or other direct life support applications where malfunction may result in the direct physical harm or injury to persons. NO WARRANTIES OF ANY KIND, INCLUDING, BUT NOT LIMITED TO, THE IMPLIED WARRANTIES OF MECHANABILITY OR FITNESS FOR A PARTICULAR PURPOSE, ARE OFFERED IN THIS DOCUMENT.

©2006, HOPE MICROELECTRONICS CO.,LTD. All rights reserved.