

BMM350

Handling, Soldering and Mounting Instruction



BST-BMM350-HS000-04

Document revision	1.4
Document release date	June 2023
Document number	BST-BMM350-HS000-04
Sales part number	0273.017.027

Notes Data and descriptions in this document are subject to change without notice. Product photos and pictures are for illustration purposes only and may differ from the real product appearance.

Table of Contents

1 Purpose of this document	4
1.1 Who should read this manual?.....	4
2 Device Marking	4
3 PCB Design and Device Placing recommendations	4
3.1 Push-button contacts.....	4
3.2 Thermal hot spots on the PCB.....	5
3.3 Distance to PCB anchor points.....	5
3.4 Vibrations on the PCB.....	5
3.5 Redundant PCB anchor points.....	6
3.6 Mechanical stress maximum on the PCB.....	6
3.7 Resin coatings.....	7
3.1 RF electric field sources.....	7
4 PCB placement guideline based on magnetic influences	7
4.1 Non-geomagnetic field sources.....	7
4.1.1 On-board: Hard ferromagnetic materials.....	7
4.1.2 On-board: Current-induced fields.....	8
4.1.3 Comparison of geomagnetic field strength to other fields.....	8
4.2 Distortion and shielding by soft magnetic materials.....	8
4.2.1 On-board: Distortion.....	9
4.2.2 On-board and external: Shielding.....	9
4.2.3 Overview of external influences.....	10
4.3 Possibilities and limitations of software compensation.....	10
4.4 PCB placement advice.....	11
4.5 Hard magnetic offsets.....	11
4.5.1 PCB Currents.....	12
4.5.2 Soft magnetic effects.....	13
4.5.3 Overview.....	13
5 PCB layout recommendation	14
5.1 Dimensions and landing pattern recommendation.....	14
5.2 Connection diagram.....	15
5.3 Layout recommendations.....	15

6 Reflow Soldering & Moisture Sensitivity Level	16
7 Wafer Level Chip Scale Package Handling	16
8 Handling of reels	17
8.1 Storage	17
8.2 Introduction into production	17
8.3 Orientation of sensors on the reel	18
8.4 Reel Dimensions	19
9 Returning WLCSP for Failure Analysis	19
10 Environmental Safety	20
10.1 RoHS	20
10.2 Halogen content	20
11 Legal Disclaimer	21
11.1 Engineering samples	21
11.2 Product use	21
11.3 Application examples and hints	21
12 Document history and modification	22

1 Purpose of this document

This document describes the conditions and parameters to be applied when handling, soldering, and mounting the BMM350 to a PCB.

1.1 Who should read this manual?

This document is intended as a practical guidance for

- Hardware designer in terms of device handling, mounting, placement and environmental influences in the target system.
- Application engineers to deal with the disturbances caused due to the external magnetic fields.
- In addition, it will also explain which phenomena can and cannot be compensated for by software.

2 Device Marking

Please refer to the latest version of the corresponding product datasheet.

3 PCB Design and Device Placing recommendations

MEMS sensors are high-precision measurement devices which consist of electronic as well as mechanical silicon structures, designed for precision, efficiency, and mechanical robustness.

However, to achieve best possible results for your design, the following recommendations should be taken into consideration when mounting the sensor on a printed- circuit board (PCB).

It is generally recommended to keep a reasonable distance between the sensor mounting location on the PCB and the critical points described in the following examples. The exact value for a “reasonable distance” depends on many customer specific variables and must therefore be determined case by case on system level.

3.1 Push-button contacts

Keep a reasonable distance to push-button contacts, when placing the sensor device. Do not position the sensor directly beneath a push-button contact.

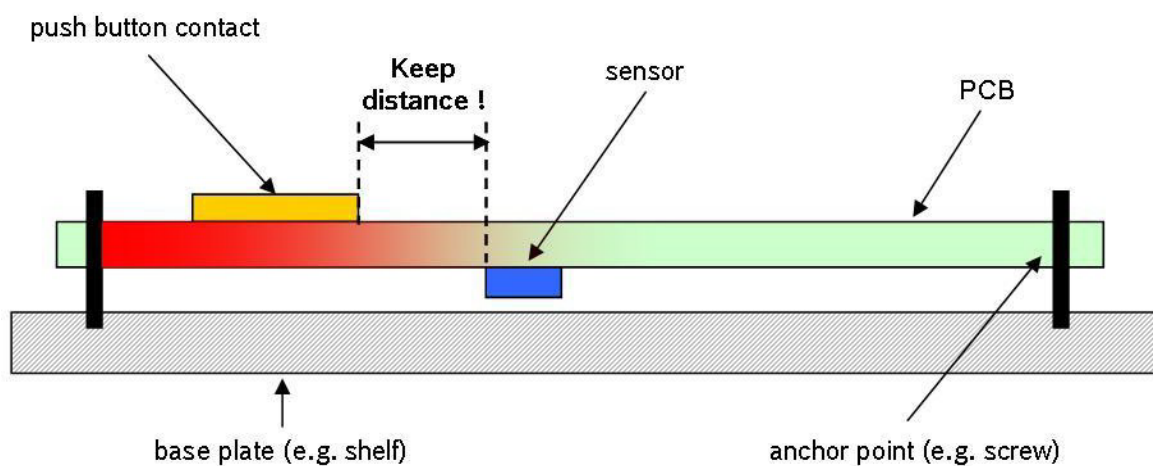


Figure 1: Push-button contacts

3.2 Thermal hot spots on the PCB

Keep a reasonable distance from any thermal hot spots, when placing the sensor device. Hot spots can for example be other integrated circuits with high power consumption.

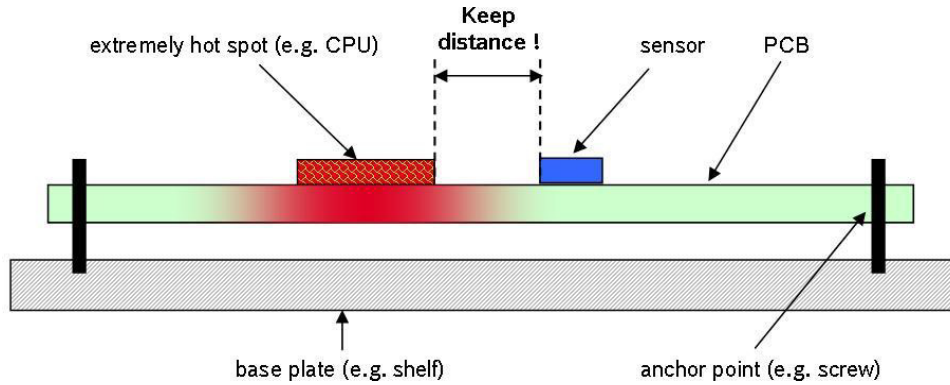


Figure 2: Thermal hot-spots on the PCB

3.3 Distance to PCB anchor points

Keep a reasonable distance from any anchor points, where the PCB is fixed at a base plate (e.g. like a shelf or similar), when placing the sensor device.

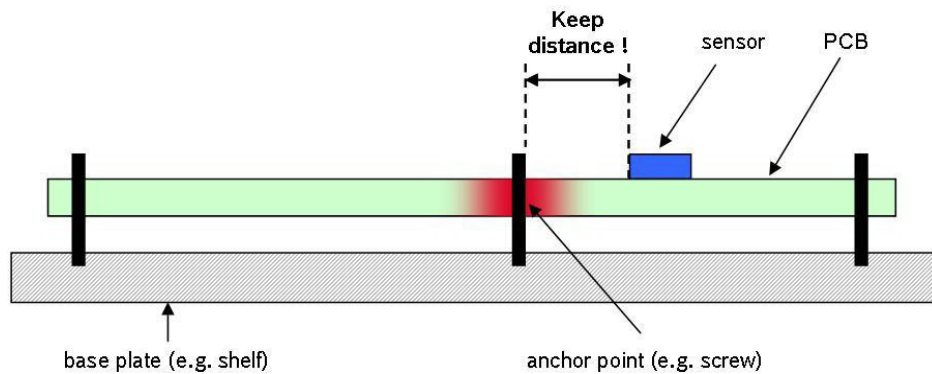


Figure 3: Distance to PCB anchor points

3.4 Vibrations on the PCB

Do not place the sensor in areas where resonant amplitudes (vibrations) of the PCB are likely to occur or to be expected.

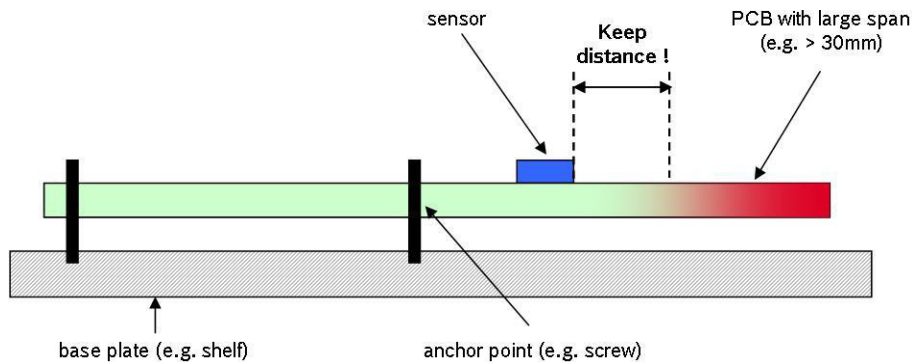


Figure 4: Vibrations on the PCB

3.5 Redundant PCB anchor points

It is recommended to unscrew or remove any redundant PCB anchor points. In theory, an ideal flat plane is determined exclusively by 3 anchor points. Any further anchor point will over-determine the ideal flat plane criteria. If these redundant anchor points are out of plane position (which means not 100% exact in plane position) the ideal flat criteria is infringed, resulting in mechanical stress.

The below given figure describes an expected stress maximum in the center of the diagonal crossover, assuming the 4 anchor points are not 100% exact in plane (over-determined ideal flat plane criteria). Unscrewing or removing one of the redundant anchor points can significantly minimize mechanical stress.

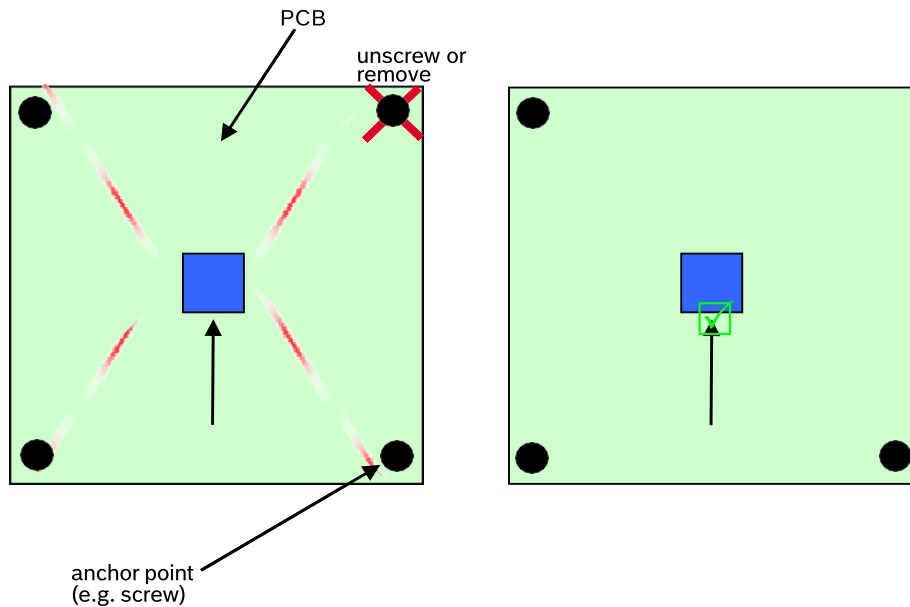


Figure 5: redundant PCB anchor points

3.6 Mechanical stress maximum on the PCB

It is recommended to keep a reasonable distance from any mechanical stress maximum, when placing the sensor device. Mechanical stress can be induced for example by redundant anchor points, as described in 3.5. The below given example will show a stress maximum in the center of the diagonal crossover of the 4 anchor points. It is good manufacturing practice to always avoid or reduce the mechanical stress by optimizing the PCB design first, then to place the sensor in an appropriate low stress area.

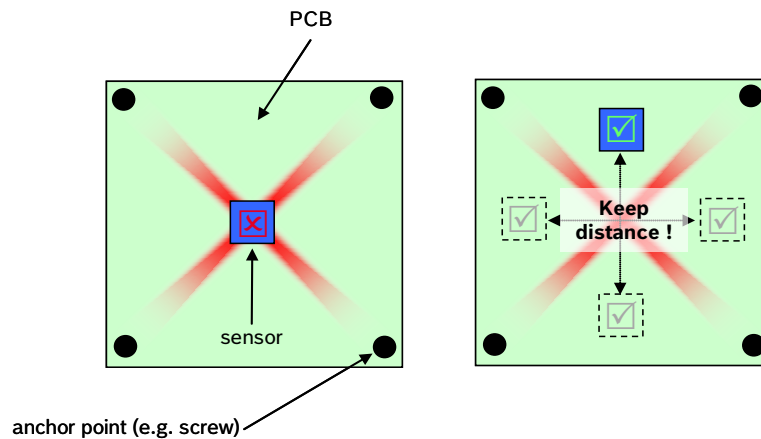


Figure 6: Stress maximum

3.7 Resin coatings

As shown in the figure below, ensure that the sensor is neither partially covered nor in contact with any (epoxy) resin material leading to an un-symmetric stress distribution over the sensor package.

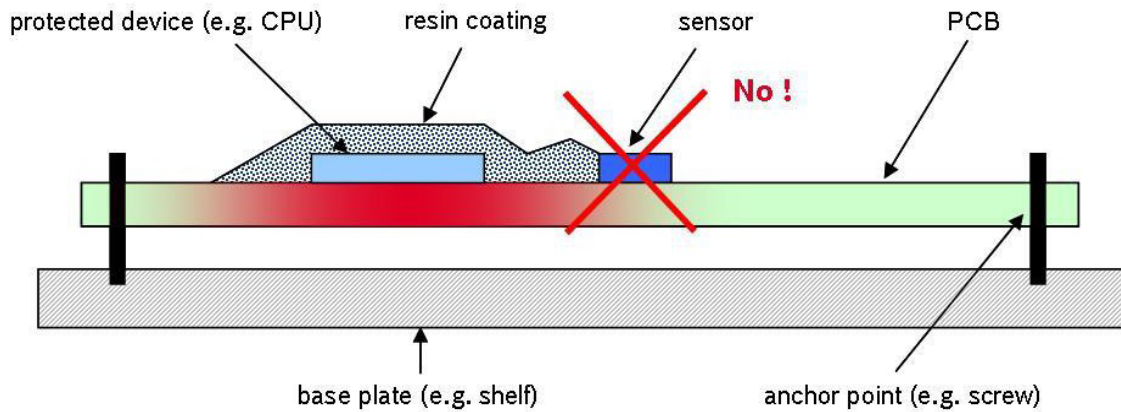


Figure 7: Resin coatings

3.1 RF electric field sources

It is recommended to keep a reasonable distance from high-frequency electric field sources (especially above 2 GHz). Offset shifts and elevated noise may be observed for BMM350 during exposure to E-fields that depend on the strength and frequency of the electric field and the orientation of the field vector to the sensor.

Note that offset observed during E-field exposure scales quadratically with the electric field strength. For example, exposure to a 500 V/m field with a frequency in the range of 2.5 – 4 GHz may lead to offset drift of 1 μ T, exposure to 1 kV/m to an offset drift of 4 μ T.

4 PCB placement guideline based on magnetic influences

4.1 Non-geomagnetic field sources

The magnetic field measured by a geomagnetic sensor is a superposition of earth magnetic field and other environmental influences such as adjacent magnetic materials or fields induced by electric currents.

In this chapter, two other sources will be named, their strength will be compared to that of the geomagnetic field, and the implications for geomagnetic sensor applications will be explained.

The sources relevant for geomagnetic sensor applications are hard ferromagnetic materials and electric currents. Other sources do exist but are not relevant for geomagnetic sensor applications. Please note that the majority of disturbances stemming from the device (adjacent magnetic materials) are effectively compensated by the Sensor fusion software.

4.1.1 On-board: Hard ferromagnetic materials

A hard magnetic material possesses a strong intrinsic magnetisation, which hardly reacts to external fields. These materials are typically used in speaker magnets and electrical motors (which are used for vibration alarm). Many different hard magnetic materials alloys exist. Some low-cost materials are ferrites (BaFeO, SrFeO, ...) and AlNiCo; high-performance materials are for example SmCo and NdFeB.

The field strength of these fields is temperature dependent. For the popular low-cost ferrite magnets, the field decreases on rising temperature at a rate of typically 0.2 %/K; most other materials have a lower temperature coefficient. When operating a geomagnetic sensor in a ferrite-caused offset field of 500 μT , the offset will shift by 10 μT on a change of 10°C (18°F). If not detected, this will cause a major miscalculation of heading.

4.1.2 On-board: Current-induced fields

Magnetic fields occur around electrical currents. The field direction follows the right-hand rule, which is depicted in Figure 8.

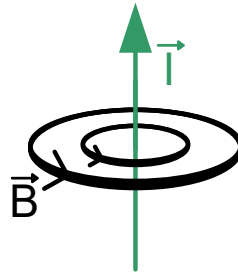


Figure 8: The right-hand rule for current-induced magnetic fields

The absolute magnetic field strength B at a given point outside of the wire depends on the current flowing through the wire and the distance to its centre according to the following formula:

$$B = \mu_0 \cdot \mu_r \cdot \frac{I}{2\pi r} \text{ where}$$

μ_r = relative permeability ≈ 1 for air, and
 μ = vacuum permeability = $4\pi \cdot 10^{-7} \text{ H m}$

Equation 1

As an example, a power line on a PCB could carry a current of 100 mA. At a distance of 5 mm from this line, the magnetic field strength equals:

$$B = \mu_0 \cdot \mu_r \cdot \frac{I}{2\pi r} = 4\pi \cdot 10^{-7} \frac{\text{H}}{\text{m}} \cdot 1 \cdot \frac{100\text{mA}}{2\pi \cdot 5\text{mm}} = 4\mu\text{T}$$

Equation 2

As a typical value for the horizontal geomagnetic field strength is 20 μT , a current-induced field can strongly influence heading calculation results, so that some distance must be kept. However, this is only the case for high-current lines, signals lines (e.g. an SPI bus) do not cause distortions.

4.1.3 Comparison of geomagnetic field strength to other fields

The geomagnetic field is very weak compared to other sources of magnetism. A typical speaker magnet can generate a field of 11,000 μT , which by far exceeds the strength of the earth magnetic field. The calculation above shows that, at least at close distances, current-induced fields can generate fields with strengths similar to the geomagnetic field.

4.2 Distortion and shielding by soft magnetic materials

The measurement of the earth magnetic field is not only affected by the existence of the other field sources named in chapter 5.1, but also the materials that can distort the surrounding fields. These materials are called soft magnetic

materials. Unlike hard magnetic materials, these materials easily change their magnetization based on the surrounding fields and attract the magnetic field lines. This leads to two phenomena: distortion and shielding.

4.2.1 On-board: Distortion

For a geomagnetic sensor, distortion is the effect that the field lines near soft magnetic materials are ‘bent’, so that their direction is changed from large-scale geomagnetic field direction. An example is given in Figure 9, where this field visible to the sensor is not pointing in the direction of magnetic north anymore. In addition, many soft magnetic materials are anisotropic, which means that the behavior depends on the direction of the field applied.

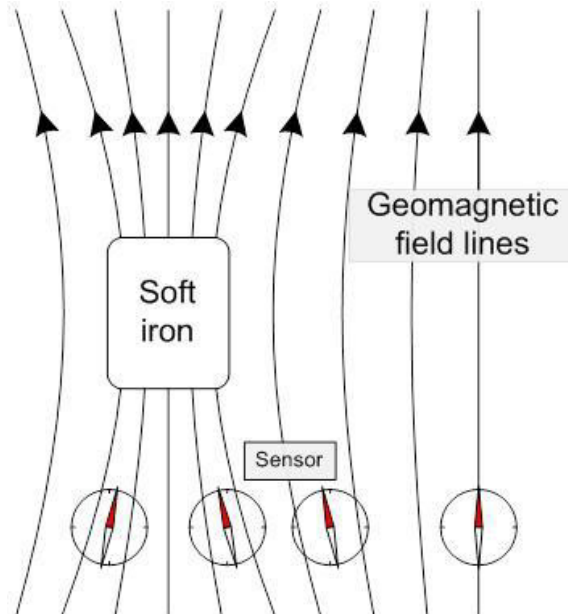


Figure 9: Magnetic field distortion due to soft iron effects

Software compensation of this effect is very difficult. For maritime applications, geomagnetic sensors are calibrated to correct the soft magnetic effects of the ship’s iron. If no precise calibration is possible, such as in consumer applications, soft magnetic materials should be avoided in the vicinity of geomagnetic sensors.

4.2.2 On-board and external: Shielding

If a space is surrounded by soft magnetic material (solid or framework), this surrounding will absorb the magnetic field lines. This is depicted in Figure 10. As a result, there will be virtually no remaining field within the structure. If this effect is desired, the materials like the commercially available Mu-metal can be used as magnetic shielding.

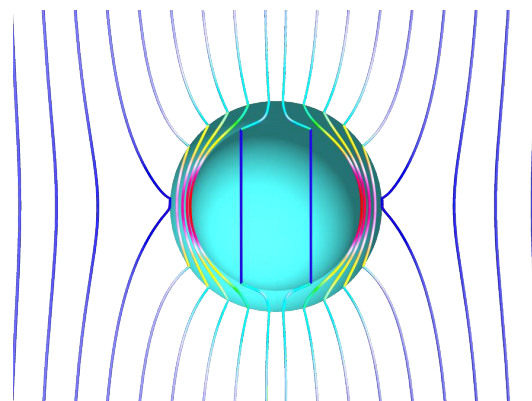


Figure 10: Magnetic shielding within a soft magnetic sphere (source: Institute for Theory of electrical Engineering, Universität Stuttgart)

A geomagnetic sensor cannot work without the external magnetic field. Hence, the better the shielding is, the less signal is available for the geomagnetic sensor to work with. Especially the iron frame of buildings can be an unwanted cause of magnetic shielding. This explains why geomagnetic sensor performance can suffer within a building containing steel.

4.2.3 Overview of external influences

In this chapter, many possible external influences to geomagnetic sensor performance have been discussed. For a better overview, the impact on geomagnetic sensor input will now be given in Figure 11, in which the field in X and Y direction over a 360° geomagnetic sensor rotation is depicted. A centered circle depicts ideal geomagnetic sensor input; the distortions are clearly visible.

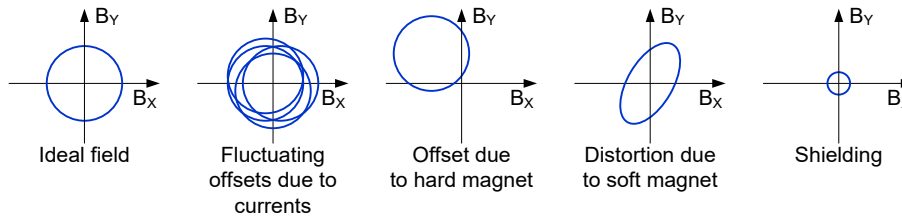


Figure 11: Overview of the effects of external influences on geomagnetic sensor input

4.3 Possibilities and limitations of software compensation

The effects mentioned in the previous chapter can partially be corrected by software.

On-board hard magnetic offsets are almost unavoidable in most of the environment and therefore it needs a calibration phase. In this calibration phase, the offset is estimated so that it can be subtracted from further measurements. This initial calibration is depicted in Figure 12

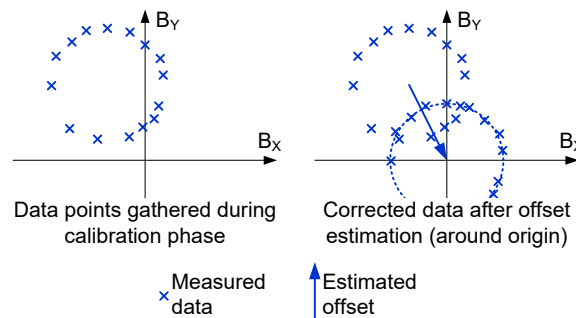


Figure 12: Offset estimation in calibration phase.

However, if the hard magnetic offsets exceed the sensor range, the sensor will become saturated, and heading cannot be measured anymore.

The temperature dependence of the hard magnetic offsets will cause the originally estimated offset to change when temperature changes. If the sensor does not see many different orientations after the original calibration, this change may go unnoticed and result in a significant error (e.g. ~15° heading error on 5°C change of a 500 µT offset magnet).

Figure 13 illustrates this. The center of the blue circle is the offset caused by permanent magnets. The radius of the blue circle equals the magnitude of the earth magnetic field.

The blue x marks the measured field strength. This is going directly in +y direction from the circle's center. The correct heading can only be estimated after the circle's center has been moved to the axes' origin (second image). When the offset changes (third image), while the offset compensation still subtracts the same value, the estimated heading is again wrong.

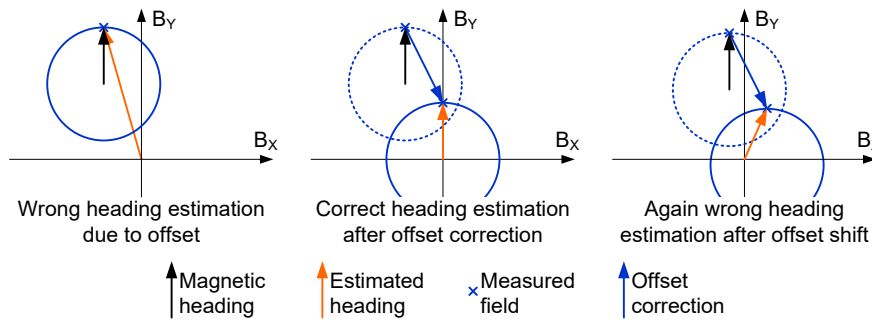


Figure 13: Errors caused by changing magnetic offsets

On-board current-induced fields change unpredictably (e.g., on display brightness change, during network activity ...). Because of this, their effects cannot be compensated, and the fields will appear to add small varying offsets (appearing like noise) or large offsets to the sensor signal.

On-board soft magnetic effects are very difficult to compensate for. Since soft magnetic materials can distort or bend the geomagnetic field in different directions, depending on temperature, field strength and magnetic history of the material involved, a very large data set would be required to estimate all magnetic effects.

For these reasons, soft magnetic materials must (and can) be avoided in the vicinity of a geomagnetic sensor instead of being compensated in software.

On-board or external shielding due to on-board soft magnetic cover or external iron in buildings can attenuate the earth magnetic field so much that it becomes almost immeasurable. External effects cannot be estimated by the compass software and therefore cannot be compensated. On-board shielding will still dampen the signal so much that reliable heading estimation becomes impossible

4.4 PCB placement advice

To achieve optimum geomagnetic sensor performance, several rules need to be kept in order to avoid the disturbances mentioned above.

4.5 Hard magnetic offsets

Hard magnetic offsets must be as limited as much as possible. Ideally, the offset should be below 100 μT , maximum 200 μT . If this is not possible, please refer to the following two rules: **Sensor range may not be exceeded over entire temperature and magnet variation range.** To keep to this rule, the offset at the proposed location should be measured. Then, using information about sample spread and temperature dependence of the magnet(s) that cause(s) this field, the effects over temperature can be estimated.

Example: A ferrite magnet has a temperature dependence of -0.2 %/K. A field of 600 μT measured at 20 °C will grow to $(-0.002 \times (-40 - 20) + 1) \times 600 = 1.12 \times 600 = 672 \mu\text{T}$ at a temperature of -40 °C. To accommodate for magnet variance as well, we recommend not using more than 75 % of the magnetic sensor range at room temperature. This results in the following rule:

$$B_x, B_y, B_z < 0.75 \cdot 1300 \mu\text{T}$$

Equation 3

Not following this rule would result in certain conditions, wherein the sensor range will be exceeded, and geomagnetic sensor functionality will be lost.

External field temperature effects must be minimized. Even if the range of the sensor is large enough to cope with the offset present, its temperature dependence will still impact geomagnetic sensor performance. Recommendation is to have no more than 200µT absolute field strength (i.e., $\sqrt{X^2+Y^2+Z^2}$) assuming a temperature coefficient of -0.2 %/K. if the temperature coefficient is lower, the value of 200 µT can be increased accordingly (e.g., 400 µT for a coefficient of 0.1%/K). This results in the following rule:

$$\sqrt{B_x^2 + B_y^2 + B_z^2} \cdot TC_{\text{magnet}} < 200\mu\text{T} \cdot 0.2\%/K$$

Equation 4

Not following this rule can result in noticeable temperature dependence of the geomagnetic sensor.

4.5.1 PCB Currents

Constant currents on the PCB cause a constant offset on the sens or signal and are compensated by software. However, if fluctuating currents are routed closely to the magnetic sensor, then the changing field strength caused by such a current should not exceed 0.5 µT, while lower numbers are better. Following equation 5, for a given current I_{fluc}, the required distance equals:

$$r = \frac{\mu_0 \cdot \mu_r \cdot I_{fluc}}{2\pi \cdot B} = 0.4 \cdot I_{fluc} \text{ , using}$$

- μ_r = relative permeability ≈ 1 for air,
- μ_0 = vacuum permeability = $4\pi \cdot 10^{-7} \text{ H}\cdot\text{m}$
- I_{fluc} = fluctuating current, and
- B = allowed fluctuating field strength (0.5 µT)

Equation 5

Please use the following table to estimate the required distance between the current line and the geomagnetic sensor:

Table 1: Required distance between magnetic sensor and current lines

Current change (max-min)[mA]	Required distance [mm]
1	0.4
2	0.8
5	2.0
10	4.0
20	8.0
50	20.0

4.5.2 Soft magnetic effects

The usage of soft magnetic materials close to the geomagnetic sensor must be avoided. The presence of soft magnetic materials at the sensor can be estimated by rotating the PCB on a nonmagnetic table (free of iron). Ideally, the measured data points will all be in a circle. In usual cases, soft magnetic effects are visible as distortion of this circle into an ellipse as visible in Figure 14.

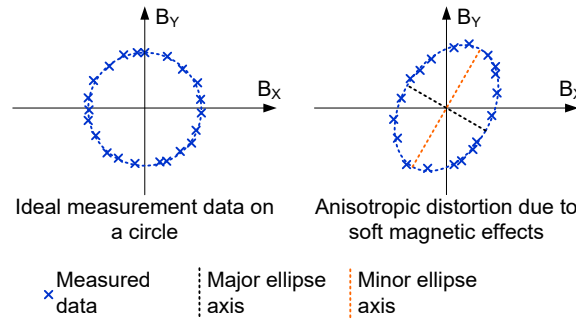


Figure 14: Quantifying soft magnetic distortion

If the distortion can be approximated by an ellipse, the ratio between major and minor ellipse axis defines the soft magnetic effect. The mismatch should be below 3 %, resulting in the last rule:

$$\frac{L_{major_axis}}{L_{minor_axis}} < 1.03$$

Equation 6

4.5.3 Overview

An overview of the previously presented rules is shown in the table below

Table 2: Overview of placement guidelines

Hard magnetism	
Ideal:	External field < 100 μT
Second best:	External field < 200 μT
Otherwise:	External field < 0.75 x sensor range (room temperature), and sqrt(BX ² +BY ² +BZ ²) x TCext. field < 0.40 μT x %/K
Fluctuating PCB currents	
Distance r [mm]	> 0.4 x Ifluc [mA]
Soft magnetism	
Ratio major axis / minor axis	< 1.03

5 PCB layout recommendation

5.1 Dimensions and landing pattern recommendation

Find information on the landing pattern and sensor dimensions below.

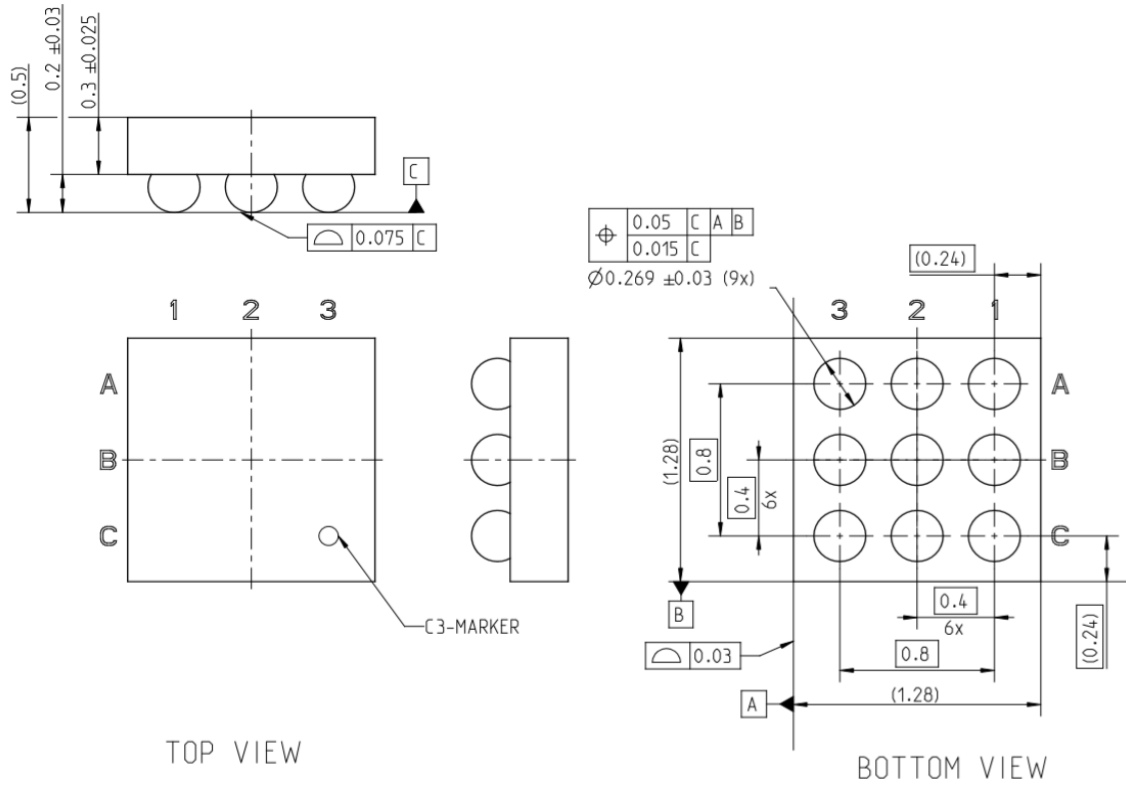


Figure 15: BMM350 package dimensions

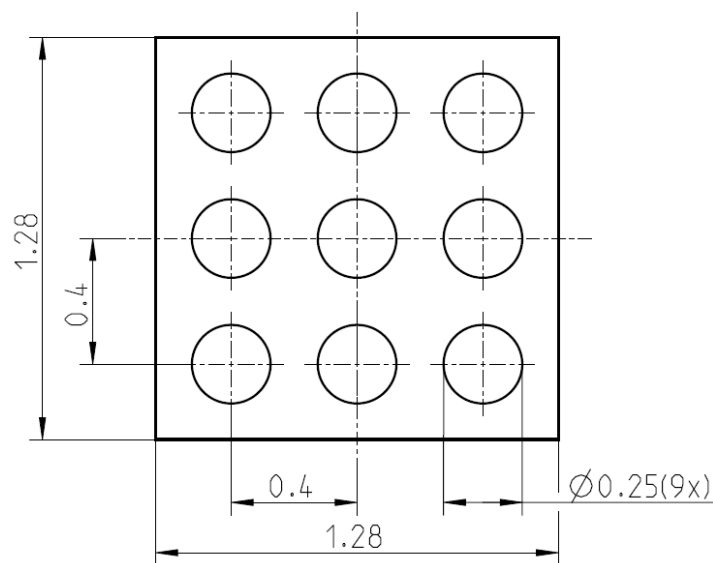


Figure 16: Recommended landing pattern for soldering to PCB.

5.2 Connection diagram

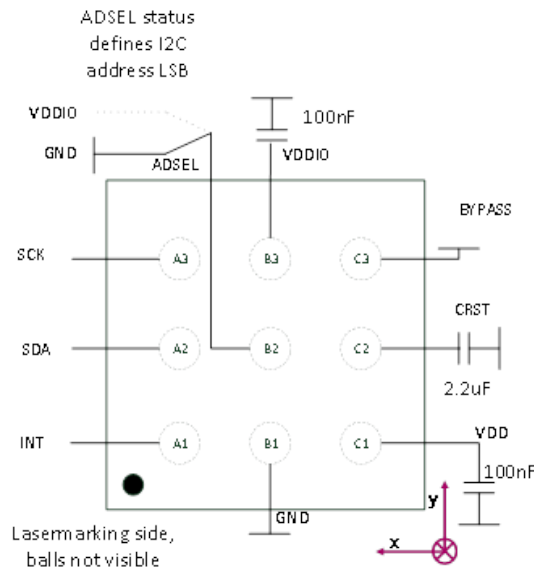


Figure 17: BMM350 connection diagram (TOP view).

- 100nF capacitors should be used for VDD and VDDIO decoupling.
- CRST requires a 2.2uF capacitor (200mA peak current, need low resistance, low inductance type with non-magnetic properties). For part recommendations please refer to the BM350 data sheet.

5.3 Layout recommendations

The central ADSEL pin can be directly routed to GND or VDDIO for address selection. It can also be connected externally using a blind via in case address selection is desired, however, large vias and a mixed VIPP / non-VIPPO design should be avoided, as the thermal expansion of the via during soldering can lead to a risk of voiding in the center pin.

The following peak current can flow:

- 400mA current (very short time < 1us) between CRST capacitor (2.2uF) and CRST pin
- 400mA current (very short time < 1us) between CRST capacitor (2.2uF) and GND pin
- 20mA max current (short time, < 10ms) in VDD pin, 750uA maximum average current

6 Reflow Soldering & Moisture Sensitivity Level

To ensure that sensors are properly mounted it is important to avoid mechanical stress by ensuring a proper solder thickness after soldering. Furthermore, solder paste thickness after soldering should be as uniform as possible to reduce stress.

The **moisture sensitivity level** (MSL) of the device corresponds to JEDEC **Level 1**, see also

- IPC/JEDEC J-STD-020D "Joint Industry Standard: Moisture/Reflow Sensitivity Classification for non-hermetic Solid State Surface Mount Devices"
- IPC/JEDEC J-STD-033D "Joint Industry Standard: Handling, Packing, Shipping and Use of Moisture/Reflow Sensitive Surface Mount Devices"

For Qualification of the sensor, the reflow profile according to JEDEC J-STD020 D is used. This profile has proven to work well with the geometry and ball size of the part.

The used solder paste in the standard process is a lead-free no-clean solder paste, with a stencil height of 80 µm.

Note that the sensor performance was characterized **without** application of underfill, glue or encapsulation. Changes in performance may occur in case an underfill, glue or encapsulation is used, especially under strain and/or thermal stress.

The product can withstand in total up to 3 reflow soldering cycles. This could be a situation where a PCB is mounted with devices from both sides (i.e., 2 reflow cycles necessary) and in the next step an additional re-work cycle could be required (1 reflow).

7 Wafer Level Chip Scale Package Handling

Since BMM products in Wafer Level Chip Scale Package have no EMC mold protection they should be handled with great care. The devices should remain secure in their carriers except during unloading or inspection operations at dedicated ESD-safe workplaces. WLCSP parts should not be handled with bare hands, even wearing gloves or finger cots.

In cost driven assembly builds like low volume productions and engineering runs, manual handling of the devices may be necessary. In these cases, it is mandatory that tweezers of any form are **not** used to pick up, transfer or place the WLCSP. Tweezers often cause mechanical damage to the WLCSP, either to the top surface or to the silicon. Scratches, chip-out, and micro-cuts are hard to avoid using tweezers of any form. This kind of damage maybe visible but often does not manifest until electrical testing. Therefore, it is recommended that any manual handling is done by using suitable designed tools such as vacuum pencils with PTFE tips for sawn-edge pick-up.

For automatic pick and place equipment a soft silicon/rubber tip of suitable size should be used. These tips should be inspected and cleaned in well-defined periods to avoid mechanical damage to the chip. The operating pressure of the pick and place tool should be minimized.

8 Handling of reels

8.1 Storage

Once the reels are removed from the pizza box, they should always be stacked in vertical condition.

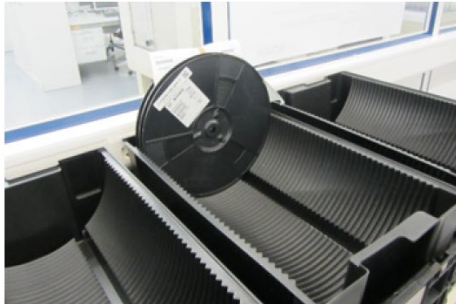
8.2 Introduction into production

Reel trailers must not be removed. Removal of the trailer could cause deformation of the reel during de-reeling and consequently tilted parts

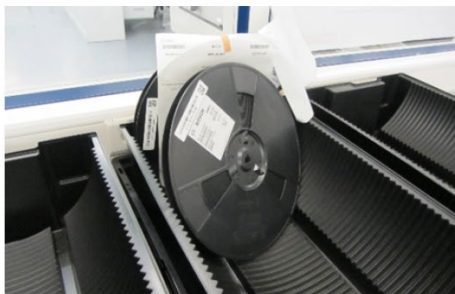


Figure 18: Reel trailers must not be removed

Reels must be stored vertically as shown in the image below



✓
Correct Storage.



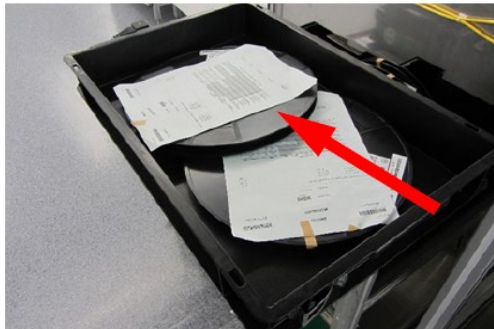
✗
Wrong Storage.

Figure 19: Reels must be stored vertically as shown

When reels are to be stored horizontally, they must be ordered in a stack with at most 4 reels per stack (see images below).



✓
Correct Storage.



✗
Wrong Storage.

Figure 20: Stacking of reels

8.3 Orientation of sensors on the reel

The orientation of the sensors on the reel is shown in Figure 21.

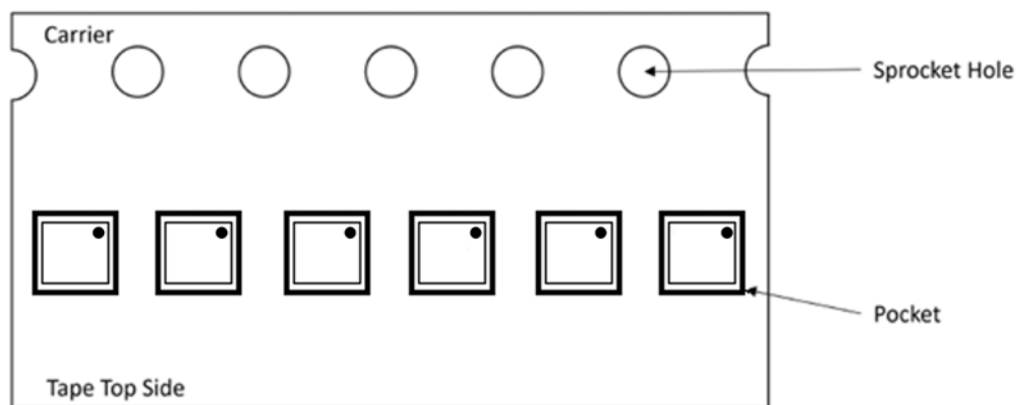


Figure 21: Orientation of sensors on the reel. Pin 1 (“INT”) marker at upper left position

8.4 Reel Dimensions

Notes:

(*) 10 sprocket hole pitch cumulative tolerance ± 0.2

(**) Pocket position relative to sprocket hole measured as true position of pocket, not pocket hole

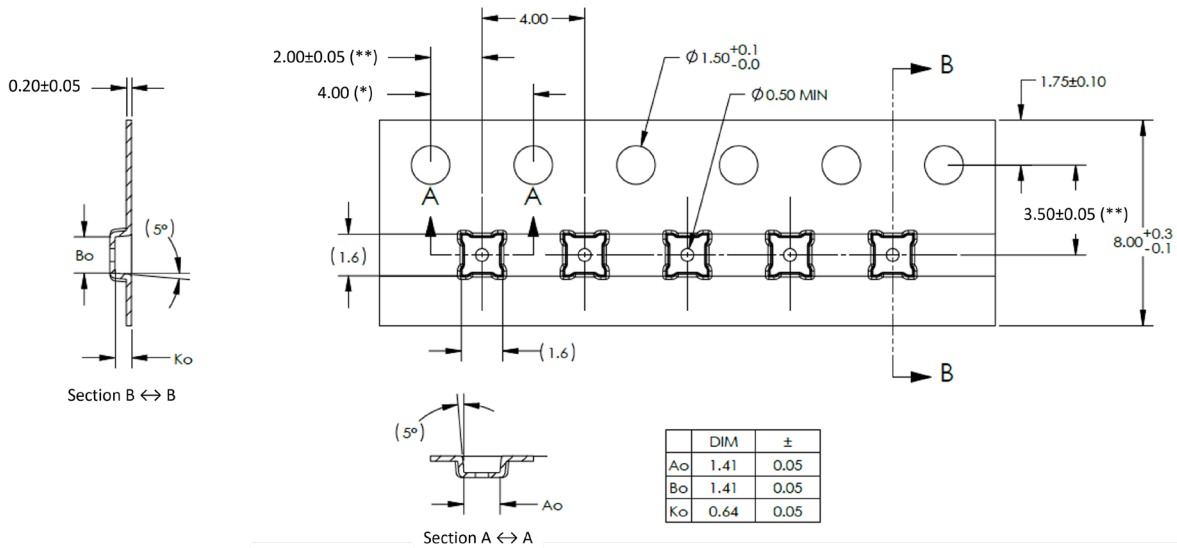


Figure 22: Reel dimensions

9 Returning WLCSP for Failure Analysis

WLCSPs can be easily damaged while removing the part from the assembly either because of de-soldering (thermal stress) or handling (mechanical stress).

In case a part needs to be returned to BST for failure analysis (FA) purposes, please send the PCB on which the part is assembled. If not possible, carefully cut a larger area around the part while avoiding warpage of the assembly and return it to BST. For shipment, use material and packaging that protects against electro-static discharge (ESD) and mechanical damage, e.g., place the part into an ESD bag, wrap the bag in foam material and ship in a stable package.

This procedure is required to ensure that the FA can be conducted at BST.

Note: If any underfill or encapsulation was used (not recommended, see Chapter 6) and the part needs to be returned to BST for FA, please provide details on the type of material used for the underfill/ encapsulation (silicone based etc.) to facilitate chemical removal at BST for FA.

In case the part must be removed from the PCB, please get in contact with BST to receive a guideline on how to safely de-solder WLCSPs.

10 Environmental Safety

10.1 RoHS

The BMM350 sensor meets the requirements of the EC restriction of hazardous substances (RoHS) directive, see also: Directive 2002/95/EC of the European Parliament and of the Council of 8 September 2011 on the restriction of the use of certain hazardous substances in electrical and electronic equipment.

10.2 Halogen content

The BMM350 is halogen-free. For more details on the analysis results please contact your Bosch Sensortec representative.

11 Legal Disclaimer

11.1 Engineering samples

Engineering Samples are marked with an asterisk (*), (e) or (E). Samples may vary from the valid technical specifications of the product series contained in this data sheet. They are therefore not intended or fit for resale to third parties or for use in end products. Their sole purpose is internal client testing. The testing of an engineering sample may in no way replace the testing of a product series. Bosch Sensortec assumes no liability for the use of engineering samples. The Purchaser shall indemnify Bosch Sensortec from all claims arising from the use of engineering samples.

11.2 Product use

Bosch Sensortec products are developed for the consumer goods industry. They may only be used within the parameters of this product data sheet. They are not fit for use in life-sustaining or safety-critical systems. Safety-critical systems are those for which a malfunction is expected to lead to bodily harm, death or severe property damage. In addition, they shall not be used directly or indirectly for military purposes (including but not limited to nuclear, chemical or biological proliferation of weapons or development of missile technology), nuclear power, deep sea or space applications (including but not limited to satellite technology).

The resale and/or use of Bosch Sensortec products are at the purchaser's own risk and his own responsibility. The examination of fitness for the intended use is the sole responsibility of the purchaser.

The purchaser shall indemnify Bosch Sensortec from all third-party claims arising from any product use not covered by the parameters of this product data sheet or not approved by Bosch Sensortec and reimburse Bosch Sensortec for all costs in connection with such claims.

The purchaser accepts the responsibility to monitor the market for the purchased products, particularly with regard to product safety, and to inform Bosch Sensortec without delay of all safety-critical incidents.

11.3 Application examples and hints

With respect to any examples or hints given herein, any typical values stated herein and/or any information regarding the application of the device, Bosch Sensortec hereby disclaims any and all warranties and liabilities of any kind, including without limitation warranties of non-infringement of intellectual property rights or copyrights of any third party. The information given in this document shall in no event be regarded as a guarantee of conditions or characteristics. They are provided for illustrative purposes only and no evaluation regarding infringement of intellectual property rights or copyrights or regarding functionality, performance or error has been made.

12 Document history and modification

Rev. No	Chapter	Description of modification/changes	Date
1.0	all	Initial release	September 2021
1.3	all	Revision	April 2023
1.4	8.3	Orientation of sensor in reel	May 2023

Bosch Sensortec GmbH

Gerhard-Kindler-Straße 9
72770 Reutlingen / Germany

contact@bosch-sensortec.com
www.bosch-sensortec.com

Modifications reserved

Preliminary - specifications subject to change without notice

Document number: BST-BMM350-HS000-04