

Display Elektronik GmbH

DATA SHEET

TFT MODULE

DEM 1920720C VMX-PW-N

12,3" TFT

Product Specification

Ver.: 0

21.11.2019

Revision History

Revision	Date	Originator	Detail	Remarks
0	21.11.2019	ZDT	Initial Release	

Table of Contents

No.	Item	Page
1.	General Description	4
2.	Module Parameter	4
3.	Absolute Maximum Ratings	4
4.	DC Characteristics	5
5.	Backlight Characteristic	5
5.1.	Backlight Characteristic	5
5.2.	Backlighting Circuit	5
6.	Optical Characteristics	6
6.1.	Optical Characteristics	6
6.2.	Definition of Response Time	6
6.3.	Definition of Contrast Ratio	7
6.4.	Definition of Viewing Angles.....	7
6.5.	Definition of Color Appearance	8
6.6.	Definition of Surface Luminance, Uniformity and Transmittance.....	8
7.	Block Diagram and Power Supply	9
8.	Interface Pins Definition	10
9.	SIGNAL SPECIFICATION	12
10.	POWER ON/OFF SEQUENCE	13
11.	Quality Assurance	14
11.1.	Purpose.....	14
11.2.	Standard for Quality Test.....	14
11.3.	Nonconforming Analysis & Disposition	14
11.4.	Agreement Items.....	14
11.5.	Standard of the Product Visual Inspection	14
11.6.	Inspection Specification	16
11.7.	Classification of Defects.....	19
11.8.	Identification/marketing criteria	19
11.9.	Packing	19
12.	Reliability Specification	20
13.	Precautions and Warranty	21
13.1.	Safety	21
13.2.	Handling.....	21
13.3.	Storage.....	21
13.4.	Metal Pin (Apply to Products with Metal Pins)	21
13.5.	Operation	22
13.6.	Static Electricity	22
13.7.	Limited Warranty	22
14.	Outline Drawing	23

1. General Description

The specification is a transmissive type color active matrix liquid crystal display (LCD) which uses amorphous thin film transistor (TFT) as switching devices. This product is composed of a TFT-LCD panel, driver ICs and a backlight unit.

2. Module Parameter

Features	Details	Unit
Display Size(Diagonal)	12.3"	
Display Mode	Transmissive /Normally Black	
Resolution	1920 x RGB x 720	Pixels
View Direction	FULL VIEW	Best Image
Module Outline	307.00 x 125.90 x 10.70 (Note1)	mm
Active Area	292.032 x 109.512	mm
Pixel Pitch	0.1521 x 0.1521	mm
Pixel Arrangement	RGB Vertical Stripe	
Display Colors	16.7 Million	
Interface	Dual-LVDS Interface	
Driver IC	HX8290 & HX8695	-
With or without the Touch Panel	Without	
Operating Temperature	-30~85	°C
Storage Temperature	-40~90	°C
Weight	TBD	g

Note 1: Inclusive hooks, posts, FFC/FPC tail etc.

3. Absolute Maximum Ratings

$V_{SS}=0V$, $T_a=25^{\circ}C$

Item	Symbol	Min.	Max.	Unit
Power Supply Voltage	VCC	-0.3	4.0	V
Storage Temperature	T_{STG}	-40	90	°C
Operating Temperature	T_{OP}	-30	85	°C

Note 1: If T_a below $50^{\circ}C$, the maximal humidity is 90%RH, if T_a over $50^{\circ}C$, absolute humidity should be less than 60%RH.

Note 2: The response time will be extremely slow when the operating temperature is around $-10^{\circ}C$, and the back ground will become darker at high temperature operating.

4. DC Characteristics

Item	Symbol	Min.	Typ.	Max.	Unit
Supply Voltage	VCC	3.0	3.3	3.5	V
Differential Input High Threshold Voltage	V _{TH}	+0.1	-	-	V
Differential Input Low Threshold Voltage	V _{TL}	-	-	-0.1	V
Differential Input Common Mode Voltage	V _{CM}	1	1.2	1.7- Vid /2	V
LVDS Input Voltage	V _{INLV}	0.7	-	1.7	V
Differential Input Voltage	Vid	0.2	-	0.6	V
Differential Input Leakage Current	I _{Ileak}	-10	-	+10	μA

5. Backlight Characteristic

5.1. Backlight Characteristic

Item	Symbol	Condition	Min.	Typ.	Max.	Unit
Forward Voltage	V _F	T _a =25 °C, I _F =100mA/LED	24.3	27.9	30.6	V
Forward Current	I _F	T _a =25 °C, V _F =3.1V/LED	-	400	-	mA
Power Dissipation	P _D	-	-	11160	-	mW
Uniformity	Avg	-	70	80	-	%
LED Lifetime (25°C)	-	-	-	15000	-	Hrs
Drive Method	Constant Current					
LED Configuration	36 White LEDs (9 LEDs in one string and 4 groups in parallel)					

Note1: LED life time defined as follows: The final brightness is at 50% of original brightness.
 The environmental conducted under ambient air flow, at T_a=25± 2 °C,60%RH± 5%,
 I_F=100mA/LED.

5.2. Backlighting Circuit

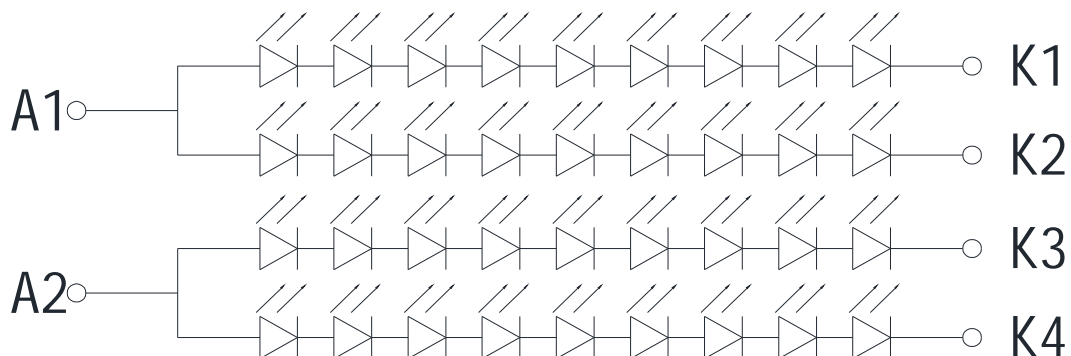

6. Optical Characteristics

6.1. Optical Characteristics

Ta=25°C, VCC=3.3V

	Item	Symbol	Condition	Specification			Unit	
				Min.	Typ.	Max.		
Backlight On (Transmissive Mode)	Luminance On TFT(I _f =100mA/LED)	Lv		800	1000	-	cd/m ²	
	Contrast Ratio(See 6.3)	CR		-	1100	-		
	Response Time (See 6.2)	TR+TF		-	-	25	ms	
	Chromaticity Transmissive (See 6.5)	Red	X _R	Center CR≥10	-	TBD	-	
			Y _R		-	TBD	-	
		Green	X _G		-	TBD	-	
			Y _G		-	TBD	-	
		Blue	X _B		-	TBD	-	
			Y _B		-	TBD	-	
	White	X _W	-	TBD	-			
		Y _W	-	TBD	-			
	Viewing Angle (See 6.4)	Horizontal	θ _{X+}	Center CR≥10	80	88	-	Deg.
			θ _{X-}		80	88	-	
Vertical		φ _{Y+}	80		88	-		
		φ _{Y-}	80		88	-		
NTSC Ratio(Gamut)				-	72	-	%	

6.2. Definition of Response Time

6.2.1. Normally Black Type (Negative)

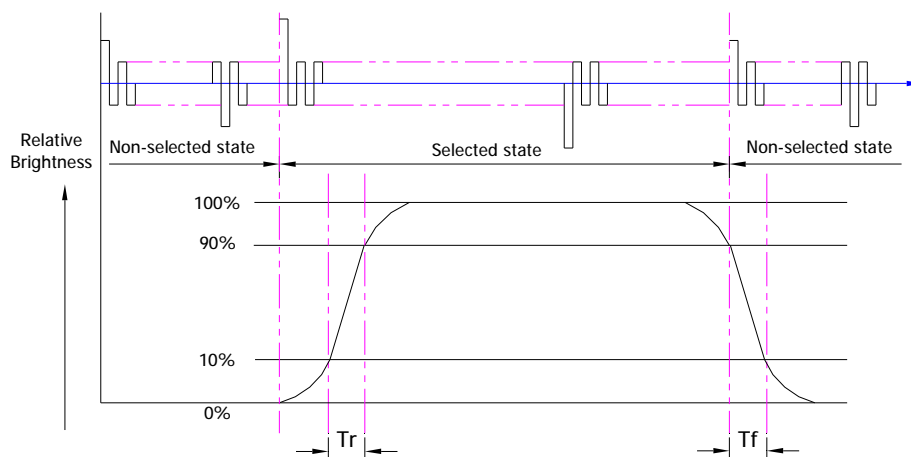

Tr is the time it takes to change from non-selected stage with relative luminance 10% to selected state with relative luminance 90%;

Tf is the time it takes to change from selected state with relative luminance 90% to non-selected state with relative luminance 10%.

Note: Measuring machine: LCD-5100

6.2.2. Normally White Type (Positive)

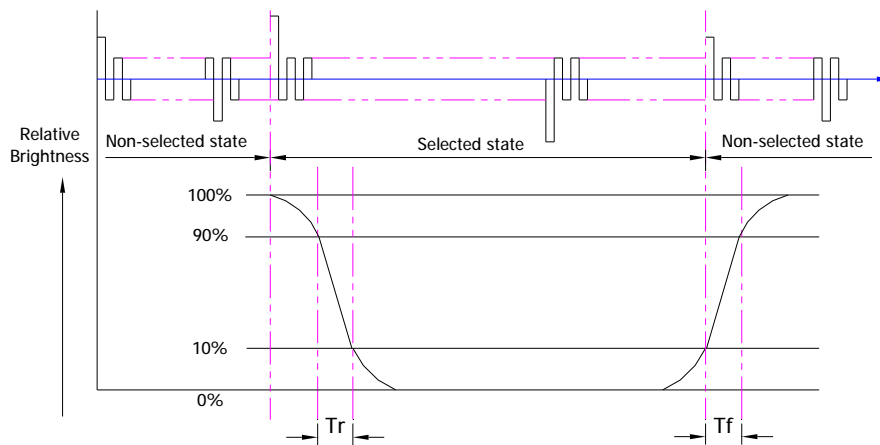

Tr is the time it takes to change from non-selected stage with relative luminance 90% to selected state with relative luminance 10%;

Tf is the time it takes to change from selected state with relative luminance 10% to non-selected state with relative luminance 90%;

Note: Measuring machine: LCD-5100 or EQUI

6.3. Definition of Contrast Ratio

Contrast is measured perpendicular to display surface in reflective and transmissive mode. The measurement condition is:

Measuring Equipment	Eldim or Equivalent
Measuring Point Diameter	3mm//1mm
Measuring Point Location	Active Area centre point
Test Pattern	A: All Pixels white
	B: All Pixel black
Contrast Setting	Maximum

Definitions: CR (Contrast) = Luminance of White Pixel / Luminance of Black Pixel

6.4. Definition of Viewing Angles

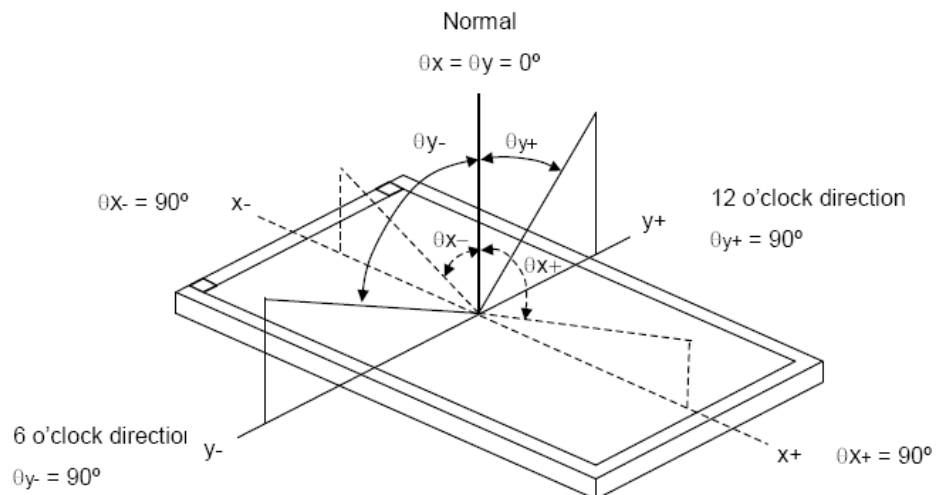

Measuring machine: LCD-5100 or EQUI

6.5. Definition of Color Appearance

R,G,B and W are defined by (x, y) on the IE chromaticity diagram

NTSC=area of RGB triangle/area of NTSC triangleX100%

Measuring picture: Red, Green, Blue and White (Measuring machine: BM-7)

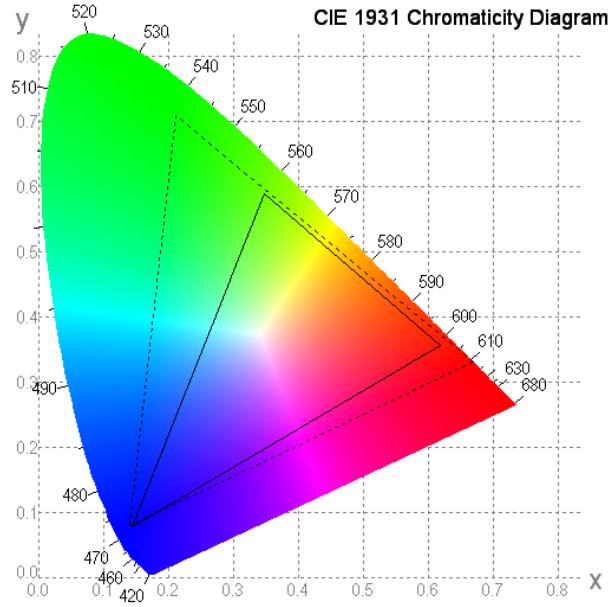

6.6. Definition of Surface Luminance, Uniformity and Transmittance

Using the transmissive mode measurement approach, measure the white screen luminance of the display panel and backlight.

6.6.1. Surface Luminance: $L_v = \text{average} (L_{P1}:L_{P9})$

6.6.2. Uniformity = $\text{Minimal} (L_{P1}:L_{P9}) / \text{Maximal} (L_{P1}:L_{P9}) * 100\%$

6.6.3. Transmittance = $L_v \text{ on LCD} / L_v \text{ on Backlight} * 100\%$

Note: Measuring machine: BM-7

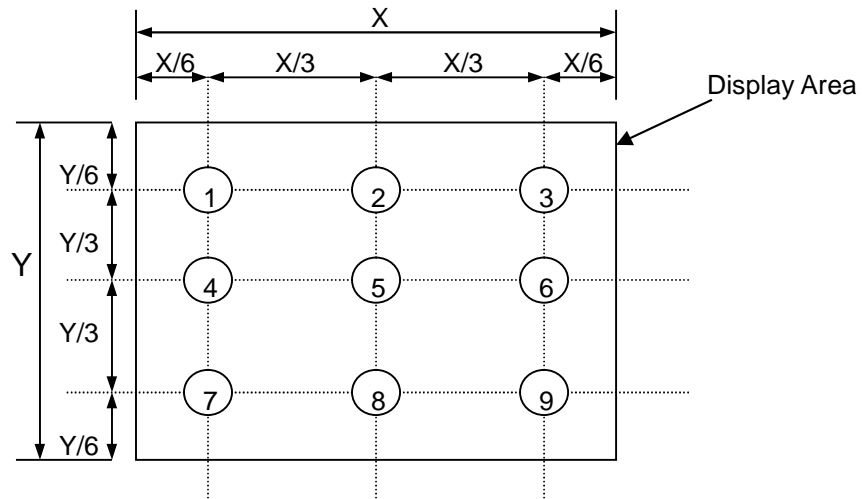

7. Block Diagram and Power Supply

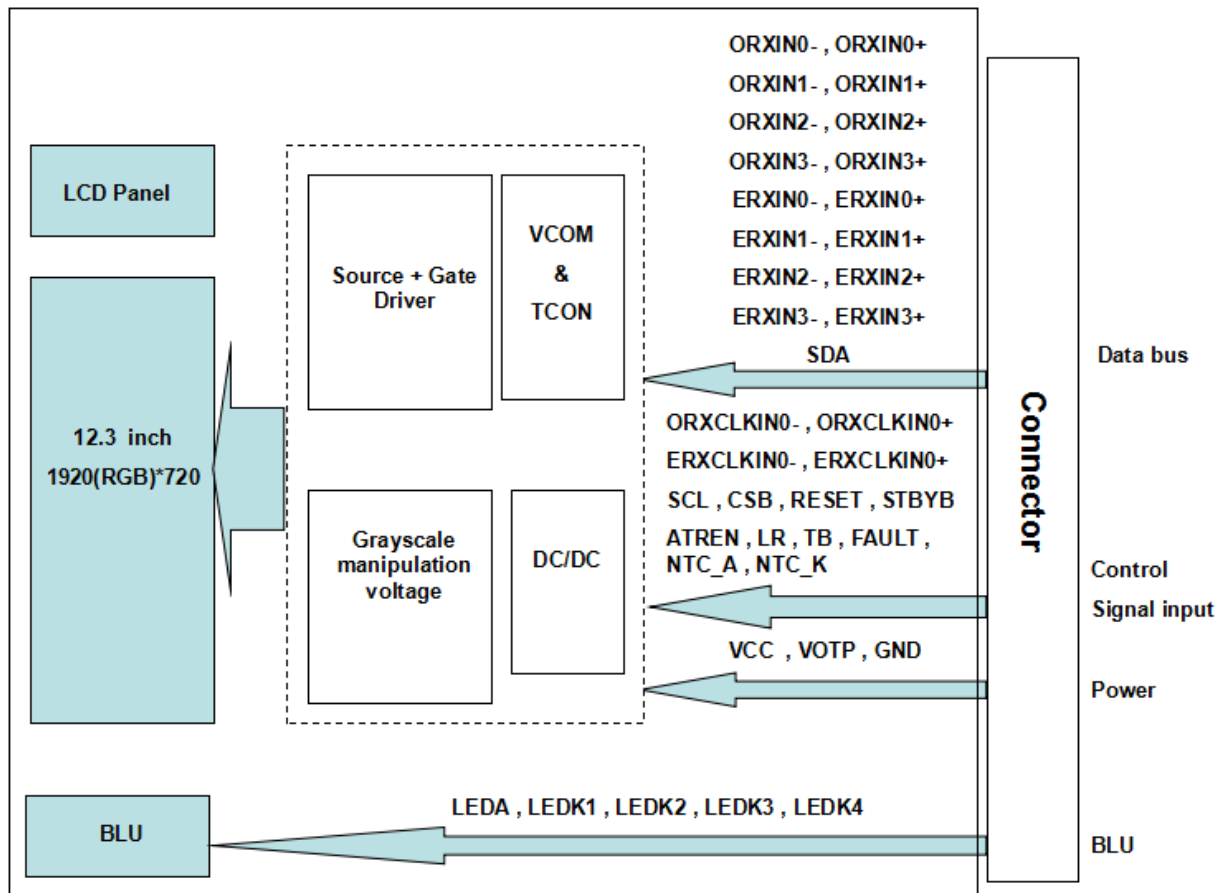

8. Interface Pins Definition

Connector: Hirose FH28-60S-0.5H(05)

No.	Symbol	Function	Remark
1	GND	Ground	
2	VCC	Power Supply	
3	VCC	Power Supply	
4	GND	Ground	
5	ORXIN0-	LVDS Receiver Signal(-)	
6	ORXIN0+	LVDS Receiver Signal(+)	
7	GND	Ground	
8	ORXIN1-	LVDS Receiver Signal(-)	
9	ORXIN1+	LVDS Receiver Signal(+)	
10	GND	Ground	
11	ORXIN2-	LVDS Receiver Signal(-)	
12	ORXIN2+	LVDS Receiver Signal(+)	
13	GND	Ground	
14	ORXCLKIN-	LVDS Receiver Signal(-)	
15	ORXCLKIN+	LVDS Receiver Signal(+)	
16	GND	Ground	
17	ORXIN3-	LVDS Receiver Signal(-)	
18	ORXIN3+	LVDS Receiver Signal(+)	
19	GND	Ground	
20	ERXIN0-	LVDS Receiver Signal(-)	
21	ERXIN0+	LVDS Receiver Signal(+)	
22	GND	Ground	
23	ERXIN1-	LVDS Receiver Signal(-)	
24	ERXIN1+	LVDS Receiver Signal(+)	
25	GND	Ground	
26	ERXIN2-	LVDS Receiver Signal(-)	
27	ERXIN2+	LVDS Receiver Signal(+)	
28	GND	Ground	
29	ERXCLKIN-	LVDS Receiver Signal(-)	
30	ERXCLKIN+	LVDS Receiver Signal(+)	
31	GND	Ground	
32	ERXIN3-	LVDS Receiver Signal(-)	
33	ERXIN3+	LVDS Receiver Signal(+)	
34	GND	Ground	
35	NC	No connection	
36	RESET	Reset Signal	
37	STBYB	STBYB Sign	
38	SCL	SPI Signal	
39	SDA	SPI Signal	
40	CSB	SPI Signal	
41	ATREN	Enable auto reload Single	

42	NC	No connection	
43	VOTP	OTP Voltage	
44	GND	Ground	
45	LR	Horizontal shift direction	Note 1
46	TB	Vertical shift direction	Note 1
47	FAULT	Fault dection	
48	NC	No connection	
49	LEDA	Power Supply of LED	
50	LEDA	Power Supply of LED	
51	NC	No connection	
52	NC	No connection	
53	LEDK1	Ground of LED	
54	LEDK2	Ground of LED	
55	LEDK3	Ground of LED	
56	LEDK4	Ground of LED	
57	NC	No connection	
58	NTC_A	Thermistor Sensor	
59	NC	No connection	
60	NTC_K	Thermistor Sensor	

Note1:

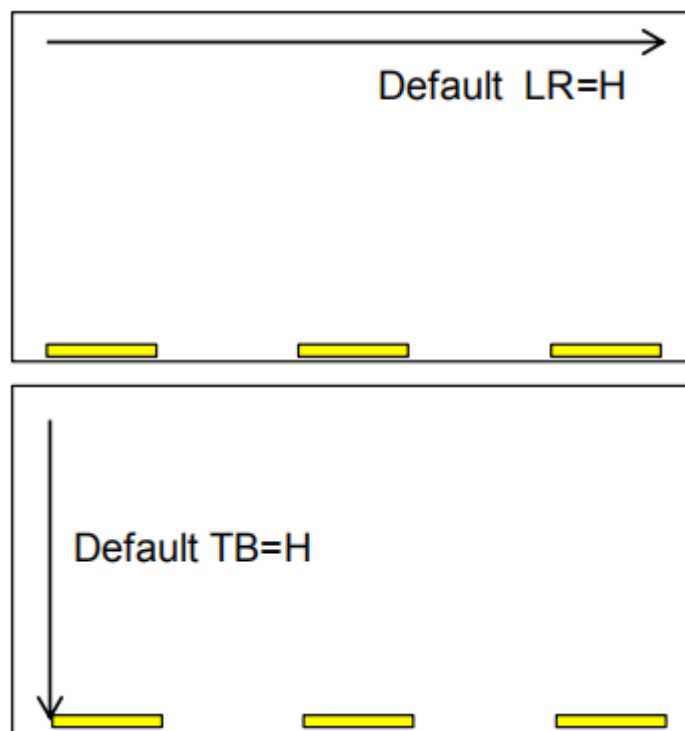

9. SIGNAL SPECIFICATION

1) LVDS Signal Timing

Parameter	Symbol	Min.	Typ.	Max.	Unit	Condition
Clock frequency	RxFCLK		44.1		MHz	
Horizontal Display Area	thd		960		DCLK	
HS Period	th	984	992	1005	DCLK	
HS Blanking	Thb+thfp		32		DCLK	
Vertical Display Area	tvd		720		TH	
VS Period	tv	730	741	753	TH	
VS Blanking	Tvbp+tvfp		21		TH	
Input data skew margin	TRSKM	400			ps	
Clock high time	TLVCH	2.45	3	4.55	ns	
Clock low time	TLVCL	2.45	4	4.55	ns	
PLL wake-up time	TenPLL			150	us	

2) Signal Format

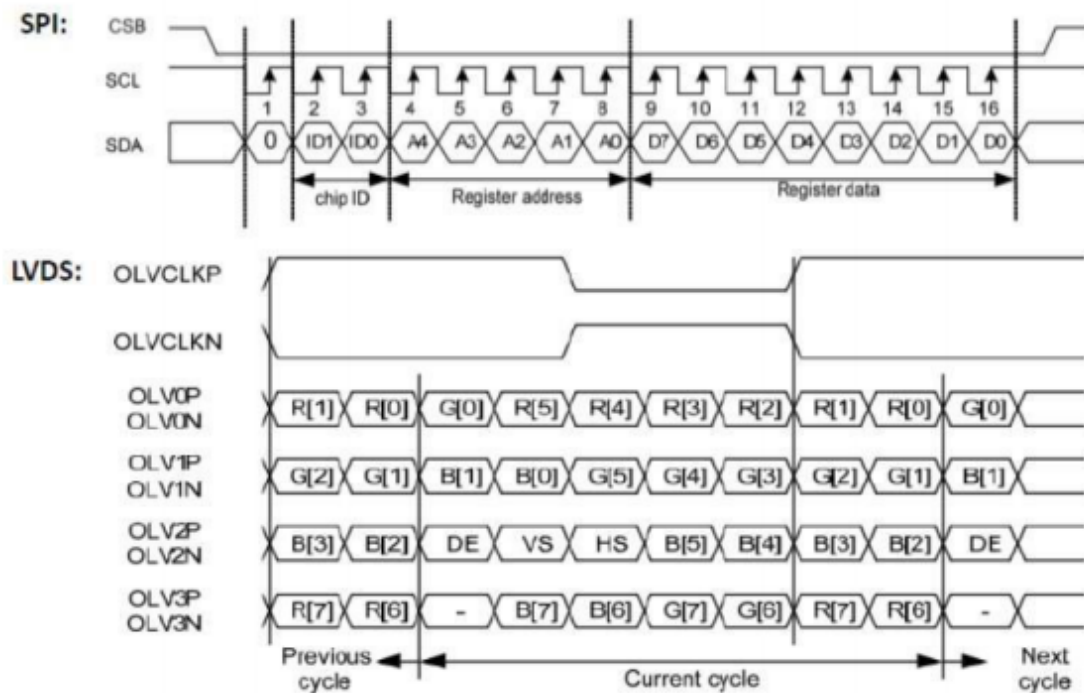

10. POWER ON/OFF SEQUENCE

1) Power on sequence

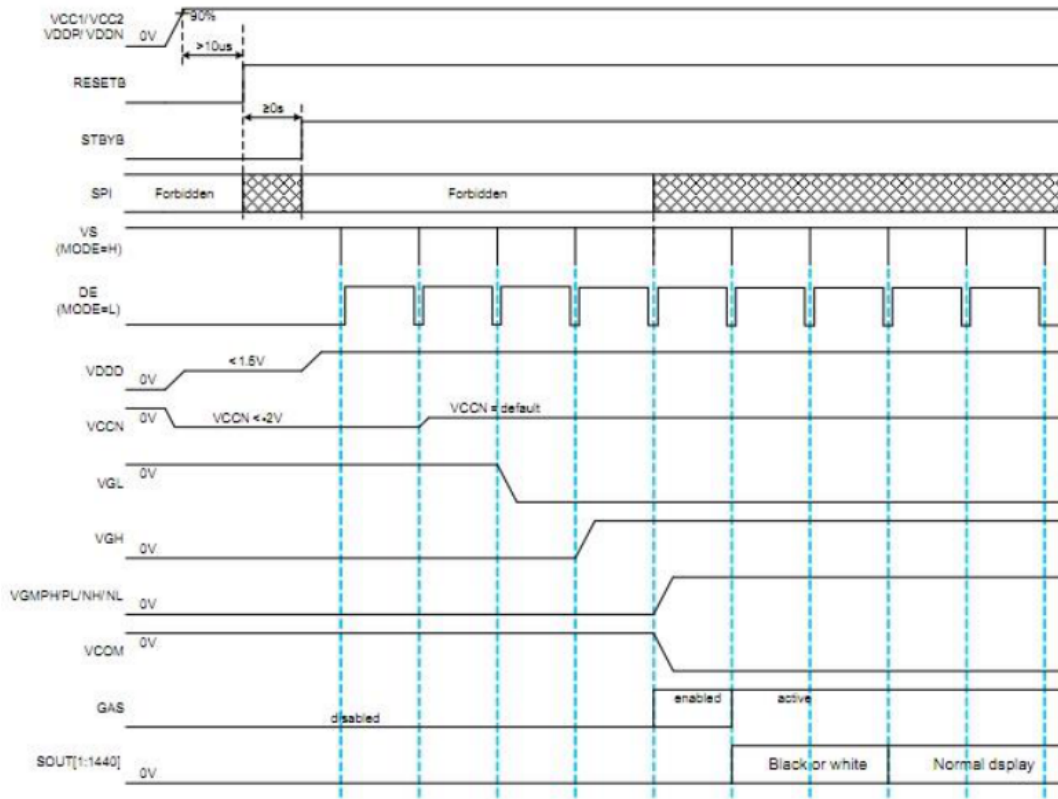

2) Power off sequence

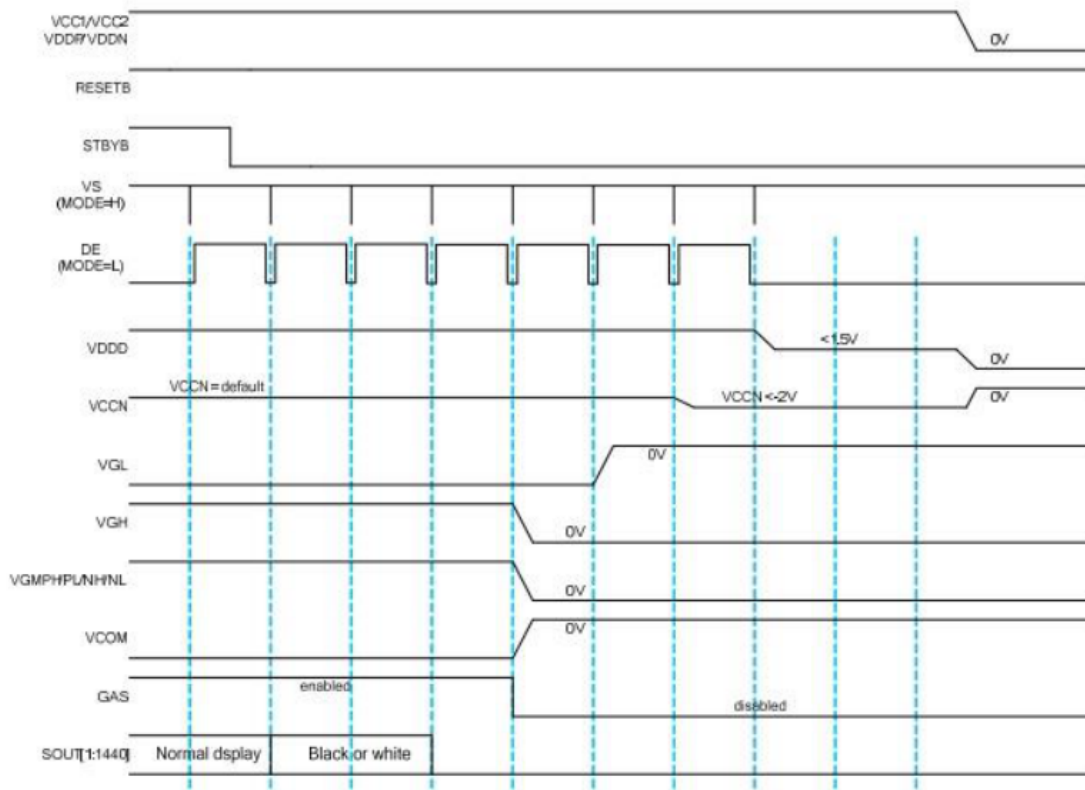

11. Quality Assurance

11.1.Purpose

This standard for Quality Assurance assures the quality of LCD module products supplied to customer.

11.2.Standard for Quality Test

11.2.1. Sampling Plan:

GB2828.1-2012

Single sampling, general inspection level II

11.2.2. Sampling Criteria:

Visual inspection: AQL 1.5

Electrical functional: AQL 0.65.

11.2.3. Reliability Test:

Detailed requirement refer to Reliability Test Specification.

11.3.Nonconforming Analysis & Disposition

11.3.1. Nonconforming analysis:

11.3.1.1. Customer should provide overall information of non-conforming sample for their complaints.

11.3.1.2. After receipt of detailed information from customer, the analysis of nonconforming parts usually should be finished in one week.

11.3.1.3. If cannot finish the analysis on time, customer will be notified with the progress status.

11.3.2. Disposition of nonconforming:

11.3.2.1. Non-conforming product over PPM level will be replaced.

11.3.2.2. The cause of non-conformance will be analyzed. Corrective action will be discussed and implemented.

11.4.Agreement Items

Shall negotiate with customer if the following situation occurs:

11.4.1. There is any discrepancy in standard of quality assurance.

11.4.2. Additional requirement to be added in product specification.

11.4.3. Any other special problem.

11.5.Standard of the Product Visual Inspection

11.5.1. Appearance inspection:

11.5.1.1. The inspection must be under illumination about 1000 – 1500 lx, and the distance of view must be at 30cm ± 2cm.

11.5.1.2. The viewing angle should be 45° from the vertical line without reflection light or follows customer's viewing angle specifications.

11.5.1.3. Definition of area: A Zone: Active Area, B Zone: Viewing Area,

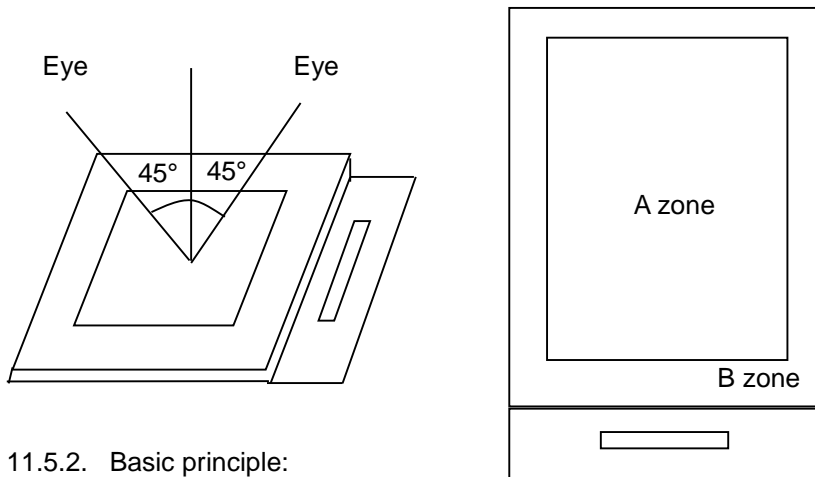

11.5.2. Basic principle:

11.5.2.1. A set of sample to indicate the limit of acceptable quality level must be discussed by both us and customer when there is any dispute happened.

11.5.2.2. New item must be added on time when it is necessary.

11.6. Inspection Specification

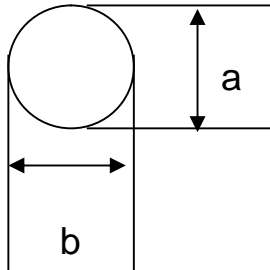
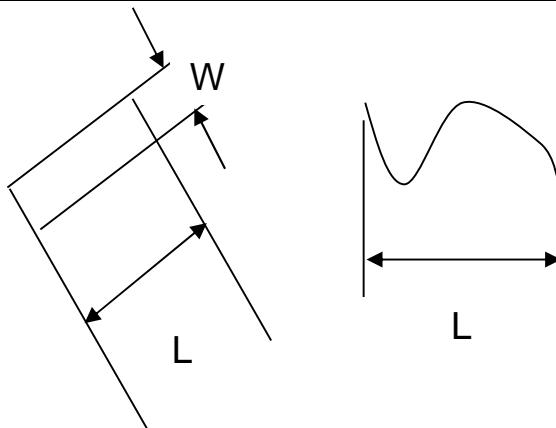
No.	Item	Criteria (Unit: mm)																		
01	Black / White Spot Foreign Material (Round Type) Pinholes Stain Particles Inside Cell. (Minor Defect)	 <table border="1" data-bbox="925 336 1436 560"> <thead> <tr> <th>Size</th> <th>Area</th> <th>Acc. Qty</th> </tr> </thead> <tbody> <tr> <td>$\phi \leq 0.20$</td> <td></td> <td>Ignore</td> </tr> <tr> <td>$0.20 < \phi \leq 0.50$</td> <td></td> <td>$N \leq 3$</td> </tr> <tr> <td>$0.50 < \phi$</td> <td></td> <td>0</td> </tr> </tbody> </table> <p>$\phi = (a + b) / 2$ Distance between 2 defects should more than 5mm apart.</p>	Size	Area	Acc. Qty	$\phi \leq 0.20$		Ignore	$0.20 < \phi \leq 0.50$		$N \leq 3$	$0.50 < \phi$		0						
Size	Area	Acc. Qty																		
$\phi \leq 0.20$		Ignore																		
$0.20 < \phi \leq 0.50$		$N \leq 3$																		
$0.50 < \phi$		0																		
02	Electrical Defect (Minor Defect)	<table border="1" data-bbox="598 761 1468 974"> <thead> <tr> <th>Bright Dot</th> <th>Display Area</th> <th>Total</th> <th rowspan="3">Note1</th> </tr> </thead> <tbody> <tr> <td></td> <td>$N \leq 2$</td> <td>$N \leq 2$</td> </tr> <tr> <td>Dark Dot</td> <td>$N \leq 4$</td> <td>$N \leq 4$</td> </tr> <tr> <td>Total Dot</td> <td>$N \leq 4$</td> <td>$N \leq 4$</td> <td></td> </tr> <tr> <td>Mura</td> <td colspan="2">Not visible through 5% ND filter.</td> <td>Note 2</td> </tr> </tbody> </table> <p>Remark: 1. Bright dot caused by scratch and foreign object accords to item 1.</p>	Bright Dot	Display Area	Total	Note1		$N \leq 2$	$N \leq 2$	Dark Dot	$N \leq 4$	$N \leq 4$	Total Dot	$N \leq 4$	$N \leq 4$		Mura	Not visible through 5% ND filter.		Note 2
Bright Dot	Display Area	Total	Note1																	
	$N \leq 2$	$N \leq 2$																		
Dark Dot	$N \leq 4$	$N \leq 4$																		
Total Dot	$N \leq 4$	$N \leq 4$																		
Mura	Not visible through 5% ND filter.		Note 2																	
03	Black and White Line Scratch Foreign Material (Line Type) (Minor Defect)	 <table border="1" data-bbox="654 1601 1284 1870"> <thead> <tr> <th>Length</th> <th>Width</th> <th>Acc. Qty</th> </tr> </thead> <tbody> <tr> <td>/</td> <td>$W \leq 0.1$</td> <td>Ignore</td> </tr> <tr> <td>$L \leq 2.5$</td> <td>$0.1 < W \leq 0.2$</td> <td>3</td> </tr> <tr> <td>$L > 2.5$</td> <td>$0.2 < W$</td> <td>0</td> </tr> <tr> <td colspan="2">Total</td> <td>3</td> </tr> </tbody> </table> <p>Distance between 2 defects should more than 3mm apart. Scratches not viewable through the back of the display are acceptable.</p>	Length	Width	Acc. Qty	/	$W \leq 0.1$	Ignore	$L \leq 2.5$	$0.1 < W \leq 0.2$	3	$L > 2.5$	$0.2 < W$	0	Total		3			
Length	Width	Acc. Qty																		
/	$W \leq 0.1$	Ignore																		
$L \leq 2.5$	$0.1 < W \leq 0.2$	3																		
$L > 2.5$	$0.2 < W$	0																		
Total		3																		

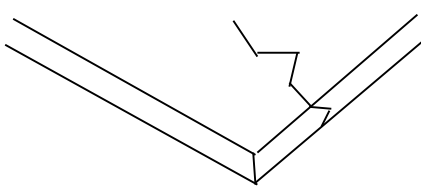
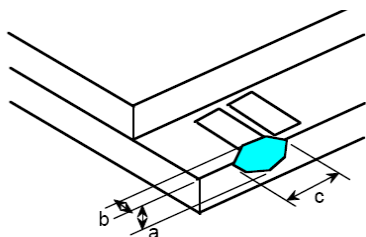
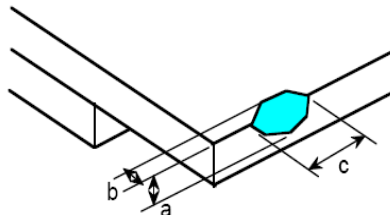
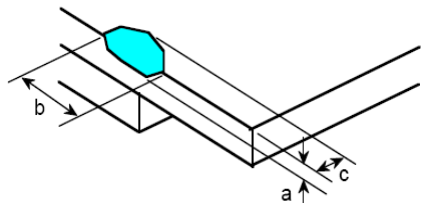
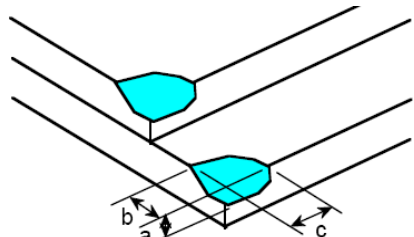
04	Glass Crack (Minor Defect)	 <p>Crack is potential to enlarge, any type is not allowed.</p>										
05	Glass Chipping Pad Area: (Minor Defect)	 <table border="1" data-bbox="906 638 1380 810"> <thead> <tr> <th>Length and Width</th> <th>Acc. Qty</th> </tr> </thead> <tbody> <tr> <td>$c > 3.0, b < 1.0$</td> <td>1</td> </tr> <tr> <td>$c < 3.0, b < 1.0$</td> <td>3</td> </tr> <tr> <td colspan="2">$a < \text{Glass Thickness}$</td> </tr> </tbody> </table>	Length and Width	Acc. Qty	$c > 3.0, b < 1.0$	1	$c < 3.0, b < 1.0$	3	$a < \text{Glass Thickness}$			
Length and Width	Acc. Qty											
$c > 3.0, b < 1.0$	1											
$c < 3.0, b < 1.0$	3											
$a < \text{Glass Thickness}$												
06	Glass Chipping Rear of Pad Area: (Minor Defect)	 <table border="1" data-bbox="906 1025 1380 1243"> <thead> <tr> <th>Length and Width</th> <th>Acc. Qty</th> </tr> </thead> <tbody> <tr> <td>$c > 3.0, b < 1.0$</td> <td>1</td> </tr> <tr> <td>$c < 3.0, b < 1.0$</td> <td>2</td> </tr> <tr> <td>$c < 3.0, b < 0.5$</td> <td>4</td> </tr> <tr> <td colspan="2">$a < \text{Glass Thickness}$</td> </tr> </tbody> </table>	Length and Width	Acc. Qty	$c > 3.0, b < 1.0$	1	$c < 3.0, b < 1.0$	2	$c < 3.0, b < 0.5$	4	$a < \text{Glass Thickness}$	
Length and Width	Acc. Qty											
$c > 3.0, b < 1.0$	1											
$c < 3.0, b < 1.0$	2											
$c < 3.0, b < 0.5$	4											
$a < \text{Glass Thickness}$												
07	Glass Chipping Except Pad Area: (Minor Defect)	 <table border="1" data-bbox="906 1400 1380 1617"> <thead> <tr> <th>Length and Width</th> <th>Acc. Qty</th> </tr> </thead> <tbody> <tr> <td>$c > 3.0, b < 1.0$</td> <td>1</td> </tr> <tr> <td>$c < 3.0, b < 1.0$</td> <td>2</td> </tr> <tr> <td>$c < 3.0, b < 0.5$</td> <td>4</td> </tr> <tr> <td colspan="2">$a < \text{Glass Thickness}$</td> </tr> </tbody> </table>	Length and Width	Acc. Qty	$c > 3.0, b < 1.0$	1	$c < 3.0, b < 1.0$	2	$c < 3.0, b < 0.5$	4	$a < \text{Glass Thickness}$	
Length and Width	Acc. Qty											
$c > 3.0, b < 1.0$	1											
$c < 3.0, b < 1.0$	2											
$c < 3.0, b < 0.5$	4											
$a < \text{Glass Thickness}$												
08	Glass Corner Chipping: (Minor Defect)	 <table border="1" data-bbox="906 1774 1380 1904"> <thead> <tr> <th>Length and Width</th> <th>Acc. Qty</th> </tr> </thead> <tbody> <tr> <td>$c < 3.0, b < 3.0$</td> <td>Ignore</td> </tr> <tr> <td colspan="2">$a < \text{Glass Thickness}$</td> </tr> </tbody> </table>	Length and Width	Acc. Qty	$c < 3.0, b < 3.0$	Ignore	$a < \text{Glass Thickness}$					
Length and Width	Acc. Qty											
$c < 3.0, b < 3.0$	Ignore											
$a < \text{Glass Thickness}$												

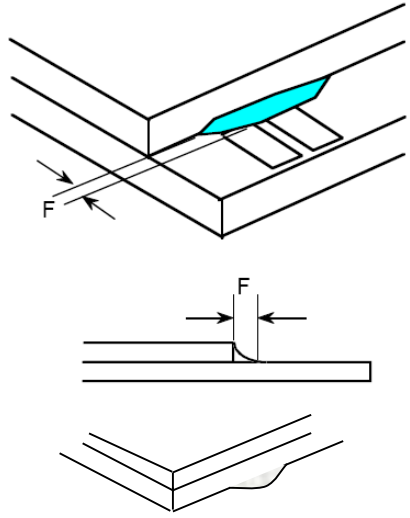
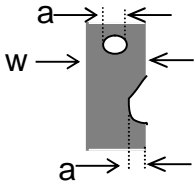
<p>09</p>	<p>Glass Burr: (Minor Defect)</p> 	<table border="1" data-bbox="906 264 1380 353"> <thead> <tr> <th>Length</th> <th>Acc. Qty</th> </tr> </thead> <tbody> <tr> <td>$F < 1.0$</td> <td>Ignore</td> </tr> </tbody> </table> <p>Glass burr don't affect assemble and module dimension.</p>	Length	Acc. Qty	$F < 1.0$	Ignore				
Length	Acc. Qty									
$F < 1.0$	Ignore									
<p>10</p>	<p>FPC Defect: (Minor Defect)</p> 	<p>10.1 Dent, pinhole width $a < w/3$. (w: circuitry width.) 10.2 Open circuit is unacceptable. 10.3 No oxidation, contamination and distortion.</p>								
<p>11</p>	<p>Bubble on Polarizer (Minor Defect)</p>	<table border="1" data-bbox="782 1299 1252 1473"> <thead> <tr> <th>Diameter</th> <th>Acc. Qty</th> </tr> </thead> <tbody> <tr> <td>$\varphi \leq 0.30$</td> <td>Ignore</td> </tr> <tr> <td>$0.30 < \varphi \leq 0.50$</td> <td>$N \leq 2$</td> </tr> <tr> <td>$0.50 < \varphi$</td> <td>$N = 0$</td> </tr> </tbody> </table>	Diameter	Acc. Qty	$\varphi \leq 0.30$	Ignore	$0.30 < \varphi \leq 0.50$	$N \leq 2$	$0.50 < \varphi$	$N = 0$
Diameter	Acc. Qty									
$\varphi \leq 0.30$	Ignore									
$0.30 < \varphi \leq 0.50$	$N \leq 2$									
$0.50 < \varphi$	$N = 0$									
<p>12</p>	<p>Dent on Polarizer (Minor Defect)</p>	<table border="1" data-bbox="782 1541 1252 1715"> <thead> <tr> <th>Diameter</th> <th>Acc. Qty</th> </tr> </thead> <tbody> <tr> <td>$\varphi \leq 0.25$</td> <td>Ignore</td> </tr> <tr> <td>$0.25 < \varphi \leq 0.50$</td> <td>$N \leq 4$</td> </tr> <tr> <td>$0.50 < \varphi$</td> <td>None</td> </tr> </tbody> </table>	Diameter	Acc. Qty	$\varphi \leq 0.25$	Ignore	$0.25 < \varphi \leq 0.50$	$N \leq 4$	$0.50 < \varphi$	None
Diameter	Acc. Qty									
$\varphi \leq 0.25$	Ignore									
$0.25 < \varphi \leq 0.50$	$N \leq 4$									
$0.50 < \varphi$	None									
<p>13</p>	<p>Bezel</p>	<p>13.1 No rust, distortion on the Bezel. 13.2 No visible fingerprints, stains or other contamination.</p>								
<p>14</p>	<p>PCB</p>	<p>14.1 No distortion or contamination on PCB terminals. 14.2 All components on PCB must same as documented on the BOM/component layout. 14.3 Follow IPC-A-600F.</p>								

15	Soldering	Follow IPC-A-610C standard
16	Electrical Defect (Major defect)	The below defects must be rejected. 16.1 Missing vertical / horizontal segment, 16.2 Abnormal Display. 16.3 No function or no display. 16.4 Current exceeds product specifications. 16.5 LCD viewing angle defect. 16.6 No Backlight. 16.7 Dark Backlight. 16.8 Touch Panel no function.

Remark: LCD Panel Broken shall be rejected. Defect out of LCD viewing area is acceptable.

11.7. Classification of Defects

- 11.7.1. Visual defects (Except no / wrong label) are treated as minor defect and electrical defect is major.
- 11.7.2. Two minor defects are equal to one major in lot sampling inspection.

11.8. Identification/marketing criteria

Any unit with illegible / wrong /double or no marking/ label shall be rejected.

11.9. Packing

- 11.9.1. There should be no damage of the outside carton box, each packaging box should have one identical label.
- 11.9.2. Modules inside package box should have compliant mark.
- 11.9.3. All direct package materials shall offer ESD protection.

Note1: Bright dot is defined as the defective area of the dot is larger than 50% of one sub-pixel area.

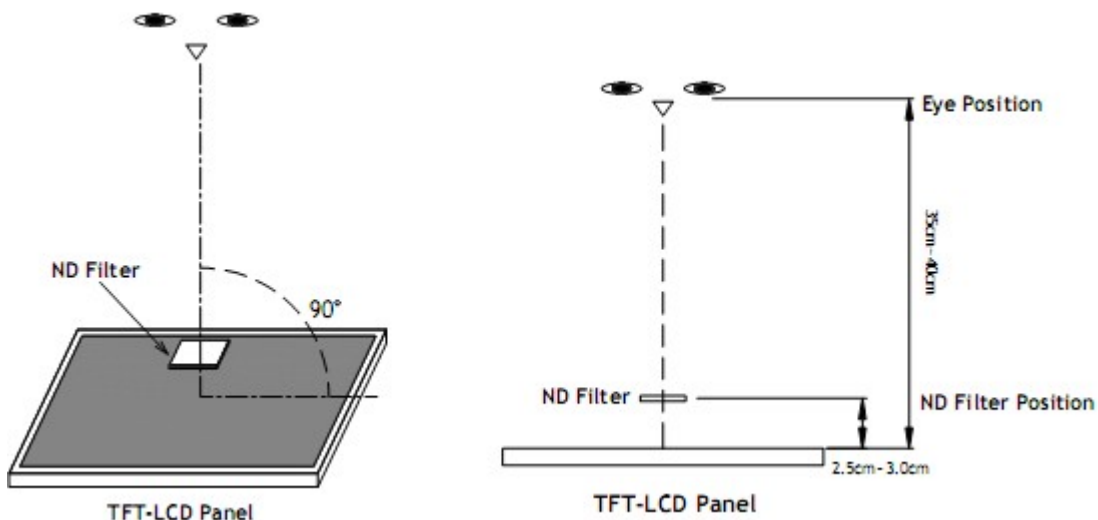

Bright dot: The bright dot size defect at black display pattern. It can be recognized by 2% transparency of filter when the distance between eyes and panel is 350mm ± 50mm.

Dark dot: Cyan, Magenta or Yellow dot size defect at white display pattern. It can be recognized by 5%

transparency of filter when the distance between eyes and panel is 350mm± 50mm.

Note2: Mura on display which appears darker / brighter against background brightness on parts of display area.

12. Reliability Specification

No	Item	Condition	Quantity	Criteria
1	High Temperature Operating	85°C, 240Hrs	2	GB/T2423.2-2008
2	Low Temperature Operating	-30°C,240Hrs	2	GB/T2423.1-2008
3	High Humidity	65°C, 90%RH, 240Hrs	2	GB/T2423.3-2016
4	High Temperature Storage	90°C, 240Hrs	2	GB/T2423.2-2008
5	Low Temperature Storage	-40°C, 240Hrs	2	GB/T2423.1-2008
6	Thermal Cycling Test	-30°C, 60min~85°C, 30min, 100 cycles.	2	GB/T2423.22-2012
7	Packing Vibration	Frequency range:10Hz~50Hz Acceleration of gravity:5G X,Y,Z 30 min for each direction.	2	GB/T5170.14-2009
8	Electrical Static Discharge	Air: ± 15kV 150pF/330Ω 5 times Contact: ± 8kV 150pF/330Ω 5 times	2	GB/T17626.2-2018
9	Drop Test (Packaged)	Height:80 cm,1 corner, 3 edges, 6 surfaces.	2	GB/T2423.8-1995

Note1. No deflection cosmetic and operational function allowable.

Note2. Total current Consumption should be below double of initial value

13. Precautions and Warranty

13.1. Safety

- 13.1.1. The liquid crystal in the LCD is poisonous. Do not put it in your mouth. If the liquid crystal touches your skin or clothes, wash it off immediately using soap and water.
- 13.1.2. Since the liquid crystal cells are made of glass, do not apply strong impact on them. Handle with care.

13.2. Handling

- 13.2.1. Reverse and use within ratings in order to keep performance and prevent damage.
- 13.2.2. Do not wipe the polarizer with dry cloth, as it might cause scratch. If the surface of the LCD needs to be cleaned, wipe it swiftly with cotton or other soft cloth soaked with petroleum IPA, do not use other chemicals.

13.3. Storage

- 13.3.1. Do not store the LCD module beyond the specified temperature ranges.
- 13.3.2. Strong light exposure causes degradation of polarizer and color filter.

13.4. Metal Pin (Apply to Products with Metal Pins)

13.4.1. Pins of LCD and Backlight

13.4.1.1. Solder tip can touch and press on the tip of Pin LEAD during the soldering

13.4.1.2. Recommended Soldering Conditions

Solder Type: Sn96.3~94-Ag3.3~4.3-Cu0.4~1.1

Maximum Solder Temperature: 370°C

Maximum Solder Time: 3s at the maximum temperature

Recommended Soldering Temp: 350±20°C

Typical Soldering Time: ≤3s

13.4.1.3. Solder Wetting

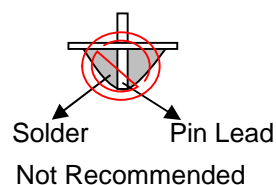
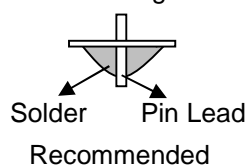

13.4.2. Pins of EL

13.4.2.1. Solder tip can touch and press on the tip of EL leads during soldering.

13.4.2.2. No Solder Paste on the soldering pad on the motherboard is recommended.

13.4.2.3. Recommended Soldering Conditions

Solder type: Nippon Alimit Leadfree SR-34, size 0.5mm

Recommended Solder Temperature: 270~290°C

Typical Soldering Time: ≤2s

Minimum solder distance from EL lamp (body):2.0mm

13.4.2.4. No horizontal press on the EL leads during soldering.

13.4.2.5. 180° bend EL leads three times is not allowed.

13.4.2.6. Solder Wetting

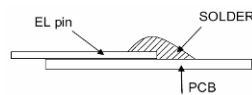

Recommended

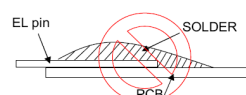

Not Recommended

13.4.2.7. The type of the solder iron:

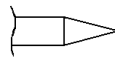

Recommended

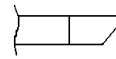

Not Recommended

13.4.2.8. Solder Pad

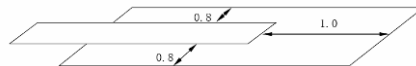

13.5.Operation

- 13.5.1. Do not drive LCD with DC voltage
- 13.5.2. Response time will increase below lower temperature
- 13.5.3. Display may change color with different temperature
- 13.5.4. Mechanical disturbance during operation, such as pressing on the display area, may cause the segments to appear “fractured”.
- 13.5.5. Do not connect or disconnect the LCM to or from the system when power is on.
- 13.5.6. Never use the LCM under abnormal condition of high temperature and high humidity.
- 13.5.7. Module has high frequency circuits. Sufficient suppression to the electromagnetic interface shall be done by system manufacturers. Grounding and shielding methods may be important to minimize the interference.
- 13.5.8. Do not display the fixed pattern for long time (we suggest the time not longer than one hour) because it may develop image sticking due to the TFT structure.

13.6.Static Electricity

- 13.6.1. CMOS LSIs are equipped in this unit, so care must be taken to avoid the electro-static charge, by ground human body, etc.
- 13.6.2. The normal static prevention measures should be observed for work clothes and benches.
- 13.6.3. The module should be kept into anti-static bags or other containers resistant to static for storage.

13.7.Limited Warranty

- 13.7.1. Our warranty liability is limited to repair and/or replacement. We will not be responsible for any consequential loss.
- 13.7.2. If possible, we suggest customer to use up all modules in six months. If the module storage time over twelve months, we suggest that recheck it before the module be used.
- 13.7.3. After the product shipped, any product quality issues must be feedback within three months, otherwise, we will not be responsible for the subsequent or consequential events.

14. Outline Drawing

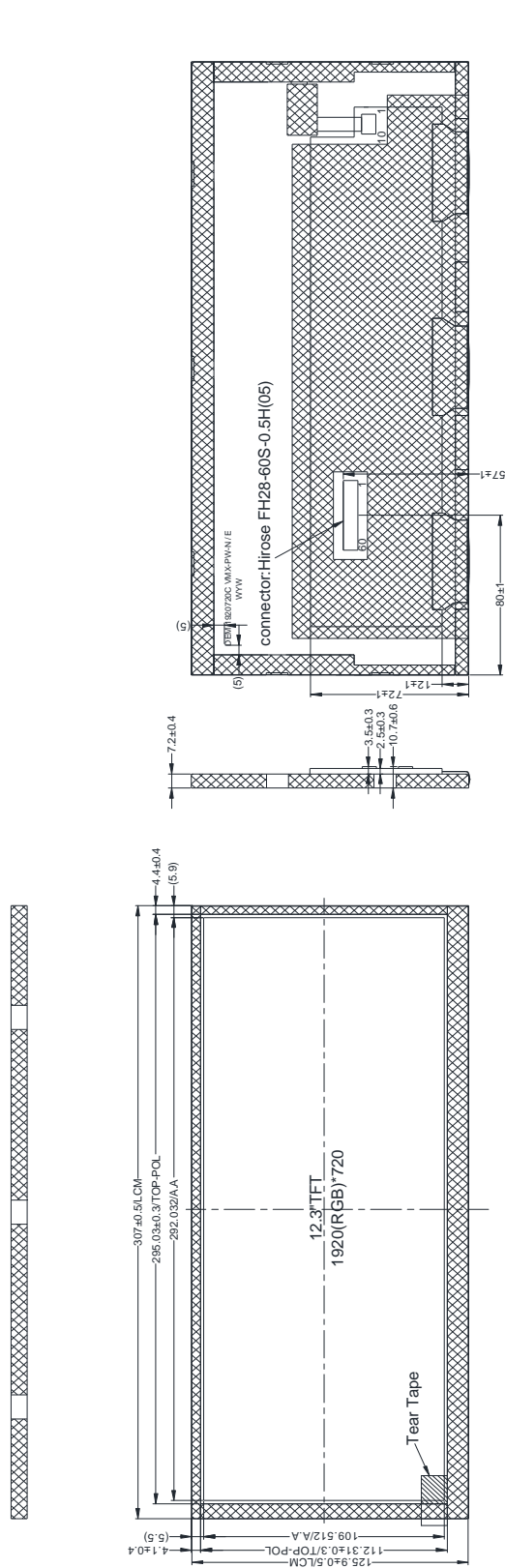

NO.	PIN NAME	NO.	PIN NAME	NO.	PIN NAME	NO.	PIN NAME
1	GND	16	GND	31	GND	46	TB
2	VCC	17	ORXIN3-	32	ERXIN3-	47	FAULT
3	VCC	18	ORXIN3+	33	ERXIN3+	48	NC
4	GND	19	GND	34	GND	49	LEDA
5	ORXIN0-	20	ERXIN0-	35	NC	50	LEDA
6	ORXIN0+	21	ERXIN0+	36	RESET	51	NC
7	GND	22	GND	37	STBYB	52	NC
8	ORXIN1-	23	ERXIN1-	38	SOL	53	LEDK1
9	ORXIN1+	24	ERXIN1+	39	SDA	54	LEDK2
10	GND	25	GND	40	CSB	55	LEDK3
11	ORXIN2-	26	ERXIN2-	41	ATREN	56	LEDK4
12	ORXIN2+	27	ERXIN2+	42	NC	57	NC
13	GND	28	GND	43	VOTP	58	NTC_A
14	ORXCLKIN-	29	ERXCLKIN-	44	GND	59	NC
15	ORXCLKIN+	30	ERXCLKIN+	45	LR	60	NTC_K



NOTES:

1. Display size: 12.3" TFT
2. Viewing direction: Full View
3. Display mode: Transmissive/Normal black
4. Operation temperature: -30°C~+85°C
5. Storage temperature: -40°C~+90°C
6. Power supply voltage: 3.3V
7. Backlight :White(36 LED)/27.9V(TYP) /400mA
8. Luminance: 1000cd/m²(TYP)
9. ROHS must be complied

* Unspecification tolerance are ± 0.3mm
 *The dimension with mark brackets "()" just for reference