

XPC 1,5/ 3-ST-3,5 BK - PCB connector



1464105

<https://www.phoenixcontact.com/sk/products/1464105>

Please be informed that the data shown in this PDF document is generated from our online catalog. Please find the complete data in the user documentation. Our general terms of use for downloads are valid.



PCB connector, nominal cross section: 1.5 mm², color: black, nominal current: 8 A, rated voltage (III/2): 160 V, contact surface: Sn, contact connection type: Socket, number of rows: 1, number of positions: 3, product range: XPC 1,5/-ST, pitch: 3.5 mm, connection method: Push-X-connection, conductor/PCB connection direction: 0 °, locking clip: - without locking clip, plug-in system: COMBICON MC 1,5, locking: without, mounting: without, type of packaging: packed in cardboard

Your advantages

- Highly convenient operation thanks to direct, effortless, and tool-free conductor connection
- Quick connection of all conductor types with and even without ferrules
- Reliable wiring thanks to acoustic and visual feedback
- Quick conductor release by simply pressing the orange release button
- Plug-in compatibility with existing headers of the COMBICON portfolio
- Quick and convenient testing using integrated test option

Commercial data

Item number	1464105
Packing unit	100 pc
Minimum order quantity	100 pc
Note	Made to order (non-returnable)
Sales key	AAB
Product key	AABGAA
GTIN	4063151855697
Weight per piece (including packing)	3.55 g
Weight per piece (excluding packing)	3.191 g
Customs tariff number	85366990
Country of origin	DE

XPC 1,5/ 3-ST-3,5 BK - PCB connector



1464105

<https://www.phoenixcontact.com/sk/products/1464105>

Technical data

Product properties

Product type	PCB connector
Product family	XPC 1,5/...-ST
Product line	COMBICON Connectors S
Number of positions	3
Pitch	3.5 mm
Number of rows	1

Data management status

Article revision	05
------------------	----

Electrical properties

Nominal current I_N	8 A
Nominal voltage U_N	160 V
Contact resistance	2.2 m Ω
Rated voltage (III/3)	160 V
Rated surge voltage (III/3)	2.5 kV
Rated voltage (III/2)	160 V
Rated surge voltage (III/2)	2.5 kV
Rated voltage (II/2)	320 V
Rated surge voltage (II/2)	2.5 kV

Connection data

Connection technology

Connector system	COMBICON MC 1,5
Nominal cross section	1.5 mm ²
Contact connection type	Socket

Interlock

Locking type	without
Mounting flange	without

Conductor connection

Connection method	Push-X-connection
Conductor/PCB connection direction	0 °
Conductor cross section rigid	0.34 mm ² ... 1.5 mm ²
Conductor cross section flexible	0.5 mm ² ... 1.5 mm ²
Conductor cross section AWG	20 ... 16
Conductor cross section flexible, with ferrule without plastic sleeve	0.5 mm ² ... 1.5 mm ²
Conductor cross section, flexible, with ferrule, with plastic sleeve	0.25 mm ² ... 0.75 mm ²
Cylindrical gauge a x b / diameter	2.4 mm x 1.5 mm / -
Stripping length	10 mm

XPC 1,5/ 3-ST-3,5 BK - PCB connector



1464105

<https://www.phoenixcontact.com/sk/products/1464105>

Specifications for ferrules without insulating collar

recommended crimping tool	1212034 CRIMPFOX 6
	1213144 CRIMPFOX CENTRUS 6S
ferrules without insulating collar, according to DIN 46228-1	Cross section: 0.5 mm ² ; Length: 8 mm ... 10 mm
	Cross section: 0.75 mm ² ; Length: 8 mm ... 10 mm
	Cross section: 1 mm ² ; Length: 8 mm ... 10 mm
	Cross section: 1.5 mm ² ; Length: 10 mm

Specifications for ferrules with insulating collar

recommended crimping tool	1212034 CRIMPFOX 6
	1213144 CRIMPFOX CENTRUS 6S
ferrules with insulating collar, according to DIN 46228-4	Cross section: 0.25 mm ² ; Length: 8 mm
	Cross section: 0.34 mm ² ; Length: 8 mm ... 10 mm
	Cross section: 0.5 mm ² ; Length: 8 mm ... 10 mm
	Cross section: 0.75 mm ² ; Length: 10 mm

Material specifications

Material data - contact

Note	WEEE/RoHS-compliant, free of whiskers according to IEC 60068-2-82/JEDEC JESD 201
Contact material	Cu alloy
Surface characteristics	hot-dip tin-plated
Metal surface terminal point (top layer)	Tin (4 - 8 µm Sn)
Metal surface contact area (top layer)	Tin (4 - 8 µm Sn)

Material data - housing

Color (Housing)	black (9005)
Insulating material	PA
Insulating material group	I
CTI according to IEC 60112	600
Flammability rating according to UL 94	V0
Glow wire flammability index GWFI according to EN 60695-2-12	850
Glow wire ignition temperature GWIT according to EN 60695-2-13	775
Temperature for the ball pressure test according to EN 60695-10-2	300 °C

Material data – actuating element

Color (Actuating element)	orange (2003)
Insulating material	PBT
Insulating material group	I
CTI according to IEC 60112	600
Flammability rating according to UL 94	V0

Dimensions

XPC 1,5/ 3-ST-3,5 BK - PCB connector



1464105

<https://www.phoenixcontact.com/sk/products/1464105>

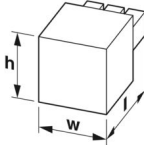
Dimensional drawing	
Pitch	3.5 mm
Width [w]	12.13 mm
Height [h]	12.46 mm
Length [l]	25.95 mm

Notes

Notes on operation	In accordance with IEC 61984, COMBICON connectors have no switching power (COC). During designated use, they must not be plugged in or disconnected when carrying voltage or under load.
--------------------	--

Mechanical tests

Conductor connection

Specification	IEC 60999-1:1999-11
Result	Test passed

Test for conductor damage and slackening

Specification	IEC 60999-1:1999-11
Result	Test passed

Repeated connection and disconnection

Specification	IEC 60999-1:1999-11
Result	Test passed

Pull-out test

Specification	IEC 60999-1:1999-11
Conductor cross section/conductor type/tractive force setpoint/actual value	0.34 mm ² / solid / > 15 N
	0.5 mm ² / flexible / > 20 N
	1.5 mm ² / solid / > 40 N
	1.5 mm ² / flexible / > 40 N

Insertion and withdrawal forces

Specification	IEC 60512-13-2:2006-02
Result	Test passed
No. of cycles	25
Insertion strength per pos. approx.	8 N
Withdraw strength per pos. approx.	5 N

Resistance of inscriptions

Specification	IEC 60068-2-70:1995-12
Result	Test passed

XPC 1,5/ 3-ST-3,5 BK - PCB connector



1464105

<https://www.phoenixcontact.com/sk/products/1464105>

Polarization and coding

Specification	IEC 60512-13-5:2006-02
Result	Test passed

Visual inspection

Specification	IEC 60512-1-1:2002-02
Result	Test passed

Dimension check

Specification	IEC 60512-1-2:2002-02
Result	Test passed

Environmental and real-life conditions

Vibration test

Specification	IEC 60068-2-6:2007-12
Frequency	10 - 150 - 10 Hz
Sweep speed	1 octave/min
Amplitude	0.35 mm (10 Hz ... 60.1 Hz)
Acceleration	50 m/s ² (60.1 Hz ... 150 Hz)
Test duration per axis	2.5 h
Test directions	X-, Y- and Z-axis

Durability test

Specification	IEC 60512-9-1:2010-03
Impulse withstand voltage at sea level	2.95 kV
Contact resistance R ₁	2.2 mΩ
Contact resistance R ₂	2.1 mΩ
Insertion/withdrawal cycles	25
Insulation resistance, neighboring positions	> 5 MΩ

Climatic test

Specification	ISO 22479:2019-05
Corrosive stress	0.2 dm ³ SO ₂ on 300 dm ³ /40 °C/1 cycle
Thermal stress	105 °C/168 h
Power-frequency withstand voltage	1.39 kV

Ambient conditions

Ambient temperature (operation)	-40 °C ... 105 °C (dependent on the derating curve)
Ambient temperature (storage/transport)	-40 °C ... 70 °C
Relative humidity (storage/transport)	30 % ... 70 %
Ambient temperature (assembly)	-5 °C ... 100 °C

Electrical tests

Thermal test | Test group C

Specification	IEC 60512-5-1:2002-02
---------------	-----------------------

XPC 1,5/ 3-ST-3,5 BK - PCB connector



1464105

<https://www.phoenixcontact.com/sk/products/1464105>

Tested number of positions	16
----------------------------	----

Insulation resistance

Specification	IEC 60512-3-1:2002-02
Insulation resistance, neighboring positions	> 5 MΩ

Air clearances and creepage distances |

Specification	IEC 60664-1:2007-04
Insulating material group	I
Comparative tracking index (IEC 60112)	CTI 600
Rated insulation voltage (III/3)	160 V
Rated surge voltage (III/3)	2.5 kV
minimum clearance value - non-homogenous field (III/3)	1.5 mm
minimum creepage distance (III/3)	2 mm
Rated insulation voltage (III/2)	160 V
Rated surge voltage (III/2)	2.5 kV
minimum clearance value - non-homogenous field (III/2)	1.5 mm
minimum creepage distance (III/2)	1.5 mm
Rated insulation voltage (II/2)	320 V
Rated surge voltage (II/2)	2.5 kV
minimum clearance value - non-homogenous field (II/2)	1.5 mm
minimum creepage distance (II/2)	1.6 mm

Packaging specifications

Type of packaging	packed in cardboard
-------------------	---------------------

XPC 1,5/ 3-ST-3,5 BK - PCB connector



1464105

<https://www.phoenixcontact.com/sk/products/1464105>

Drawings

Diagram

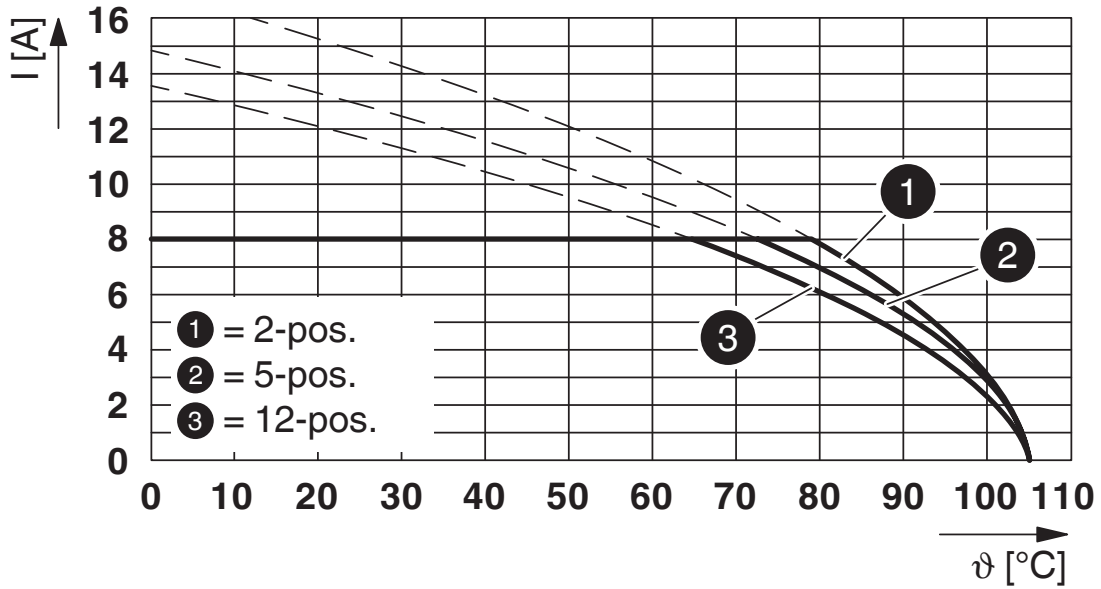

Type: XPC 1,5/...-ST-3,5 with IFMC 1,5/...-ST-3,5

Diagram

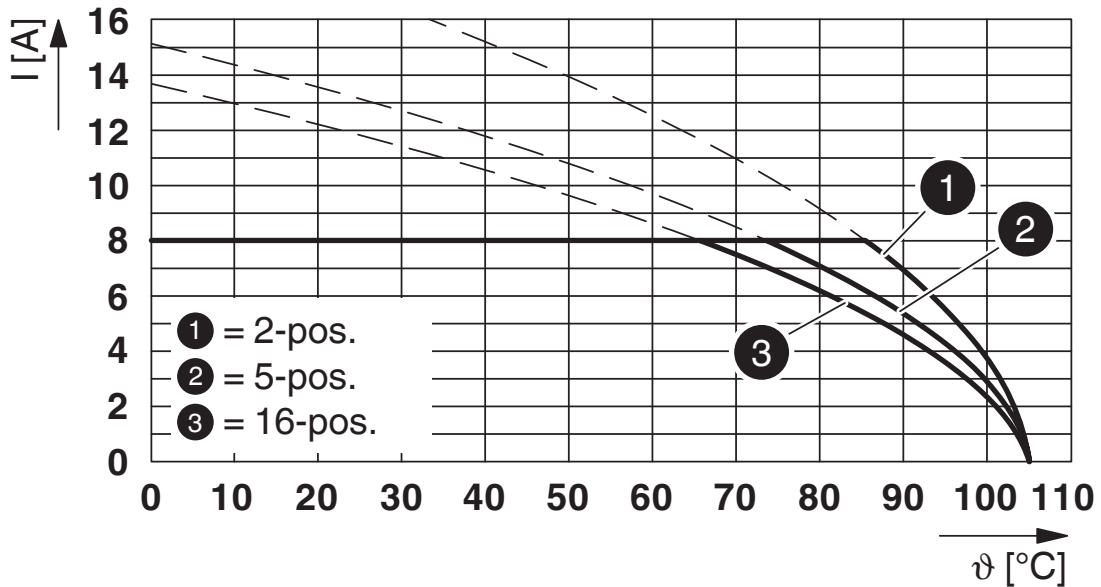

Type: XPC 1,5/...-ST-3,5 with MC 1,5/...-G-3,5 P... THR

XPC 1,5/ 3-ST-3,5 BK - PCB connector

1464105

<https://www.phoenixcontact.com/sk/products/1464105>

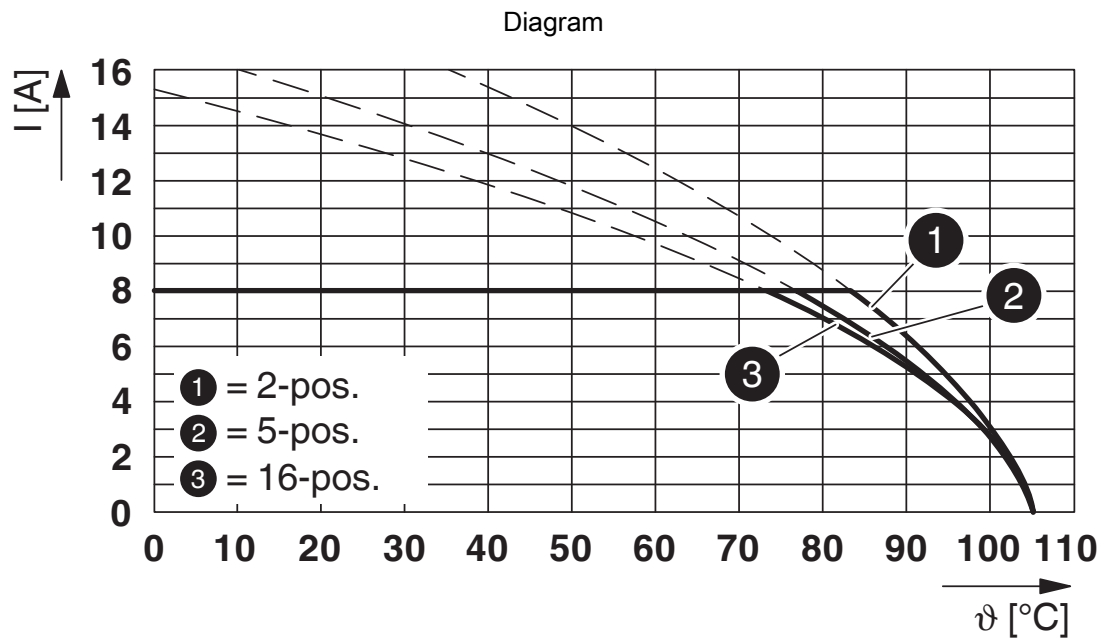

Type: XPC 1,5/...-ST-3,5 with MCV 1,5/...-G-3,5

XPC 1,5/ 3-ST-3,5 BK - PCB connector





1464105

<https://www.phoenixcontact.com/sk/products/1464105>

Approvals

To download certificates, visit the product detail page: <https://www.phoenixcontact.com/sk/products/1464105>

 VDE Zeichengenehmigung Approval ID: 40057836				
	Nominal voltage U_N	Nominal current I_N	Cross section AWG	Cross section mm^2
Only flexible conductors	160 V	8 A	-	0.5 - 1.5
Only rigid conductors	160 V	8 A	-	0.34 - 1.5

 UL Recognized Approval ID: E60425-20230810				
	Nominal voltage U_N	Nominal current I_N	Cross section AWG	Cross section mm^2
Use group F				
Only flexible conductors	160 V	8 A	20 - 16	-
Only rigid conductors	160 V	8 A	22 - 16	-

 cULus Recognized Approval ID: E60425-20230810				
	Nominal voltage U_N	Nominal current I_N	Cross section AWG	Cross section mm^2
Use group B				
Only flexible conductors	150 V	8 A	20 - 16	-
Only rigid conductors	150 V	8 A	22 - 16	-
Use group D				
Only flexible conductors	300 V	8 A	20 - 16	-
Only rigid conductors	300 V	8 A	22 - 16	-

XPC 1,5/ 3-ST-3,5 BK - PCB connector



1464105

<https://www.phoenixcontact.com/sk/products/1464105>

Classifications

ECLASS

ECLASS-11.0	27460202
ECLASS-13.0	27460202
ECLASS-12.0	27460202

ETIM

ETIM 9.0	EC002638
----------	----------

XPC 1,5/ 3-ST-3,5 BK - PCB connector



1464105

<https://www.phoenixcontact.com/sk/products/1464105>

Environmental product compliance

EU RoHS

Fulfills EU RoHS substance requirements	Yes, No exemptions
---	--------------------

China RoHS

Environment friendly use period (EFUP)	EFUP-E
	No hazardous substances above the limits

EU REACH SVHC

REACH candidate substance (CAS No.)	No substance above 0.1 wt%
-------------------------------------	----------------------------

EF3.0 Climate Change

CO2e kg	0.144 kg CO2e
---------	---------------

XPC 1,5/ 3-ST-3,5 BK - PCB connector

1464105

<https://www.phoenixcontact.com/sk/products/1464105>

Accessories

SZS 0,4X2,5 VDE - Screwdriver

1205037

<https://www.phoenixcontact.com/sk/products/1205037>



Screwdriver, slot-headed, VDE insulated, size: 0.4 x 2.5 x 80 mm, 2-component grip, with non-slip grip

CRIMPFOX 6 - Crimping pliers

1212034

<https://www.phoenixcontact.com/sk/products/1212034>



Crimping pliers, for ferrules without insulating collar according to DIN 46228 Part 1 and ferrules with insulating collar according to DIN 46228 Part 4, 0.25 mm² ... 6.0 mm², lateral entry, trapezoidal crimp

XPC 1,5/ 3-ST-3,5 BK - PCB connector

1464105

<https://www.phoenixcontact.com/sk/products/1464105>



CRIMPFOX CENTRUS 6S - Crimping pliers

1213144

<https://www.phoenixcontact.com/sk/products/1213144>



Crimping pliers, for uninsulated and insulated ferrules, DIN 46228 Part 1 and 4, from 0.14 mm² ... 6 mm², also for TWIN ferrules up to 2 x 4 mm², automatic cross section adjustment, lateral insertion, equipped with fall protection

MPS-MT 1-S - Test plug

1944372

<https://www.phoenixcontact.com/sk/products/1944372>

Test plug, consisting of 1.0 mm Ø test pin and 2.0 mm Ø socket



XPC 1,5/ 3-ST-3,5 BK - PCB connector

1464105

<https://www.phoenixcontact.com/sk/products/1464105>



IFMC 1,5/ 3-ST-3,5 - PCB connector

1843993

<https://www.phoenixcontact.com/sk/products/1843993>



PCB connector, nominal cross section: 1.5 mm², color: green, nominal current: 8 A, rated voltage (III/2): 160 V, contact surface: Sn, contact connection type: Pin, number of potentials: 3, number of rows: 1, number of positions: 3, number of connections: 3, product range: IFMC 1,5/...-ST, pitch: 3.5 mm, connection method: Push-in spring connection, conductor/PCB connection direction: 0 °, plug-in system: COMBICON MC 1,5, locking: without, mounting: without, type of packaging: packed in cardboard

MCV 1,5/ 3-G-3,5 P20 THRR32 - PCB header

1780901

<https://www.phoenixcontact.com/sk/products/1780901>

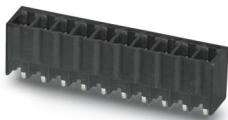

PCB headers, nominal cross section: 1.5 mm², color: black, nominal current: 8 A, rated voltage (III/2): 160 V, contact surface: Sn, contact connection type: Pin, number of potentials: 3, number of rows: 1, number of positions: 3, number of connections: 3, product range: MCV 1,5/...-G-THR, pitch: 3.5 mm, mounting: THR soldering / wave soldering, pin layout: Linear pinning, solder pin [P]: 2 mm, number of solder pins per potential: 1, plug-in system: COMBICON MC 1,5, Pin connector pattern alignment: Standard, locking: without, mounting: without, type of packaging: 32 mm wide tape, For user information and design recommendations for through-hole reflow technology, go to: Downloads

XPC 1,5/ 3-ST-3,5 BK - PCB connector

1464105

<https://www.phoenixcontact.com/sk/products/1464105>

MC 1,5/ 3-G-3,5 P26 THR - PCB header

1788521

<https://www.phoenixcontact.com/sk/products/1788521>

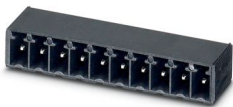

PCB headers, nominal cross section: 1.5 mm², color: black, nominal current: 8 A, rated voltage (III/2): 160 V, contact surface: Sn, contact connection type: Pin, number of potentials: 3, number of rows: 1, number of positions: 3, number of connections: 3, product range: MC 1,5/..-G-THR, pitch: 3.5 mm, mounting: THR soldering / wave soldering, pin layout: Linear pinning, solder pin [P]: 2.6 mm, number of solder pins per potential: 1, plug-in system: COMBICON MC 1,5, Pin connector pattern alignment: Standard, locking: without, mounting: without, type of packaging: packed in cardboard

MC 1,5/ 3-G-3,5 P26 THRR32 - PCB header

1788534

<https://www.phoenixcontact.com/sk/products/1788534>

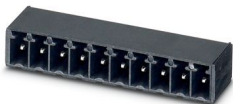

PCB headers, nominal cross section: 1.5 mm², color: black, nominal current: 8 A, rated voltage (III/2): 160 V, contact surface: Sn, contact connection type: Pin, number of potentials: 3, number of rows: 1, number of positions: 3, number of connections: 3, product range: MC 1,5/..-G-THR, pitch: 3.5 mm, mounting: THR soldering / wave soldering, pin layout: Linear pinning, solder pin [P]: 2.6 mm, number of solder pins per potential: 1, plug-in system: COMBICON MC 1,5, Pin connector pattern alignment: Standard, locking: without, mounting: without, type of packaging: 32 mm wide tape

XPC 1,5/ 3-ST-3,5 BK - PCB connector

1464105

<https://www.phoenixcontact.com/sk/products/1464105>

MC 1,5/ 3-G-3,5 P20 THRR32 - PCB header

1788754

<https://www.phoenixcontact.com/sk/products/1788754>



PCB headers, nominal cross section: 1.5 mm², color: black, nominal current: 8 A, rated voltage (III/2): 160 V, contact surface: Sn, contact connection type: Pin, number of potentials: 3, number of rows: 1, number of positions: 3, number of connections: 3, product range: MC 1,5/..-G-THR, pitch: 3.5 mm, mounting: THR soldering / wave soldering, pin layout: Linear pinning, solder pin [P]: 2 mm, number of solder pins per potential: 1, plug-in system: COMBICON MC 1,5, Pin connector pattern alignment: Standard, locking: without, mounting: without, type of packaging: 32 mm wide tape

MC 1,5/ 3-G-3,5 P14 THR - PCB header

1788961

<https://www.phoenixcontact.com/sk/products/1788961>



PCB headers, nominal cross section: 1.5 mm², color: black, nominal current: 8 A, rated voltage (III/2): 160 V, contact surface: Sn, contact connection type: Pin, number of potentials: 3, number of rows: 1, number of positions: 3, number of connections: 3, product range: MC 1,5/..-G-THR, pitch: 3.5 mm, mounting: THR soldering / wave soldering, pin layout: Linear pinning, solder pin [P]: 1.4 mm, number of solder pins per potential: 1, plug-in system: COMBICON MC 1,5, Pin connector pattern alignment: Standard, locking: without, mounting: without, type of packaging: packed in cardboard

XPC 1,5/ 3-ST-3,5 BK - PCB connector

1464105

<https://www.phoenixcontact.com/sk/products/1464105>

MC 1,5/ 3-G-3,5 P14 THRR32 - PCB header

1788974

<https://www.phoenixcontact.com/sk/products/1788974>



PCB headers, nominal cross section: 1.5 mm², color: black, nominal current: 8 A, rated voltage (III/2): 160 V, contact surface: Sn, contact connection type: Pin, number of potentials: 3, number of rows: 1, number of positions: 3, number of connections: 3, product range: MC 1,5/..-G-THR, pitch: 3.5 mm, mounting: THR soldering / wave soldering, pin layout: Linear pinning, solder pin [P]: 1.4 mm, number of solder pins per potential: 1, plug-in system: COMBICON MC 1,5, Pin connector pattern alignment: Standard, locking: without, mounting: without, type of packaging: 32 mm wide tape

MCV 1,5/ 3-G-3,5 - PCB header

1843619

<https://www.phoenixcontact.com/sk/products/1843619>

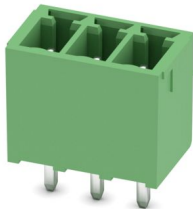

PCB headers, nominal cross section: 1.5 mm², color: green, nominal current: 8 A, rated voltage (III/2): 160 V, contact surface: Sn, contact connection type: Pin, number of potentials: 3, number of rows: 1, number of positions: 3, number of connections: 3, product range: MCV 1,5/..-G, pitch: 3.5 mm, mounting: Wave soldering, pin layout: Linear pinning, solder pin [P]: 3.4 mm, number of solder pins per potential: 1, plug-in system: COMBICON MC 1,5, Pin connector pattern alignment: Standard, locking: without, mounting: without, type of packaging: packed in cardboard

XPC 1,5/ 3-ST-3,5 BK - PCB connector

1464105

<https://www.phoenixcontact.com/sk/products/1464105>



MC 1,5/ 3-G-3,5 - PCB header

1844223

<https://www.phoenixcontact.com/sk/products/1844223>



PCB headers, nominal cross section: 1.5 mm², color: green, nominal current: 8 A, rated voltage (III/2): 160 V, contact surface: Sn, contact connection type: Pin, number of potentials: 3, number of rows: 1, number of positions: 3, number of connections: 3, product range: MC 1,5/..-G, pitch: 3.5 mm, screw head form: L Slotted, mounting: Wave soldering, pin layout: Linear pinning, solder pin [P]: 3.4 mm, number of solder pins per potential: 1, plug-in system: COMBICON MC 1,5, Pin connector pattern alignment: Standard, locking: without, mounting: without, type of packaging: packed in cardboard

Phoenix Contact 2024 © - all rights reserved

<https://www.phoenixcontact.com>

PHOENIX CONTACT s.r.o.

Námestie Mateja Korvína 1

811 07 Bratislava

+421 2 3210 1470

obchod.sk@phoenixcontact.com