

THIS DOCUMENT IS THE PROPERTY OF KEYSTONE ELECTRONICS CORP. AND SHALL NOT BE REPRODUCED, DISTRIBUTED OR USED AS A BASIS FOR MANUFACTURE WITHOUT PRIOR WRITTEN PERMISSION FROM KEYSTONE ELECTRONICS CORP.

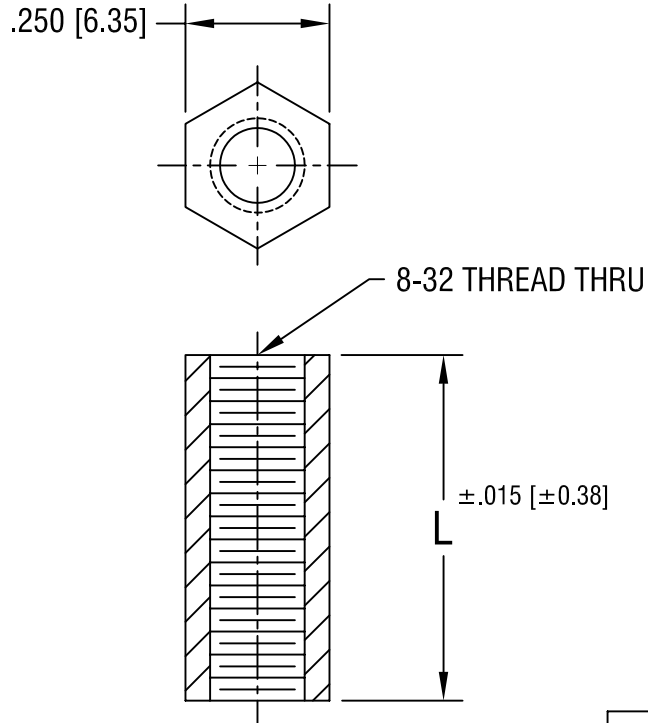

PART NO.	'L' DIM.
8442A	.250 [6.35]
8442B	.375 [9.52]
8442C	.500 [12.70]
8442D	.625 [15.87]
8442E	.750 [19.05]
8442F	.875 [22.22]
8442G	1.000 [25.4]

KEYSTONE ELECTRONICS CORP.			
ASTORIA, N.Y. 11105-2017			
PART NAME HEX STANDOFF, FLAME RETARDANT			
MATERIAL NYLON 6/6 UL 94V-0			
FINISH -		DRN BY BOONE	DATE 1.25.96
		APPD	SCALE 3X
TOLERANCES	INCH [MM]	CODE	DWG NO.
DECIMAL	± .005 [± 0.15]	C/M	8442-
ANGULAR	± 1°		
UNLESS OTHERWISE SPECIFIED			

DATE	DESCRIPTION	REV.