

THIS DOCUMENT IS THE PROPERTY OF
KEYSTONE ELECTRONICS CORP. AND
SHALL NOT BE REPRODUCED, DISTRIBUTED
OR USED AS A BASIS FOR MANUFACTURE
WITHOUT PRIOR WRITTEN PERMISSION
FROM KEYSTONE ELECTRONICS CORP.

ACTUAL SIZE

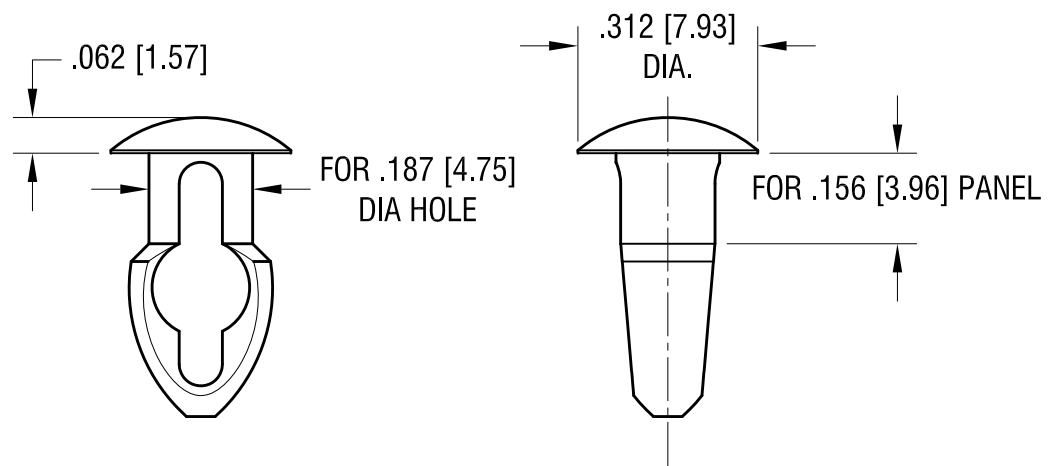

KEYSTONE ELECTRONICS CORP.

www.keyelco.com • ASTORIA, N.Y. 11105-2017 • Tel (718) 956-8900

PART NAME

KEY HOLE CLIP

MATERIAL

NYLON UL-94V2 - BLACK

FINISH

-

DRN BY

NT

DATE

10.07.13

APP'D

LN

SCALE

3X

TOLERANCES

INCH [MM]

CODE

DWG NO.

DECIMAL $\pm .015$ [± 0.38]

C

ANGULAR $\pm 1^\circ$
UNLESS OTHERWISE SPECIFIED

3321

DATE

DESCRIPTION

REV.