

Data sheet | Item number: 285-184

2-conductor through terminal block; 95 mm²; lateral marker slots; with fixing flanges; POWER CAGE CLAMP; 95,00 mm²; blue

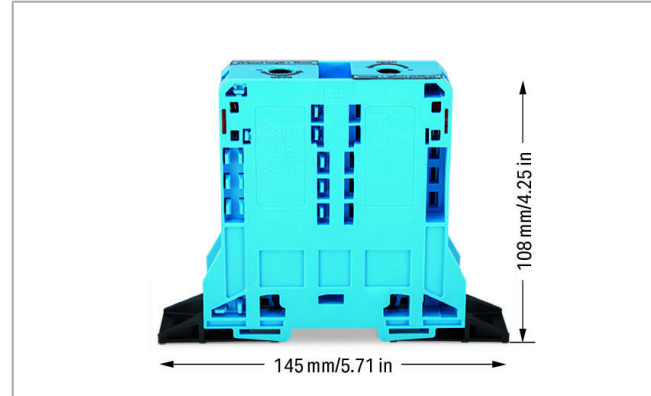

www.wago.com/285-184

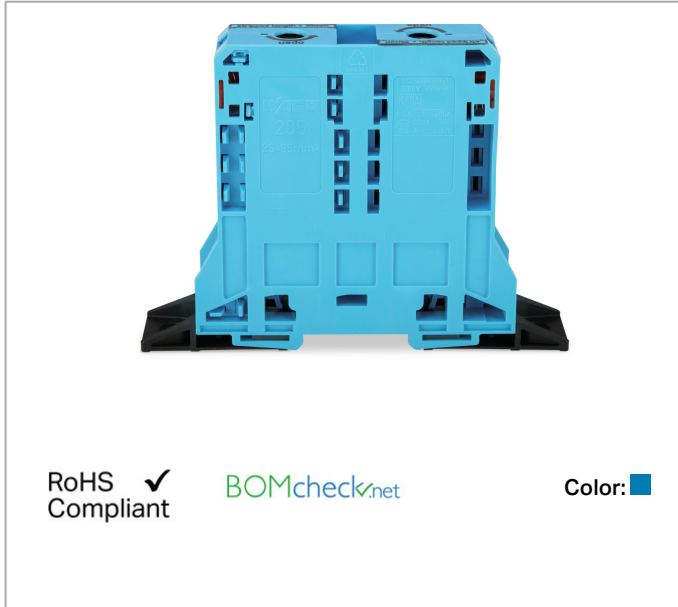

Data

Electrical data

Voltage type 1	AC/DC
Voltage type 2	DC

Ratings per IEC/EN

Ratings per	IEC/EN 60947-7-1
Nominal voltage (III/3)	1000 V
Rated surge voltage (III/3)	12 kV
Rated current	232 A
Rated voltage (III/3) 2	1500 V
Rated surge voltage (III/3) 2	12 kV
Legend (ratings)	(III / 3) ≙ Overvoltage category III / Pollution degree 3

Ratings per UL

Approvals per	UL 1059
Rated voltage UL (Use Group B)	600 V

Subject to changes. Please also observe the further product documentation!

WAGO Kontakttechnik GmbH & Co. KG
Hansastr. 27
32423 Minden
Phone: +49571 887-0 | Fax: +49571 887-169
Email: info.de@wago.com | Web: www.wago.com

Do you have any questions about our products?
We are always happy to take your call at +49 (571) 887-44222.



Rated current UL (Use Group B)	200 A
Rated voltage UL (Use Group C)	600 V
Rated current UL (Use Group C)	200 A

Ratings per CSA

Approvals per	C22.2 No 158
Rated voltage CSA (Use Group B)	1000 V
Rated current CSA (Use Group B)	210 A
Rated voltage CSA (Use Group C)	1000 V
Rated current CSA (Use Group D)	210 A

Connection data

Connection technology	POWER CAGE CLAMP
Actuation type	Operating tool
Connectable conductor materials	Copper
Solid conductor	25 ... 95 mm ² / 4 ... 4/0 AWG
Stranded conductor	25 ... 95 mm ² / 4 ... 4/0 AWG
Fine-stranded conductor	25 ... 95 mm ² / 4 ... 4/0 AWG
Strip length	35 mm / 1.38 inch
Total number of connection points	2
Total number of potentials	1
Number of levels	1
Wiring type	Side-entry wiring

Physical data

Width	25 mm / 0.984 inch
Height from the surface	108 mm / 4.252 inch
Depth	145 mm / 5.709 inch

Mechanical data

Design	horizontal type
Mounting type	Mounting flange
Marking level	Side marking

Material data

Color	blue
-------	------

Subject to changes. Please also observe the further product documentation!



Insulation material	Polyamide (PA66)
Weight	269.5 g

Commercial data



Packaging type	BOX
Country of origin	PL
GTIN	4055143583947
Customs tariff number	85369010000

Approvals / Certificates

Country specific Approvals

Logo	Approval	Additional Approval Text	Certificate name
	CCA DEKRA Certification B.V.	EN 60947	NTR NL-7707
	CSA DEKRA Certification B.V.	C22.2	1151144
	KEMA/KEUR DEKRA Certification B.V.	EN 60947	71-101911

Ship Approvals

Logo	Approval	Additional Approval Text	Certificate name
	ABS American Bureau of Shipping	EN 60947	20-HG1941090-PDA
	DNV GL Det Norske Veritas, Germanischer Lloyd	-	TAE00001V2

UL-Approvals

Logo	Approval	Additional Approval Text	Certificate name
	UL	UL 1059	E45172

Subject to changes. Please also observe the further product documentation!

Underwriters Laboratories Inc.



Compatible products

protection



Item no.: 285-169

Finger guard; touchproof cover protects unused conductor entries and jumper slots; for 95 mm² high-current tbs; yellow www.wago.com/285-169

Marking accessories



Item no.: 2009-115

WMB-Inline; for Smart Printer; 1500 pieces on roll; stretchable 5 - 5.2 mm; plain; snap-on type; white

www.wago.com/2009-115

Item no.: 2009-115/000-002

WMB-Inline; for Smart Printer; 1500 pieces on roll; stretchable 5 - 5.2 mm; plain; snap-on type; yellow

www.wago.com/2009-115/000-002

Item no.: 2009-115/000-005

WMB-Inline; for Smart Printer; 1500 pieces on roll; stretchable 5 - 5.2 mm; plain; snap-on type; red

www.wago.com/2009-115/000-005

Item no.: 2009-115/000-006

WMB-Inline; for Smart Printer; 1500 pieces on roll; stretchable 5 - 5.2 mm; plain; snap-on type; blue

www.wago.com/2009-115/000-006

Item no.: 2009-115/000-007

WMB-Inline; for Smart Printer; 1500 pieces on roll; stretchable 5 - 5.2 mm; plain; snap-on type; gray

www.wago.com/2009-115/000-007

Item no.: 2009-115/000-012

WMB-Inline; for Smart Printer; 1500 pieces on roll; stretchable 5 - 5.2 mm; plain; snap-on type; orange

www.wago.com/2009-115/000-012

Item no.: 2009-115/000-017

WMB-Inline; for Smart Printer; 1500 pieces on roll; stretchable 5 - 5.2 mm; plain; snap-on type; light green

www.wago.com/2009-115/000-017

Item no.: 2009-115/000-023

WMB-Inline; for Smart Printer; 1500 pieces on roll; stretchable 5 - 5.2 mm; plain; snap-on type; green

www.wago.com/2009-115/000-023

Item no.: 2009-115/000-024

WMB-Inline; for Smart Printer; 1500 pieces on roll; stretchable 5 - 5.2 mm; plain; snap-on type; violet

www.wago.com/2009-115/000-024

Item no.: 209-185

Adaptor; gray

www.wago.com/209-185

Subject to changes. Please also observe the further product documentation!

WAGO Kontakttechnik GmbH & Co. KG

Hansastr. 27















32423 Minden

Phone: +49571 887-0 | Fax: +49571 887-169

Email: info.de@wago.com | Web: www.wago.com

Do you have any questions about our products?

We are always happy to take your call at +49 (571) 887-44222.

	Item no.: 249-105 Group marker carrier; gray	www.wago.com/249-105
	Item no.: 285-442 Adaptor; gray	www.wago.com/285-442
	Item no.: 793-501 WMB marking card; as card; not stretchable; plain; snap-on type; white	www.wago.com/793-501
	Item no.: 793-501/000-002 WMB marking card; as card; not stretchable; plain; snap-on type; yellow	www.wago.com/793-501/000-002
	Item no.: 793-501/000-005 WMB marking card; as card; not stretchable; plain; snap-on type; red	www.wago.com/793-501/000-005
	Item no.: 793-501/000-006 WMB marking card; as card; not stretchable; plain; snap-on type; blue	www.wago.com/793-501/000-006
	Item no.: 793-501/000-007 WMB marking card; as card; not stretchable; plain; snap-on type; gray	www.wago.com/793-501/000-007
	Item no.: 793-501/000-012 WMB marking card; as card; not stretchable; plain; snap-on type; orange	www.wago.com/793-501/000-012
	Item no.: 793-501/000-017 WMB marking card; as card; not stretchable; plain; snap-on type; light green	www.wago.com/793-501/000-017
	Item no.: 793-501/000-023 WMB marking card; as card; not stretchable; plain; snap-on type; green	www.wago.com/793-501/000-023
	Item no.: 793-501/000-024 WMB marking card; as card; not stretchable; plain; snap-on type; violet	www.wago.com/793-501/000-024
	Item no.: 793-5501 WMB marking card; as card; for terminal block width 5 - 17.5 mm; stretchable 5 - 5.2 mm; plain; snap-on type; white	www.wago.com/793-5501
	Item no.: 793-5501/000-002 WMB marking card; as card; for terminal block width 5 - 17.5 mm; stretchable 5 - 5.2 mm; plain; snap-on type; yellow	www.wago.com/793-5501/000-002
	Item no.: 793-5501/000-005 WMB marking card; as card; for terminal block width 5 - 17.5 mm; stretchable 5 - 5.2 mm; plain; snap-on type; red	www.wago.com/793-5501/000-005
	Item no.: 793-5501/000-006	

Subject to changes. Please also observe the further product documentation!



WMB marking card; as card; for terminal block width 5 - 17.5 mm; stretchable 5 - 5.2 mm; plain; snap-on type; blue

www.wago.com/793-5501/000-006



Item no.: 793-5501/000-007

WMB marking card; as card; for terminal block width 5 - 17.5 mm; stretchable 5 - 5.2 mm; plain; snap-on type; gray

www.wago.com/793-5501/000-007



Item no.: 793-5501/000-012

WMB marking card; as card; for terminal block width 5 - 17.5 mm; stretchable 5 - 5.2 mm; plain; snap-on type; orange

www.wago.com/793-5501/000-012



Item no.: 793-5501/000-014

WMB marking card; as card; for terminal block width 5 - 17.5 mm; stretchable 5 - 5.2 mm; plain; snap-on type; brown

www.wago.com/793-5501/000-014



Item no.: 793-5501/000-017

WMB marking card; as card; for terminal block width 5 - 17.5 mm; stretchable 5 - 5.2 mm; plain; snap-on type; green

www.wago.com/793-5501/000-017



Item no.: 793-5501/000-023

WMB marking card; as card; for terminal block width 5 - 17.5 mm; stretchable 5 - 5.2 mm; plain; snap-on type; light green

www.wago.com/793-5501/000-023



Item no.: 793-5501/000-024

WMB marking card; as card; for terminal block width 5 - 17.5 mm; stretchable 5 - 5.2 mm; plain; snap-on type; violet

www.wago.com/793-5501/000-024

tools



Item no.: 285-172

Allen wrench; with a partially insulated shaft; green

www.wago.com/285-172



Item no.: 285-173

Allen wrench; with a partially insulated shaft; with anti-rotation protection; green

www.wago.com/285-173

Protective Warning Marker



Item no.: 285-170

Protective warning marker; with high-voltage symbol, black; yellow

www.wago.com/285-170



Item no.: 285-175

Protective warning marker; yellow

www.wago.com/285-175

ferrule



Item no.: 216-413

Ferrule; Sleeve for 25 mm² / AWG 4; uninsulated; electro-tin plated; electrolytic copper; gastight crimped; acc. to DIN 46228, Part 1/08.92; silver-colored

www.wago.com/216-413



Item no.: 216-414

Ferrule; Sleeve for 35 mm² / AWG 2; uninsulated; electro-tin plated; electrolytic copper; gastight crimped; acc. to DIN 46228, Part 1/08.92; silver-colored

www.wago.com/216-414



Item no.: 216-424

Ferrule; Sleeve for 35 mm² / AWG 2; uninsulated; electro-tin plated; electrolytic copper; gastight crimped; acc. to DIN 46228, Part 1/08.92; silver-colored

www.wago.com/216-424

Subject to changes. Please also observe the further product documentation!

WAGO Kontakttechnik GmbH & Co. KG

Hansastr. 27







32423 Minden

Phone: +49571 887-0 | Fax: +49571 887-169

Email: info.de@wago.com | Web: www.wago.com

Do you have any questions about our products?

We are always happy to take your call at +49 (571) 887-44222.

	Item no.: 216-425 Ferrule; Sleeve for 50 mm ² / AWG 1; uninsulated; electro-tin plated; electrolytic copper; gastight crimped; acc. to DIN 46228, Part 1/08.92	www.wago.com/216-425
	Item no.: 216-435 Ferrule; Sleeve for 50 mm ² / AWG 1; uninsulated; electro-tin plated; electrolytic copper; gastight crimped; acc. to DIN 46228, Part 1/08.92	www.wago.com/216-435
assembling		
	Item no.: 285-168 Fixing element; for 95 mm ² high-current terminal blocks; orange	www.wago.com/285-168
potential distribution		
	Item no.: 285-407 Power tap; for 95 mm ² high-current tbs; 10,00 mm ² ; gray	www.wago.com/285-407
	Item no.: 855-951/250-000 Current and voltage tap up to 95 mm ² ; Primary rated current: 250 A; Secondary rated current: 1 A; Rated power: 0.2 VA; Accuracy class: 0.5; fused	www.wago.com/855-951/250-000
Jumper		
	Item no.: 285-495 Jumper; insulated; gray	www.wago.com/285-495

Downloads

Documentation

Bid Text

285-184 doc - Datei	4. 1. 2018	doc 24.1 kB	Download
285-184 X81 - Datei	19. 2. 2019	xml 3.3 kB	Download

Additional Information

Technical explanations	3. 4. 2019	pdf 2.2 MB	Download
------------------------	------------	---------------	----------

CAD/CAE-Data

CAD data

2D/3D Models 285-184	URL	Download
----------------------	-----	----------

CAE data

EPLAN Data Portal 285-184	URL	Download
---------------------------	-----	----------

Subject to changes. Please also observe the further product documentation!

ZUKEN Portal 285-184

[URL](#)

[Download](#)

Environmental Product Compliance

Compliance Search

Environmental Product Compliance 285-184

[URL](#)

[Download](#)

2-conductor through terminal block; 95 mm²; lateral marker slots; with fixing flanges;
POWER CAGE CLAMP; 95,00 mm²; blue

Installation Notes

Installation

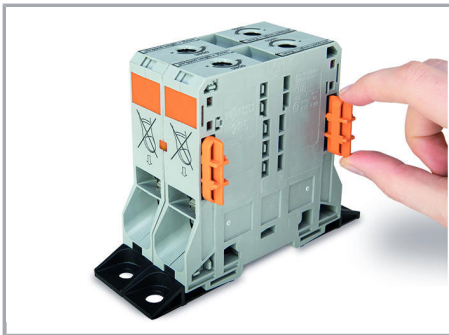

Optionally, insert block-to-block connector (285-168) into housing slot.

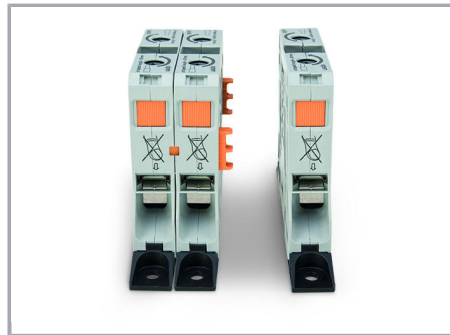

Align and snap high-current, through terminal blocks together.

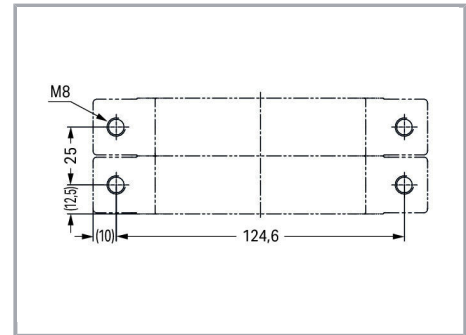

Product family

POWER CAGE CLAMP

[Show all products from the family](#)

Subject to changes. Please also observe the further product documentation!