

Data sheet | Item number: 2604-3304

PCB terminal block; lever; 4 mm<sup>2</sup>; Pin spacing 7.5 mm; 4-pole; Push-in CAGE CLAMP®; 4,00 mm<sup>2</sup>; gray

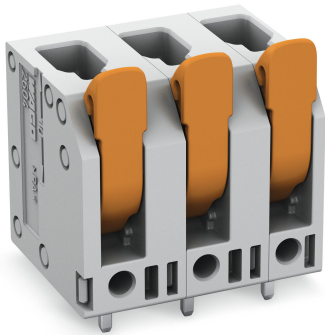

[www.wago.com/2604-3304](http://www.wago.com/2604-3304)



 Picture differs from the item.

RoHS  Compliant



Color: 

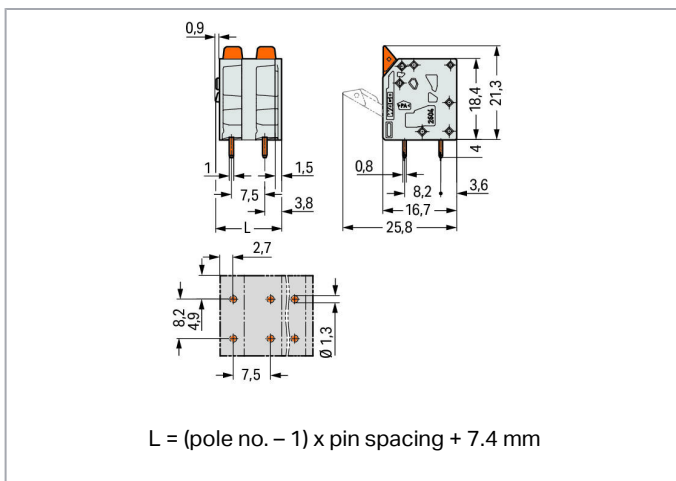
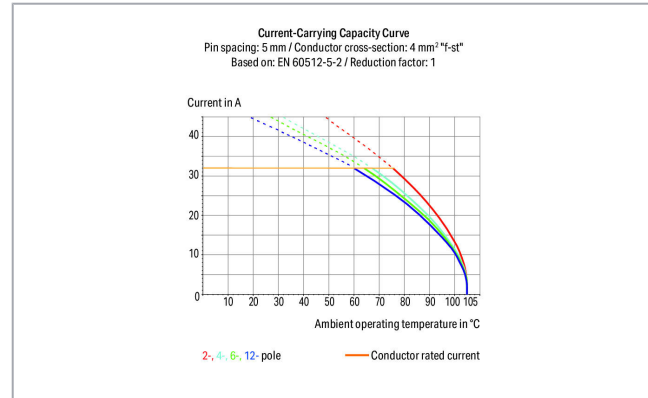

### Item description

- PCB terminal blocks with levers and Push-in CAGE CLAMP® connection
- Push-in termination of solid and ferruled conductors
- Intuitive and tool-free operation

Subject to changes. Please also observe the further product documentation!

WAGO Kontakttechnik GmbH & Co. KG  
Hansastr. 27  
32423 Minden  
Phone: +49571 887-0 | Fax: +49571 887-169  
Email: [info.de@wago.com](mailto:info.de@wago.com) | Web: [www.wago.com](http://www.wago.com)

Do you have any questions about our products?  
We are always happy to take your call at +49 (571) 887-44222.



- Several clamping units can be held open simultaneously – convenient for terminating multi-core cables
- Testing can be performed both parallel and perpendicular to conductor entry

## Data

### Electrical data

#### Ratings per IEC/EN

Ratings per	IEC/EN 60664-1
Nominal voltage (III/3)	630 V
Rated surge voltage (III/3)	6 kV
Rated voltage (III/2)	1000 V
Rated surge voltage (III/2)	6 kV
Nominal voltage (II/2)	1000 V
Rated surge voltage (II/2)	6 kV
Rated current	32 A
Legend (ratings)	(III / 2) $\hat{=}$ Overvoltage category III / Pollution degree 2

#### Ratings per UL

Approvals per	UL 1059
Rated voltage UL (Use Group B)	300 V
Rated current UL (Use Group B)	20 A
Rated voltage UL (Use Group C)	300 V
Rated current UL (Use Group C)	20 A
Rated voltage UL (Use Group D)	600 V
Rated current UL (Use Group D)	5 A

#### Ratings per CSA

Approvals per	CSA
Rated voltage CSA (Use Group B)	300 V
Rated current CSA (Use Group B)	20 A
Rated voltage CSA (Use Group C)	300 V
Rated current CSA (Use Group C)	20 A
Rated voltage CSA (Use Group D)	600 V
Rated current CSA (Use Group D)	5 A

Subject to changes. Please also observe the further product documentation!

## Connection data

Connection technology	Push-in CAGE CLAMP®
Actuation type	Lever
Solid conductor	0.2 ... 4 mm <sup>2</sup> / 24 ... 12 AWG
Fine-stranded conductor	0.2 ... 4 mm <sup>2</sup> / 24 ... 12 AWG
Fine-stranded conductor; with insulated ferrule	0.25 ... 2.5 mm <sup>2</sup>
Fine-stranded conductor; with uninsulated ferrule	0.25 ... 2.5 mm <sup>2</sup>
Fine-stranded conductor; with twin ferrule	0.25 ... 1.5 mm <sup>2</sup>
Strip length	9 ... 11 mm / 0.35 ... 0.43 inch
Conductor connection direction to PCB	90°
Pole No.	4
Total number of connection points	4
Total number of potentials	4
Number of connection types	1
Number of levels	1

## Physical data

Pin spacing	7.5 mm / 0.295 inch
Width	29.9 mm / 1.177 inch
Height	25.3 mm / 0.996 inch
Height from the surface	21.3 mm / 0.839 inch
Depth	16.7 mm / 0.657 inch
Solder pin length	4 mm
Solder pin dimensions	0.8 x 1 mm
Drilled hole diameter with tolerance	1.3 <sup>(+0.1)</sup> mm

## PCB contact

PCB Contact	THT
Solder pin arrangement	over the entire terminal strip (in-line)
Number of solder pins per potential	2

## Material data

Color	gray
Material group	I
Insulation material	Polyamide (PA66)

Subject to changes. Please also observe the further product documentation!

Flammability class per UL94	V0
Clamping spring material	Chrome nickel spring steel (CrNi)
Contact material	Electrolytic copper (E <sub>Cu</sub> )
Contact plating	tin-plated
Color of actuator	orange
Weight	8 g

### Environmental requirements



Limit temperature range	-60 ... +105 °C
-------------------------	-----------------

### Commercial data

Packaging type	BOX
Country of origin	DE
GTIN	4055143564847
Customs tariff number	85369010000

### Approvals / Certificates

#### Country specific Approvals

Logo	Approval	Additional Approval Text	Certificate name
	<b>CB</b> DEKRA Certification B.V.	EN 60947-7-4	NL-47057
	<b>CSA</b> DEKRA Certification B.V.	C22.2 No. 158	70117145
	<b>KEMA/KEUR</b> DEKRA Certification B.V.	EN 60947-7-4	71-100535







#### UL-Approvals

Logo	Approval	Additional Approval Text	Certificate name
	<b>cULus</b> Underwriters Laboratories Inc.	UL 1059	E45172

Subject to changes. Please also observe the further product documentation!

## Compatible products

### ferrule

	<b>Item no.: 216-106</b> Ferrule; Sleeve for 2.5 mm <sup>2</sup> / AWG 14; uninsulated; electro-tin plated; silver-colored	<a href="http://www.wago.com/216-106">www.wago.com/216-106</a>
	<b>Item no.: 216-241</b> Ferrule; Sleeve for 0.5 mm <sup>2</sup> / 20 AWG; insulated; electro-tin plated; electrolytic copper; gastight crimped; acc. to DIN 46228, Part 4/09.90; white	<a href="http://www.wago.com/216-241">www.wago.com/216-241</a>
	<b>Item no.: 216-242</b> Ferrule; Sleeve for 0.75 mm <sup>2</sup> / 18 AWG; insulated; electro-tin plated; electrolytic copper; gastight crimped; acc. to DIN 46228, Part 4/09.90; gray	<a href="http://www.wago.com/216-242">www.wago.com/216-242</a>
	<b>Item no.: 216-243</b> Ferrule; Sleeve for 1 mm <sup>2</sup> / AWG 18; insulated; electro-tin plated; electrolytic copper; gastight crimped; acc. to DIN 46228, Part 4/09.90; red	<a href="http://www.wago.com/216-243">www.wago.com/216-243</a>
	<b>Item no.: 216-244</b> Ferrule; Sleeve for 1.5 mm <sup>2</sup> / AWG 16; insulated; electro-tin plated; electrolytic copper; gastight crimped; acc. to DIN 46228, Part 4/09.90; black	<a href="http://www.wago.com/216-244">www.wago.com/216-244</a>
	<b>Item no.: 216-246</b> Ferrule; Sleeve for 2.5 mm <sup>2</sup> / AWG 14; insulated; electro-tin plated; electrolytic copper; gastight crimped; acc. to DIN 46228, Part 4/09.90; blue	<a href="http://www.wago.com/216-246">www.wago.com/216-246</a>

## Downloads

### Documentation

#### Additional Information

Technical explanations	3. 4. 2019	pdf 2.0 MB	Download
------------------------	------------	---------------	----------

## CAD/CAE-Data

### CAD data

2D/3D Models 2604-3304	URL	Download
------------------------	-----	----------

### PCB Design

Symbol and Footprint 2604-3304	URL	Download
--------------------------------	-----	----------

CAX data for your PCB design, consisting of "schematic symbols and PCB footprints", allow easy integration of the WAGO component into your development environment.

### Supported formats:

- Accel EDA 14 & 15
- Altium 6 to current version
- Cadence Allegro

Subject to changes. Please also observe the further product documentation!



- DesignSpark
- Eagle Libraries
- KiCad
- Mentor Graphics BoardStation
- Mentor Graphics Design Architect
- Mentor Graphics Design Expedition 99 and 2000
- OrCAD 9.X PCB and Capture
- PADS PowerPCB 3, 3.5, 4.X, and 5.X
- PADS PowerPCB and PowerLogic 3.0
- PCAD 2000, 2001, 2002, 2004, and 2006
- Pulsonix 8.5 or newer
- STL
- 3D STEP
- TARGET 3001!
- View Logic ViewDraw
- Quadcept
- Zuken CadStar 3 and 4
- Zuken CR-5000 and CR-8000

PCB Component Libraries (EDA), PCB CAD Library Ultra Librarian

---

#### CAE data

ZUKEN Portal 2604-3304	<a href="#">URL</a>	<a href="#">Download</a>
------------------------	---------------------	--------------------------

---

#### Environmental Product Compliance

##### Compliance Search

Environmental Product Compliance 2604-3304 PCB terminal block; lever; 4 mm <sup>2</sup> ; Pin spacing 7.5 mm; 4-pole; Push-in CAGE CLAMP®; 4,00 mm <sup>2</sup> ; gray	<a href="#">URL</a>	<a href="#">Download</a>
--	---------------------	--------------------------

---

#### Installation Notes

Subject to changes. Please also observe the further product documentation!

---

WAGO Kontakttechnik GmbH & Co. KG  
Hansastr. 27  
32423 Minden  
Phone: +49571 887-0 | Fax: +49571 887-169  
Email: [info.de@wago.com](mailto:info.de@wago.com) | Web: [www.wago.com](http://www.wago.com)

Do you have any questions about our products?  
We are always happy to take your call at +49 (571) 887-44222.