

926476-3 ✓ ACTIVE

AMPMODU | AMPMODU IV/V

TE Internal #: 926476-3

Housing, Receptacle, Wire-to-Board, 6 Position, .1 in [2.54 mm]

Centerline, Crimp, 2 Row, Black, Wire & Cable, Signal, AMPMODU IV/V

[View on TE.com >](#)



Connectors > PCB Connectors > Wire-to-Board Connectors > Wire-to-Board Connector Assemblies & Housings

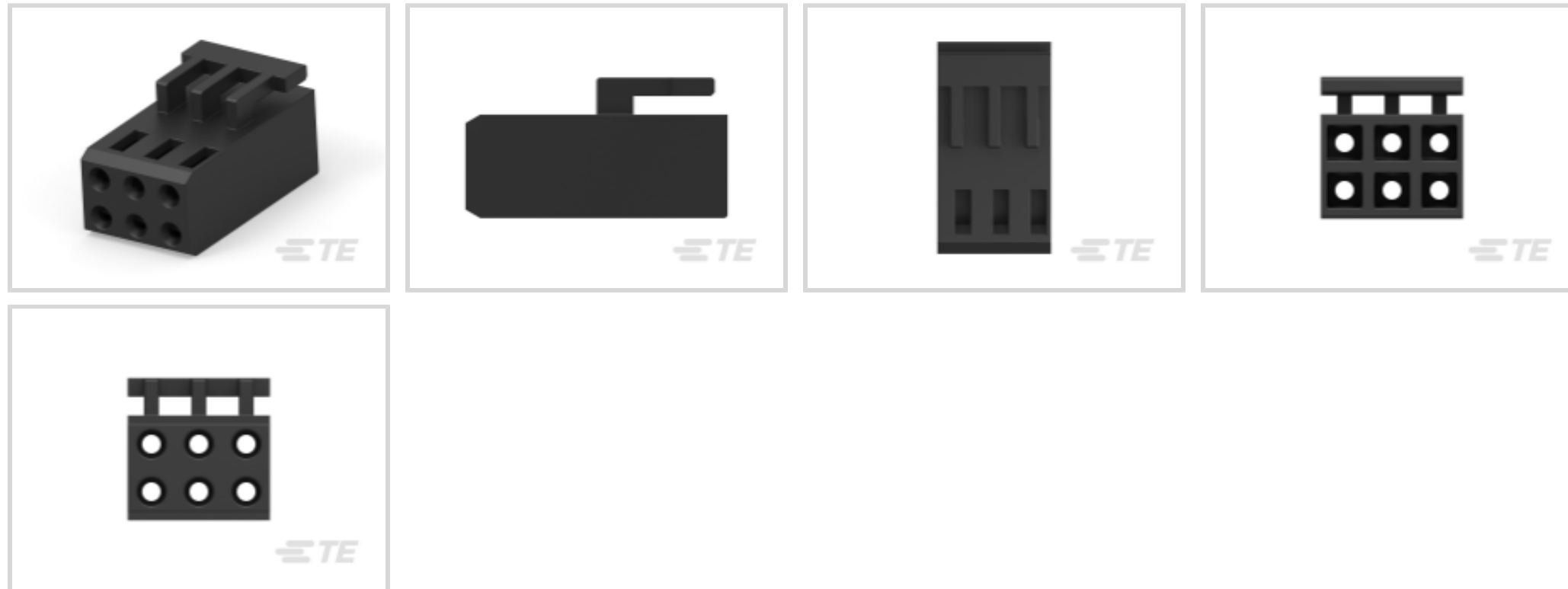

Connector Product Type: **Housing**

Connector & Housing Type: **Receptacle**

Connector System: **Wire-to-Board**

Number of Positions: **6**

Centerline (Pitch): **2.54 mm [.1 in]**

Features

Product Type Features

Connector Product Type	Housing
Connector & Housing Type	Receptacle
Connector System	Wire-to-Board
Connector & Contact Terminates To	Wire & Cable

Configuration Features

Number of Positions	6
Number of Rows	2

Electrical Characteristics

Operating Voltage	250 VAC
-------------------	---------

Body Features

Primary Product Color	Black
-----------------------	-------

Contact Features

Contact Type	Socket
--------------	--------



Contact Current Rating (Max)	3 A
------------------------------	-----

Termination Features

Termination Method to Wire & Cable	Crimp
------------------------------------	-------

Mechanical Attachment

Strain Relief	Without
---------------	---------

PCB Mount Retention	With
---------------------	------

Mating Retention	Without
------------------	---------

Connector Mounting Type	Cable Mount (Free-Hanging)
-------------------------	----------------------------

Housing Features

Housing Entry Configuration	Both Ends Closed
-----------------------------	------------------

Housing Material	Crastin SK642FR
------------------	-----------------

Centerline (Pitch)	2.54 mm[.1 in]
--------------------	----------------

Dimensions

Connector Length	7.62 mm[.29 in]
------------------	-----------------

Row-to-Row Spacing	2.54 mm[.1 in]
--------------------	----------------

Usage Conditions

Operating Temperature Range	-65 – 105 °C[-85 – 221 °F]
-----------------------------	----------------------------

Operation/Application

Circuit Application	Signal
---------------------	--------

Industry Standards

UL Flammability Rating	UL 94V-0
------------------------	----------

Packaging Features

Packaging Quantity	1000
--------------------	------

Packaging Method	Bag
------------------	-----

Product Compliance

[For compliance documentation, visit the product page on TE.com>](#)

EU RoHS Directive 2011/65/EU	Compliant
------------------------------	-----------

EU ELV Directive 2000/53/EC	Compliant
-----------------------------	-----------

China RoHS 2 Directive MIIT Order No 32, 2016	No Restricted Materials Above Threshold
---	---

EU REACH Regulation (EC) No. 1907/2006	Current ECHA Candidate List: JAN 2023 (233)
--	---



Candidate List Declared Against: JAN 2023
(233)

Does not contain REACH SVHC

Halogen Content

Not Low Halogen - contains Br or Cl > 900 ppm.

Solder Process Capability

Not applicable for solder process capability

Product Compliance Disclaimer

This information is provided based on reasonable inquiry of our suppliers and represents our current actual knowledge based on the information they provided. This information is subject to change. The part numbers that TE has identified as EU RoHS compliant have a maximum concentration of 0.1% by weight in homogenous materials for lead, hexavalent chromium, mercury, PBB, PBDE, DBP, BBP, DEHP, DIBP, and 0.01% for cadmium, or qualify for an exemption to these limits as defined in the Annexes of Directive 2011/65/EU (RoHS2). Finished electrical and electronic equipment products will be CE marked as required by Directive 2011/65/EU. Components may not be CE marked. Additionally, the part numbers that TE has identified as EU ELV compliant have a maximum concentration of 0.1% by weight in homogenous materials for lead, hexavalent chromium, and mercury, and 0.01% for cadmium, or qualify for an exemption to these limits as defined in the Annexes of Directive 2000/53/EC (ELV). Regarding the REACH Regulation, the information TE provides on SVHC in articles for this part number is based on the latest European Chemicals Agency (ECHA) 'Guidance on requirements for substances in articles' posted at this URL: <https://echa.europa.eu/guidance-documents/guidance-on-reach>

Compatible Parts

TE Part # 826470-3
2X3P MOD II SHROUDED HEADER, RT ANG.

TE Part # 826469-3
2X3P MOD II SHROUDED HEADER, ST

TE Part # 1-141708-1
MOD IV RECEPTACLE, CRIMP SNAP IN, LP

TE Part # 141708-1
MOD-4 REC.CONT.SCP.

TE Part # 926477-1
RETENTION FORK

TE Part # 926498-3
MOD2 KODIERSTUECK

TE Part # 167021-2
MOD-4 REC.CONT.SCP.

TE Part # 167301-4
MOD-4 REC.CONT.SCP.

TE Part # 2-167301-4
MOD-4 REC.CONT.SCP.

TE Part # 2-167301-2
MOD-4 REC.CONT.SCP.

TE Part # 166309-2
MOD-5 REC.CONTACT

TE Part # 167024-1
MOD-4 REC.CONT.SCP.

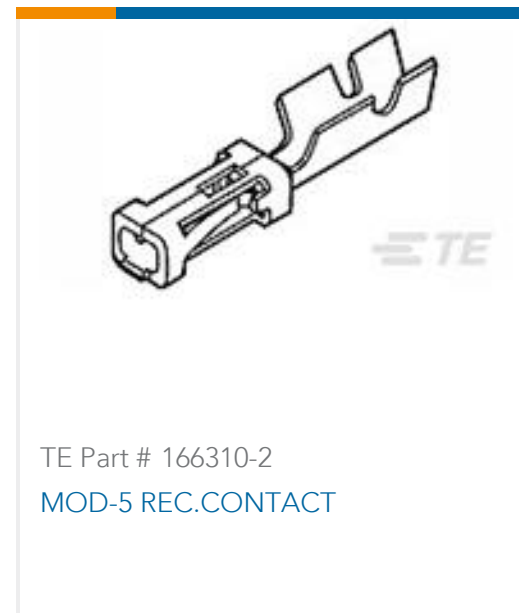
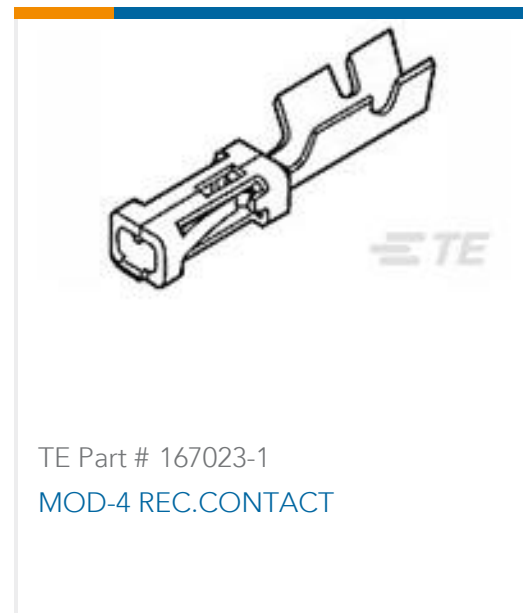
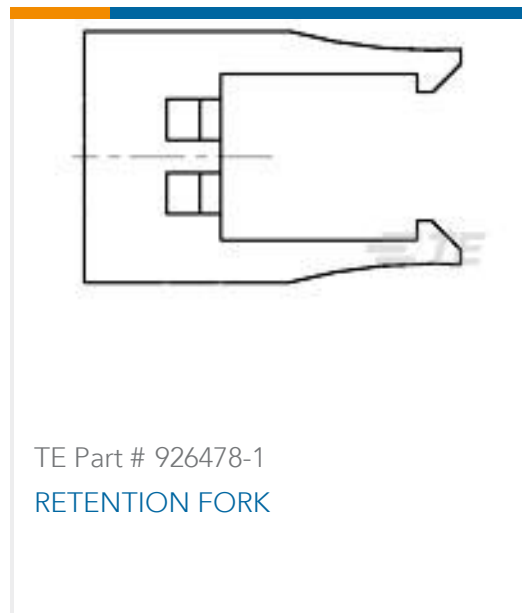

Also in the Series | AMPMODU IV/V

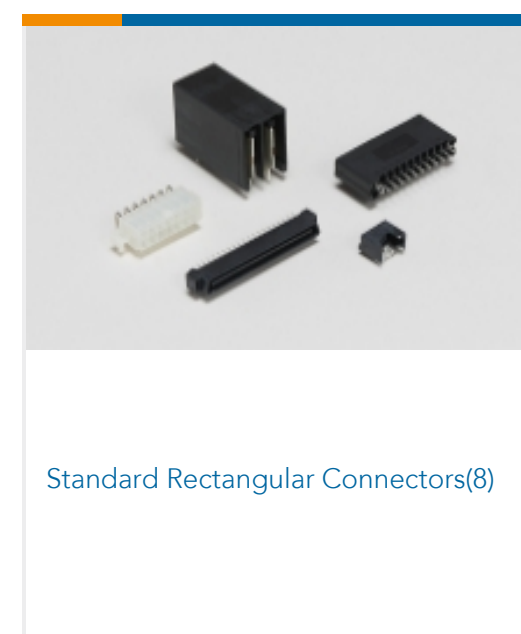
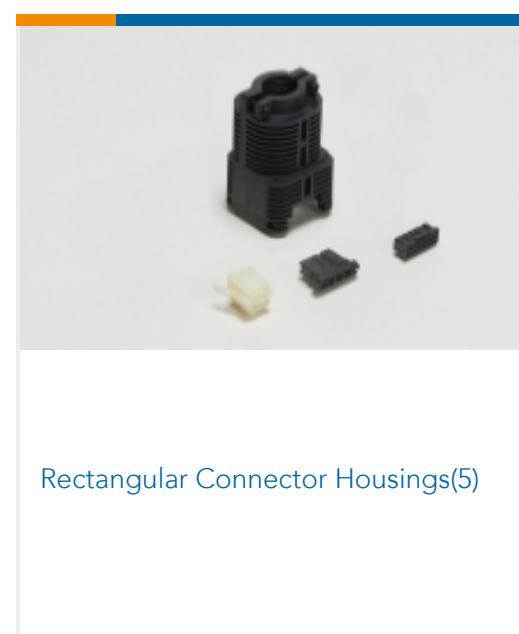
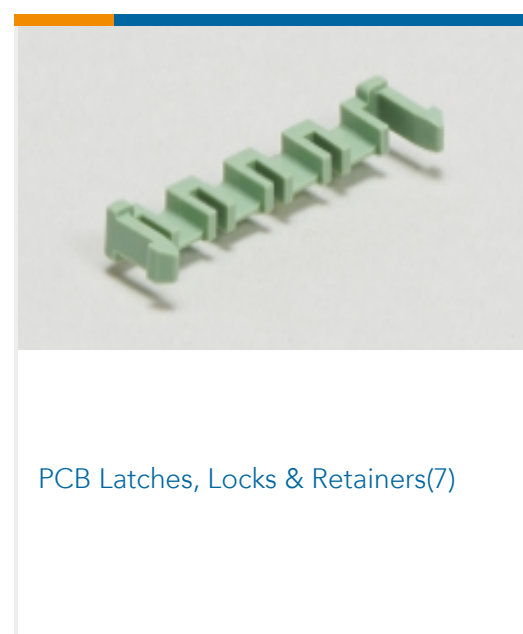
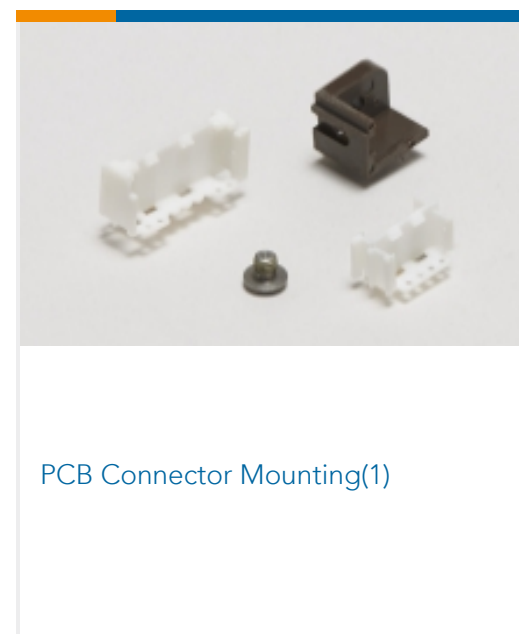
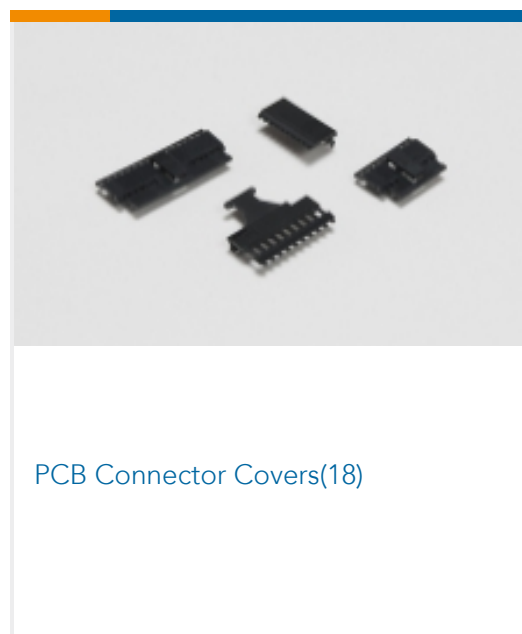
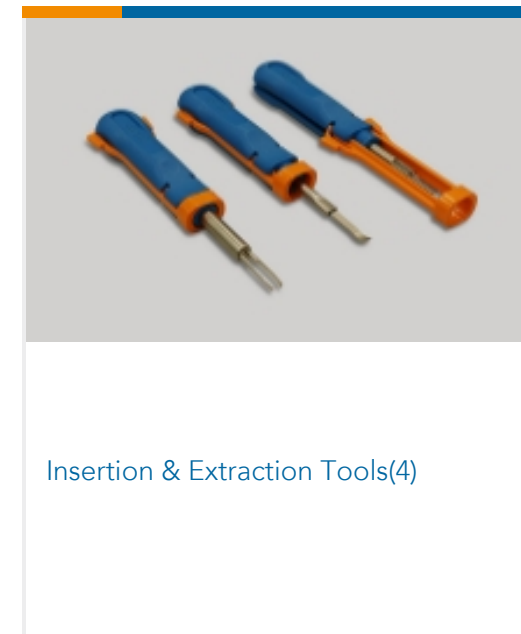
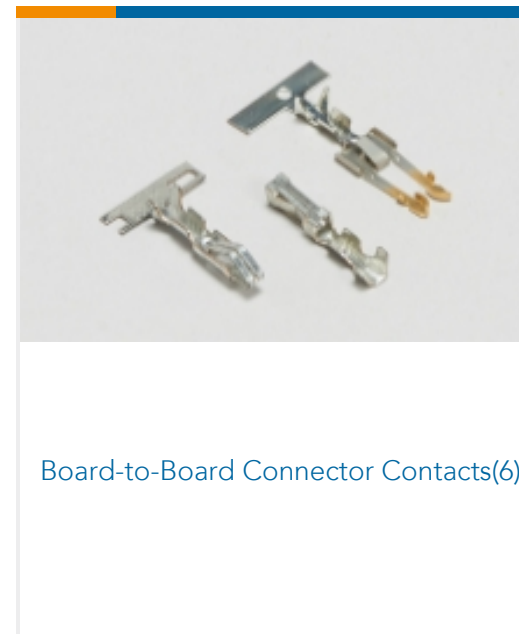
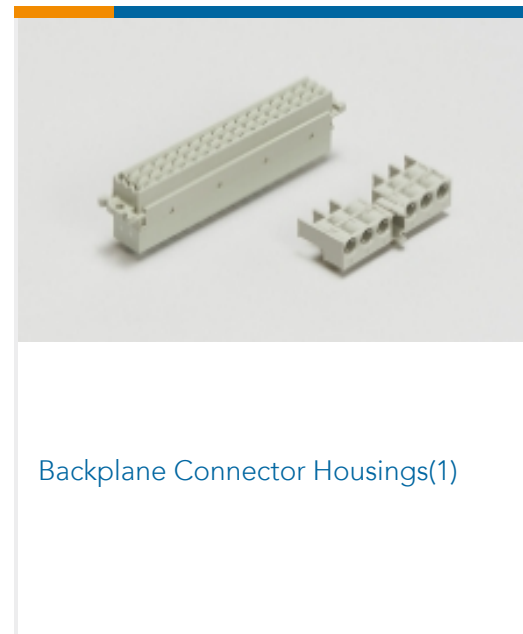
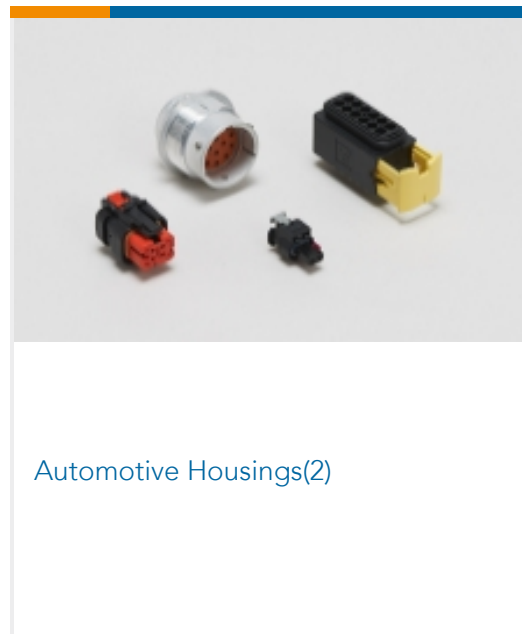

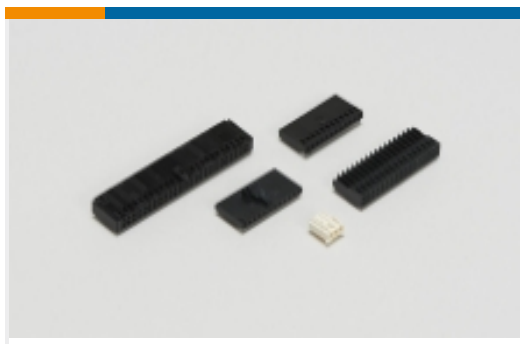

Wire-to-Board Connector Assemblies & Housings(465)



Wire-to-Board Connector Contacts (325)

Customers Also Bought



TE Part #1579007-9
EXTRACTION TOOL

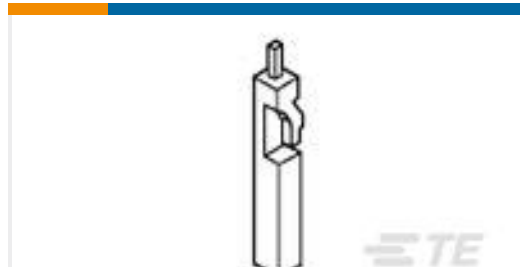

TE Part #926519-2
KEYING PLUG

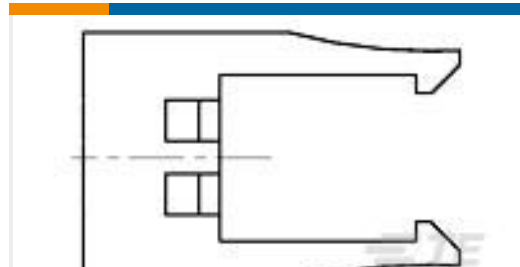

TE Part #926477-1
RETENTION FORK



TE Part #9-927742-2
2POS FASTIN FASTON HOUSING



TE Part #160101-2
RING TONGUE 20-16 AWG 0.0253
TPBR

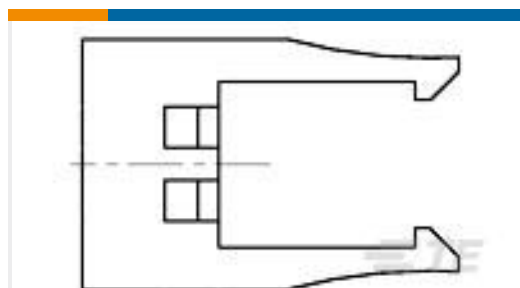

TE Part #926478-1
RETENTION FORK



TE Part #6-6437630-1
FTN59G04=LOCKING TOGGLE



TE Part #926475-5
MOD 4 HSG



TE Part #926476-4
2X4P MODU 4 HSG.

Documents

Product Drawings

MOD 4 HSG

English

CAD Files

3D PDF

English

Customer View Model

ENG_CVM_926476-3_O.3d_igs.zip



English

Customer View Model

[ENG_CVM_926476-3_O.3d_stp.zip](#)

English

Customer View Model

[ENG_CVM_926476-3_O.2d_dxf.zip](#)

English

By downloading the CAD file I accept and agree to the [Terms and Conditions](#) of use.

Product Specifications

[Product Specification](#)

English

Product Environmental Compliance

[Product Compliance](#)

English

[Product Compliance](#)

English

Agency Approvals

[UL Report](#)

English