

PICO-WHU4-SEMI

PICO-SEMI System

User's Manual 2nd Ed

Copyright Notice

This document is copyrighted, 2020. All rights are reserved. The original manufacturer reserves the right to make improvements to the products described in this manual at any time without notice.

No part of this manual may be reproduced, copied, translated, or transmitted in any form or by any means without the prior written permission of the original manufacturer. Information provided in this manual is intended to be accurate and reliable. However, the original manufacturer assumes no responsibility for its use, or for any infringements upon the rights of third parties that may result from its use.

The material in this document is for product information only and is subject to change without notice. While reasonable efforts have been made in the preparation of this document to assure its accuracy, AAEMON assumes no liabilities resulting from errors or omissions in this document, or from the use of the information contained herein.

AAEMON reserves the right to make changes in the product design without notice to its users.

Acknowledgement

All other products' name or trademarks are properties of their respective owners.

- Microsoft Windows® is a registered trademark of Microsoft Corp.
- Intel®, Celeron® are registered trademarks of Intel Corporation
- Core™ is a trademark of Intel Corporation
- ITE is a trademark of Integrated Technology Express, Inc.
- IBM, PC/AT, PS/2, and VGA are trademarks of International Business Machines Corporation.

All other product names or trademarks are properties of their respective owners.

Omission of a product name from this list does not imply any claim to ownership by the publisher of this document.

Packing List

Before setting up your product, please make sure the following items have been shipped:

Item	Quantity
● PICO-WHU4-SEMI	1

If any of these items are missing or damaged, please contact your distributor or sales representative immediately.

About this Document

This User's Manual contains all the essential information, such as detailed descriptions and explanations on the product's hardware and software features (if any), its specifications, dimensions, jumper/connector settings/definitions, and driver installation instructions (if any), to facilitate users in setting up their product.

Users may refer to the product page on AAEON.com for the latest version of this document.

Safety Precautions

Please read the following safety instructions carefully. It is advised that you keep this manual for future references

1. All cautions and warnings on the device should be noted.
2. Make sure the power source matches the power rating of the device.
3. Position the power cord so that people cannot step on it. Do not place anything over the power cord.
4. Always completely disconnect the power before working on the system's hardware.
5. No connections should be made when the system is powered as a sudden rush of power may damage sensitive electronic components.
6. If the device is not to be used for a long time, disconnect it from the power supply to avoid damage by transient over-voltage.
7. Always disconnect this device from any AC supply before cleaning.
8. While cleaning, use a damp cloth instead of liquid or spray detergents.
9. Make sure the device is installed near a power outlet and is easily accessible.
10. Keep this device away from humidity.
11. Place the device on a solid surface during installation to prevent falls
12. Do not cover the openings on the device to ensure optimal heat dissipation.
13. Watch out for high temperatures when the system is running.
14. Do not touch the heat sink or heat spreader when the system is running
15. Never pour any liquid into the openings. This could cause fire or electric shock.
16. As most electronic components are sensitive to static electrical charge, be sure to ground yourself to prevent static charge when installing the internal components. Use a grounding wrist strap and contain all electronic components in any static-shielded containers.

17. If any of the following situations arises, please contact our service personnel:
 - i. Damaged power cord or plug
 - ii. Liquid intrusion to the device
 - iii. Exposure to moisture
 - iv. Device is not working as expected or in a manner as described in this manual
 - v. The device is dropped or damaged
 - vi. Any obvious signs of damage displayed on the device
18. **DO NOT LEAVE THIS DEVICE IN AN UNCONTROLLED ENVIRONMENT WHERE THE STORAGE TEMPERATURE IS BELOW -20°C (-4°F) OR ABOVE 60°C (140°F) TO PREVENT DAMAGE.**

Warning!



This device complies with Part 15 FCC Rules. Operation is subject to the following two conditions: (1) this device may not cause harmful interference, and (2) this device must accept any interference received including interference that may cause undesired operation.

Caution:

There is a danger of explosion if the battery is incorrectly replaced. Replace only with the same or equivalent type recommended by the manufacturer. Dispose of used batteries according to the manufacturer's instructions and your local government's recycling or disposal directives.

Attention:

Il y a un risque d'explosion si la batterie est remplacée de façon incorrecte. Ne la remplacer qu'avec le même modèle ou équivalent recommandé par le constructeur. Recycler les batteries usées en accord avec les instructions du fabricant et les directives gouvernementales de recyclage.

产品中有毒有害物质或元素名称及含量

AAEON System

QO4-381 Rev.A0

部件名称	有毒有害物质或元素					
	铅 (Pb)	汞 (Hg)	镉 (Cd)	六价铬 (Cr(VI))	多溴联苯 (PBB)	多溴二苯 醚(PBDE)
印刷电路板 及其电子组件	×	○	○	○	○	○
外部信号 连接器及线材	×	○	○	○	○	○
外壳	○	○	○	○	○	○
中央处理器 与内存	×	○	○	○	○	○
硬盘	×	○	○	○	○	○
液晶模块	×	×	○	○	○	○
光驱	×	○	○	○	○	○
触控模块	×	○	○	○	○	○
电源	×	○	○	○	○	○
电池	×	○	○	○	○	○

本表格依据 SJ/T 11364 的规定编制。

○：表示该有毒有害物质在该部件所有均质材料中的含量均在 GB/T 26572 标准规定的限量要求以下。

×：表示该有害物质的某一均质材料超出了 GB/T 26572 的限量要求，然而该部件仍符合欧盟指令 2011/65/EU 的规范。

备注：

一、此产品所标示之环保使用期限，系指在一般正常使用状况下。

二、上述部件物质中央处理器、内存、硬盘、光驱、电源为选购品。

三、上述部件物质液晶模块、触控模块仅一体机产品适用。

Hazardous and Toxic Materials List

AAEON System

QO4-381 Rev.A0

Component Name	Hazardous or Toxic Materials or Elements					
	Lead (Pb)	Mercury (Hg)	Cadmium (Cd)	Hexavalent Chromium (Cr(VI))	Polybrominated biphenyls (PBBs)	Polybrominated ethers (PBDEs)
PCB and Components	X	O	O	O	O	O
Wires & Connectors for Ext.Connections	X	O	O	O	O	O
Chassis	O	O	O	O	O	O
CPU & RAM	X	O	O	O	O	O
HDD Drive	X	O	O	O	O	O
LCD Module	X	X	O	O	O	O
Optical Drive	X	O	O	O	O	O
Touch Control Module	X	O	O	O	O	O
PSU	X	O	O	O	O	O
Battery	X	O	O	O	O	O

This form is prepared in compliance with the provisions of SJ/T 11364.

O: The level of toxic or hazardous materials present in this component and its parts is below the limit specified by GB/T 26572.

X: The level of toxic of hazardous materials present in the component exceed the limits specified by GB/T 26572, but is still in compliance with EU Directive 2011/65/EU (RoHS 2).

Notes:

1. The Environment Friendly Use Period indicated by labelling on this product is applicable only to use under normal conditions.
2. Individual components including the CPU, RAM/memory, HDD, optical drive, and PSU are optional.
3. LCD Module and Touch Control Module only applies to certain products which feature these components.

Table of Contents

Chapter 1 - Product Specifications	1
1.1 Specifications	2
Chapter 2 – Hardware Information	5
2.1 Dimensions	6
2.2 Jumpers and Connectors.....	8
2.3 List of Jumpers	10
2.3.1 Clear CMOS Jumper, Auto Power Button Selection (JP2).....	10
2.4 List of Connectors.....	11
2.4.1 LPC Port (CN1)	12
2.4.2 COM Port 1/ COM Port 2 (CN2).....	13
2.4.3 Front Panel (CN3)	16
2.4.4 M.2 E-Key Connector (CN4)	17
2.4.5 Mini-Card Slot (Full-Size)/ mSATA (CN6).....	20
2.4.6 SATA Port (CN7)	22
2.4.7 LAN (RJ-45) Port1/ Port2 (CN8).....	23
2.4.8 +5V Output for SATA HDD (CN9).....	24
2.4.9 HDMI Port1/ Port2 (CN10)	24
2.4.10 Dual USB 3.2 Gen 2 (Port1/ Port2) (CN11)	26
2.4.11 External +12V Input (CN12)	27
2.4.12 DDR4 SO-DIMM Slot (CN14)	27
2.4.13 FAN Connector (CN15)	28
2.4.14 RTC Battery Connector (CN17)	28
2.4.15 Digital IO Port (CN18).....	29
2.4.16 USB 2.0 Port 1, 2 (CN19).....	29
2.5 Function Block.....	31
Chapter 3 - AMI BIOS Setup	32

3.1	System Test and Initialization	33
3.2	AMI BIOS Setup	34
3.3	Setup Submenu: Main	35
3.4	Setup Submenu: Advanced.....	36
3.4.1	Trusted Computing	37
3.4.2	CPU Configuration	39
3.4.3	SATA Configuration	40
3.4.4	Hardware Monitor	41
3.4.4.1	Smart Fan Mode Configuration	42
3.4.5	SIO Configuration	46
3.4.5.1	Serial Port 1 Configuration	47
3.4.5.2	Serial Port 2 Configuration.....	48
3.4.6	Power management	49
3.4.7	Digital IO Port Configuration	50
3.5	Setup Submenu: Chipset	51
3.5.1	System Agent (SA) Configuration.....	52
3.5.2	PCH-IO Configuration.....	53
3.5.2.1	Serial IO Configuration	54
3.6	Setup Submenu: Security.....	55
3.6.1	Secure Boot	56
3.6.1.1	Key Management.....	57
3.7	Setup submenu: Boot.....	59
3.7.1	BBS Priorities.....	60
3.8	Setup submenu: Exit	61
Chapter 4 – Drivers Installation.....		62
4.1	Drivers Download and Installation.....	63
Appendix A – Mating Connectors		65
A.1	List of Mating Connectors and Cables.....	66

Chapter 1

Product Specifications

1.1 Specifications

System

Form Factor	PICO-ITX
Processor	Intel 8th Generation Core i7/i5/i3/Celeron SoC i7-8665UE (4C, 1.7GHz, up to 4.4GHz) i5-8365UE (4C, 1.6GHz, up to 4.1GHz) i3-8145UE (2C, 2.2GHz, up to 3.9GHz) Celeron 4305UE (2C, 2GHz)
System Memory	Non-ECC DDR4 2400MHz SODIMM x 1, Max. 32 GB
Chipset	Intel SoC
Ethernet	Realtek 8111G Gigabit Ethernet 10/100/1000Mbps, RJ-45 x2
BIOS	UEFI only
Wake on LAN	Yes
Watchdog Timer	255 Levels
Expansion Interface	2230 M.2 E-Key x 1 (for Wi-Fi, Bluetooth, PCIe/USB signal only) SMBUS/I2C/LPC/eSPI x 1
Power Requirement	Normal: +12V
Power Supply Type	Lockable
Power Consumption (Typical)	30.36W (average) 93.12W (maximum)
System Size	5.9" x 3.94" x 2.36" (150mm x 100mm x 60mm)

System

Gross Weight	982g (including packing)
	635g (excluding packing)
Operation Temperature	32°F ~ 122°F (0°C ~ 50°C) without airflow 0.5 m/s for SSD SKU
Storage Temperature	-40°F ~ 176°F (-40°C ~ 80°C)
Humidity	0% ~ 90% relative humidity, non-condensing
MTBF	298,762 hours

Display

Chipset	Intel SoC
Video Output	HDMI 1.4
Touch	—

I/O

Storage/SSD	SATA 6.0Gb/s x 1, (5V Power) supports 2.5" SSD mini-PCIe (Full-Sized) x 1 (PCIe[x1] x1, USB3.2/ 2.0, SATA)
USB Port	USB 3.2 Gen 2 x 2 (Rear IO) USB 2.0 x 2 (Via cable to Rear IO)
Serial Port	RS-232/422/485 x 2 (Optional)
Audio	—
Expansion Slot	—

Certification

Certification

CE, FCC

Chapter 2

Hardware Information

2.1 Dimensions

System

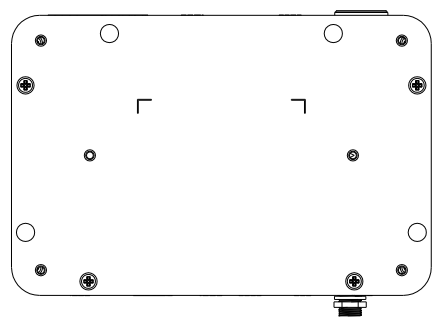
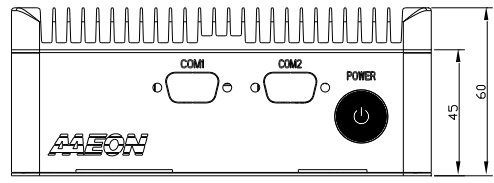
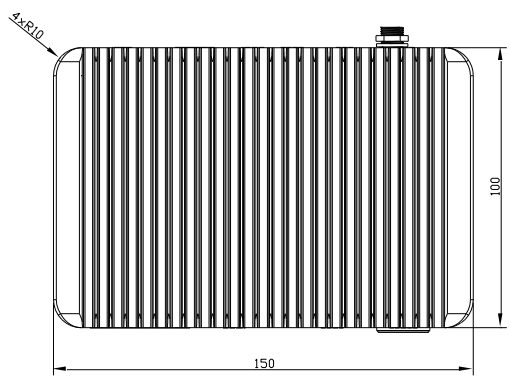

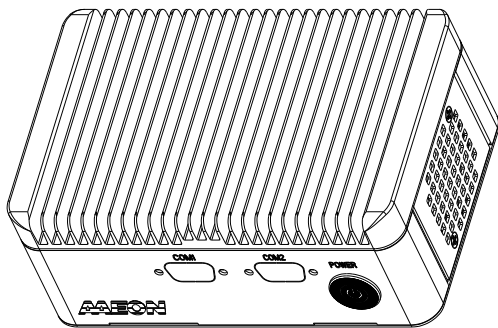
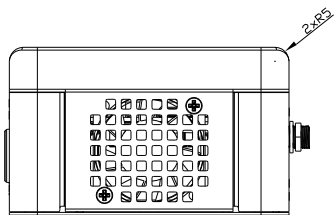

2.2 Jumpers and Connectors

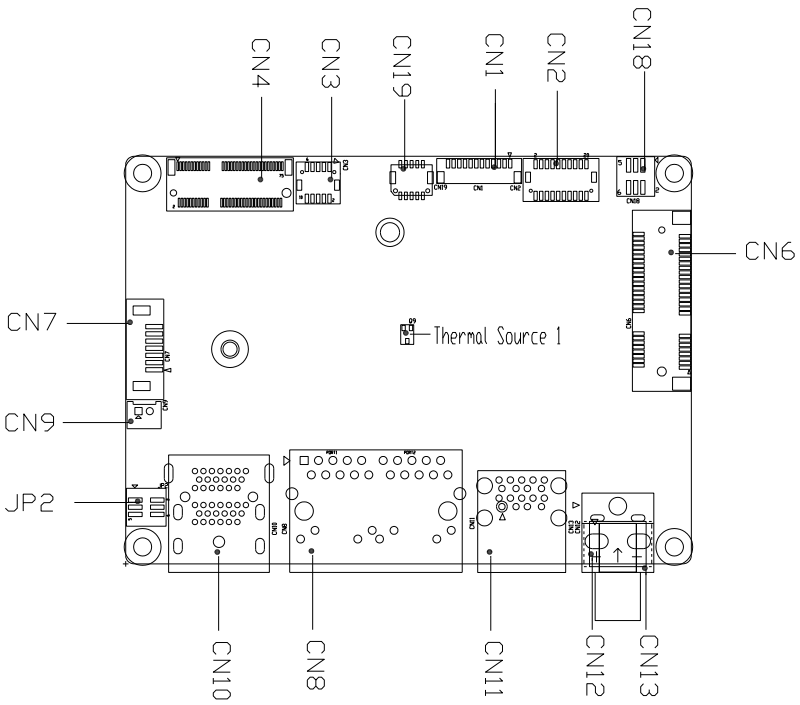

Component Side

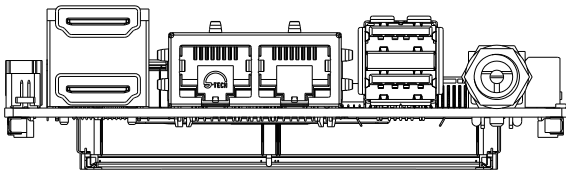

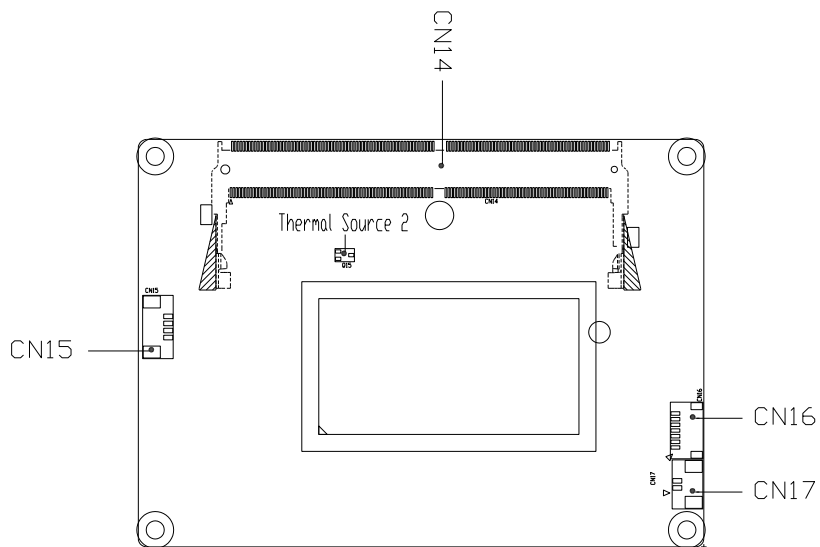

Solder Side

2.3 List of Jumpers

Please refer to the table below for all of the board's jumpers that you can configure for your application

Label	Function
JP2	Clear CMOS Jumper, Auto Power Button Selection

2.3.1 Clear CMOS Jumper, Auto Power Button Selection (JP2)

Clear CMOS Jumper

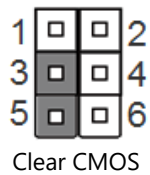
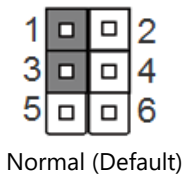

Auto Power Button Enable/Disable Selection

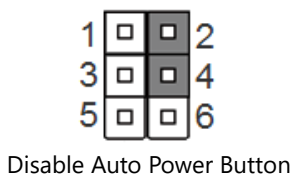
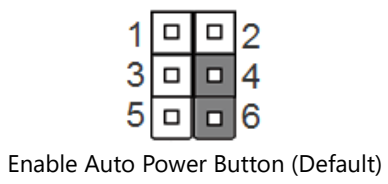

Note: To avoid damage to the system, do not connect pins 1,3,5 with pins 2,4,6.

2.4 List of Connectors

Please refer to the table below for all of the board's connectors that you can configure for your application

Label	Function
CN1	LPC Port
CN2	COM Port1/ COM Port2
CN3	Front Panel
CN4	M.2 (E-Key) Connector
CN6	Mini-Card Slot (Full Size)/mSATA
CN7	SATA Port
CN8	LAN (RJ-45) Port1/ Port2
CN9	+5V Output for SATA HDD
CN10	HDMI Port1/ Port2
CN11	Dual USB 3.2 Gen 2 (Port1/ Port2)
CN12	External +12V Input
CN14	DDR4 SO-DIMM Slot
CN15	FAN Connector
CN17	RTC Battery Connector
CN18	Digital IO Port
CN19	USB 2.0 Port (Port1/ Port2)

2.4.1 LPC Port (CN1)

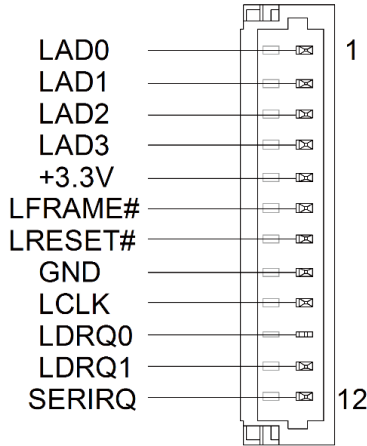

Pin	Pin Name	Signal Type	Signal Level
1	LAD0	IN/OUT	+3.3V
2	LAD1	IN/OUT	+3.3V
3	LAD2	IN/OUT	+3.3V
4	LAD3	IN/OUT	+3.3V
5	+V3.3S	PWR	+3.3V
6	LFRAME#	IN	
7	LRESET#	OUT	+3.3V
8	GND	GND	GND
9	LCLK	OUT	
10	SMB_DATA/ I2C_SDA	IN/OUT	
11	SMB_CLK/ I2C_CLK	OUT	
12	SMB_ALERT/ INT_SERIRQ	IN	+3.3V

2.4.2 COM Port 1/ COM Port 2 (CN2)

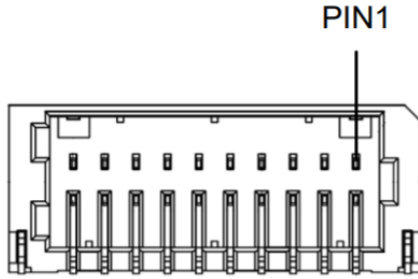

Pin	Pin Name	Signal Type	Signal Level
1	NC	NC	NC
2	NC	NC	NC
3	GND	GND	GND
4	NC	NC	NC
5	DCDA	IN	
6	DCDB	IN	
7	RXA	IN	
8	RXB	IN	
9	TXA	OUT	±9V
10	TXB	OUT	±9V
11	DTRA	OUT	±9V
12	DTRB	OUT	±9V
13	DSRA	IN	
14	DSRB	IN	
15	RTSA	OUT	±9V
16	RTSB	OUT	±9V
17	CTSA	IN	
18	CTSB	IN	

Pin	Pin Name	Signal Type	Signal Level
19	RIA/+5V/+12V	IN/ PWR	+5V/+12V
20	RIB/+5V/+12V	IN/ PWR	+5V/+12V

COM Port 1 RS-422

Pin	Pin Name	Signal Type	Signal Level
3	GND	GND	GND
5	RS422_TX-	OUT	±5V
7	RS422_TX+	OUT	±5V
9	RS422_RX+	IN	
11	RS422_RX-	IN	

COM Port 1 RS-485

Pin	Pin Name	Signal Type	Signal Level
3	GND	GND	GND
5	RS485_D-	I/O	±5V
7	RS485_D+	I/O	±5V

Note: COM1 RS-232/422/485 can be set by BIOS settings. Default is RS-232.

Note: COM1 RI/ +5V/ +12V function can be set by BOM (R318: RI/ R320: +12V/ R319: +5V)

COM Port 2 RS-422

Pin	Pin Name	Signal Type	Signal Level
3	GND	GND	GND
6	RS422_TX-	OUT	±5V
8	RS422_TX+	OUT	±5V
10	RS422_RX+	IN	
12	RS422_RX-	IN	

COM Port 2 RS-485

Pin	Pin Name	Signal Type	Signal Level
3	GND	GND	GND
6	RS485_D-	I/O	±5V
8	RS485_D+	I/O	±5V

Note: COM2 RS-232/422/485 can be set by BIOS settings. Default is RS-232.

Note: COM2 RI/ +5V/ +12V function can be set by BOM (R315: RI/ R316: +12V/ R313: +5V)

2.4.3 Front Panel (CN3)

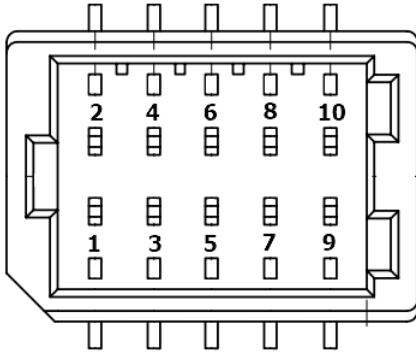

Pin	Pin Name	Signal Type	Signal Level
1	GND	GND	GND
2	EXT_PWRBTN#	IN	
3	SATA_LED-	OUT	
4	SATA_LED+	OUT	
5	BUZZER-	OUT	
6	BUZZER+	OUT	
7	GND	GND	GND
8	PWR_LED+	OUT	
9	GND	GND	GND
10	HWRST#	IN	

2.4.4 M.2 E-Key Connector (CN4)

Pin	Pin Name	Signal Type	Signal Level
1	GND	GND	GND
2	+V3.3A	PWR	+3.3V
3	USB2P_5	IN/OUT	
4	+V3.3A	PWR	+3.3V
5	USB2N_5	IN/OUT	
6	NC	NC	
7	GND	GND	GND
8	NC	NC	
9	NC	NC	
10	NC	NC	
11	NC	NC	
12	NC	NC	
13	NC	NC	
14	NC	NC	
15	NC	NC	
16	NC	NC	
17	NC	NC	
18	GND	GND	
19	NC	NC	
20	NC	NC	
21	NC	NC	
22	NC	NC	
23	NC	NC	
32	NC	NC	

Pin	Pin Name	Signal Type	Signal Level
33	GND	GND	GND
34	NC	NC	
35	PCIE1_TXP	DIFF	
36	NC	NC	
37	PCIE1_TXN	DIFF	
38	NC	NC	
39	GND	GND	GND
40	NC	NC	
41	PCIE1_RXP	DIFF	
42	NC	NC	
43	PCIE1_RXN	DIFF	
44	NC	NC	
45	GND	GND	GND
46	NC	NC	
47	PCIE1_CLKP	DIFF	
48	NC	NC	
49	PCIE1_CLKN	DIFF	
50	SUSCLK	OUT	
51	GND	GND	GND
52	BUF_PLT_RST#	OUT	
53	PCIE_CLK_REQ1#	IN	
54	W_DISABLE2#	OUT	
55	PCIE_WAKE#	IN	
56	W_DISABLE1#	OUT	
57	GND	GND	GND
58	NC	NC	

Pin	Pin Name	Signal Type	Signal Level
59	NC	NC	
60	NC	NC	
61	NC	NC	
62	NC	NC	
63	GND	GND	GND
64	NC	NC	
65	NC	NC	
66	NC	NC	
67	NC	NC	
68	NC	NC	
69	GND	GND	GND
70	NC	NC	
71	NC	NC	
72	+V3.3A	PWR	+3.3V
73	NC	NC	
74	+V3.3A	PWR	+3.3V
75	GND	GND	GND

2.4.5 Mini-Card Slot (Full-Size)/ mSATA (CN6)

Pin	Pin Name	Signal Type	Signal Level
1	PCIE_WAKE#	IN	
2	+3.3VSB/+3.3V	PWR	+3.3V
3	NC	NC	
4	GND	GND	
5	NC	NC	
6	+1.5V	PWR	+1.5V
7	PCIE_CLK_REQ#	IN	
8	NC	NC	
9	GND	GND	
10	NC	NC	
11	PCIE_REF_CLK-	DIFF	
12	NC	NC	
13	PCIE_REF_CLK+	DIFF	
14	NC	NC	
15	GND	GND	
16	NC	NC	
17	NC	NC	
18	GND	GND	
19	NC	NC	
20	W_DISABLE#	OUT	+3.3V
21	GND	GND	
22	PCIE_RST#	OUT	+3.3V
23	PCIE_RX+/ mSATARX+	DIFF	
24	+3.3VSB/+3.3V	PWR	+3.3V

Pin	Pin Name	Signal Type	Signal Level
25	PCIE_RX-/ mSATARX-	DIFF	
26	GND	GND	
27	GND	GND	
28	+1.5V	PWR	+1.5V
29	GND	GND	
30	SMB_CLK	I/O	+3.3V
31	PCIE_TX-/mSATATX-	DIFF	
32	SMB_DATA	I/O	+3.3V
33	PCIE_TX+/mSATATX+	DIFF	
34	GND	GND	
35	GND	GND	
36	USB_D-	DIFF	
37	GND	GND	
38	USB_D+	DIFF	
39	+3.3VSB/+3.3V	PWR	+3.3V
40	GND	GND	
41	+3.3VSB/+3.3V	PWR	+3.3V
42	NC	NC	
43	SATAXPCE0	GND	
44	NC	NC	
45	NC	NC	
46	NC	NC	
47	NC	NC	
48	+1.5V	PWR	+1.5V
49	NC	NC	
50	GND	GND	

Pin	Pin Name	Signal Type	Signal Level
51	NC	NC	
52	+3.3VSB/+3.3V	PWR	+3.3V

2.4.6 SATA Port (CN7)

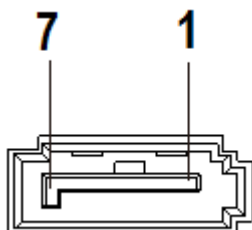

Pin	Pin Name	Signal Type	Signal Level
1	GND	GND	
2	SATA_TX+	DIFF	
3	SATA_TX-	DIFF	
4	GND	GND	
5	SATA_RX-	DIFF	
6	SATA_RX+	DIFF	
7	GND	GND	

2.4.7 LAN (RJ-45) Port1/ Port2 (CN8)

Pin	Pin Name	Signal Type	Signal Level
1P1	LAN1_MDI0_P	DIFF	
1P2	LAN1_MDI0_N	DIFF	
1P3	LAN1_MDI1_P	DIFF	
1P4	LAN1_MDI1_N	DIFF	
1P7	LAN1_MDI2_P	DIFF	
1P8	LAN1_MDI2_N	DIFF	
1P9	LAN1_MDI3_P	DIFF	
1P10	LAN1_MDI3_N	DIFF	
2P1	LAN2_MDI0_P	DIFF	
2P2	LAN2_MDI0_N	DIFF	
2P3	LAN2_MDI1_P	DIFF	
2P4	LAN2_MDI1_N	DIFF	
2P7	LAN2_MDI2_P	DIFF	
2P8	LAN2_MDI2_N	DIFF	
2P9	LAN2_MDI3_P	DIFF	
2P10	LAN2_MDI3_N	DIFF	

2.4.8 +5V Output for SATA HDD (CN9)

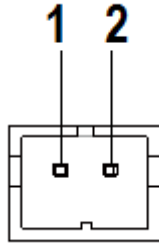

Pin	Pin Name	Signal Type	Signal Level
1	+V5S	PWR	+5V
2	GND	GND	GND

2.4.9 HDMI Port1/ Port2 (CN10)

Pin	Pin Name	Signal Type	Signal Level
1	HDMI1_TX2+	DIFF	
2	GND	GND	GND
3	HDMI1_TX2-	DIFF	
4	HDMI1_TX1+	DIFF	
5	GND	GND	GND
6	HDMI1_TX1-	DIFF	
7	HDMI1_TX0+	DIFF	
8	GND	GND	GND
9	HDMI1_TX0-	DIFF	
10	HDMI1_CLK+	DIFF	
11	GND	GND	GND
12	HDMI1_CLK-	DIFF	
13	NC		

Pin	Pin Name	Signal Type	Signal Level
14	NC		
15	DDC1_CLK	I/O	+5V
16	DDC1_DATA	I/O	+5V
17	GND	GND	GND
18	+5V	PWR	+5V
19	HDMI1_HPD		
20	HDMI2_TX2+	DIFF	
21	GND	GND	GND
22	HDMI2_TX2-	DIFF	
23	HDMI2_TX1+	DIFF	
24	GND	GND	GND
25	HDMI2_TX1-	DIFF	
26	HDMI2_TX0+	DIFF	
27	GND	GND	GND
28	HDMI2_TX0-	DIFF	
29	HDMI2_CLK+	DIFF	
30	GND	GND	GND
31	HDMI2_CLK-	DIFF	
32	NC		
33	NC		
34	DDC2_CLK	I/O	+5V
35	DDC2_DATA	I/O	+5V
36	GND	GND	GND
37	+5V	PWR	+5V
38	HDMI2_HPD		

2.4.10 Dual USB 3.2 Gen 2 (Port1/ Port2) (CN11)

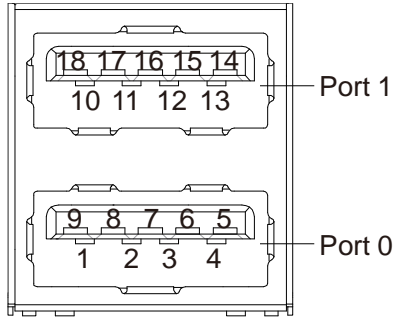

Pin	Pin Name	Signal Type	Signal Level
1	+V5SB	PWR	+5V
2	USB2_2_DN	DIFF	
3	USB2_2_DP	DIFF	
4	GND	GND	GND
5	USB3_2_RXN	DIFF	
6	USB3_2_RXP	DIFF	
7	GND	GND	GND
8	USB3_2_TXN	DIFF	
9	USB3_2_TXP	DIFF	
10	+V5SB	PWR	+5V
11	USB2_3_DN	DIFF	
12	USB2_3_DP	DIFF	
13	GND	GND	GND
14	USB3_3_RXN	DIFF	
15	USB3_3_RXP	DIFF	
16	GND	GND	GND

Pin	Pin Name	Signal Type	Signal Level
17	USB3_3_TXN	DIFF	
18	USB3_3_TXP	DIFF	

2.4.11 External +12V Input (CN12)

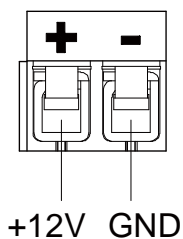

Pin	Pin Name	Signal Type	Signal Level
1	+12V	PWR	+12V
2	GND	GND	GND

2.4.12 DDR4 SO-DIMM Slot (CN14)

Standard specification.

2.4.13 FAN Connector (CN15)

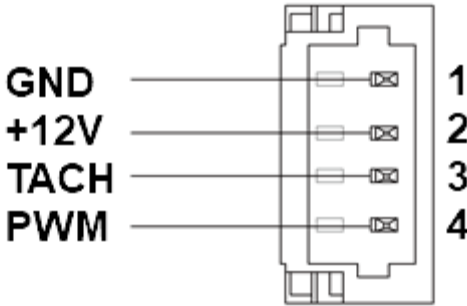

Pin	Pin Name	Signal Type	Signal Level
1	GND	GND	GND
2	+V12S	PWR	+12V
3	TACH	IN	
4	PWM	OUT	

2.4.14 RTC Battery Connector (CN17)

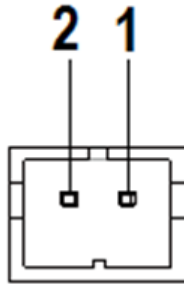

Pin	Pin Name	Signal Type	Signal Level
1	+3.3V	PWR	+3.3V
2	GND	GND	GND

2.4.15 Digital IO Port (CN18)

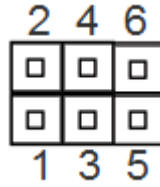

Pin	Pin Name	Signal Type	Signal Level
1	+5V	PWR	+5V
2	DIO_0	IN/OUT	
3	DIO_1	IN/OUT	
4	DIO_2	IN/OUT	
5	DIO_3	IN/OUT	
6	GND	GND	GND

2.4.16 USB 2.0 Port 1, 2 (CN19)

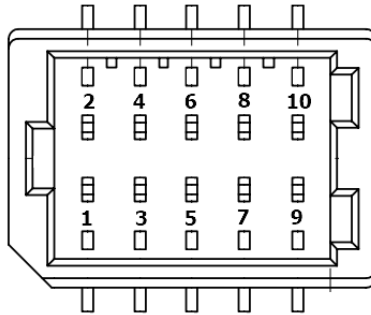

Pin	Pin Name	Signal Type	Signal Level
1	+5VSB	PWR	+5V
2	+5VSB	PWR	+5V

Pin	Pin Name	Signal Type	Signal Level
3	USB1_D-	DIFF	
4	USB2_D-	DIFF	
5	USB1_D+	DIFF	
6	USB2_D+	DIFF	
7	GND	GND	GND
8	GND	GND	GND
9	GND	GND	GND
10	GND	GND	GND

2.5 Function Block

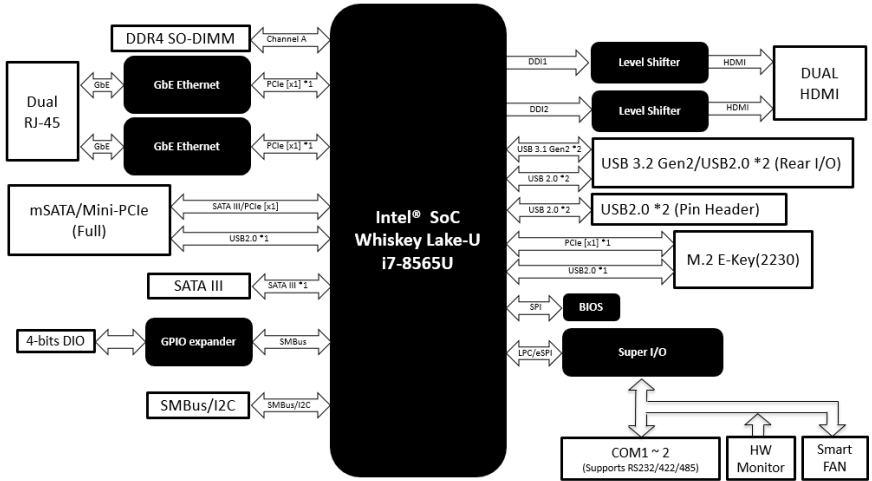

Chapter 3

AMI BIOS Setup

3.1 System Test and Initialization

The PICO-WHU4-SEMI uses certain routines to perform testing and initialization during the boot up sequence. If an error, fatal or non-fatal, is encountered, the system will output a few short beeps or display an error message. The board can usually continue the boot up sequence with non-fatal errors.

The system configuration verification routines check the current system configuration against the values stored in the CMOS memory and BIOS NVRAM. If a system configuration is not found or an error is detected, the system will load the default configuration and reboot automatically.

There are four situations in which you will need to setup system configuration:

1. You are starting your system for the first time
2. You have changed the hardware attached to your system
3. The system configuration was reset by the Clear-CMOS jumper
4. The CMOS memory has lost power and the configuration information has been erased.

The PICO-WHU4-SEMI CMOS memory has an integrated lithium battery backup for data retention. The battery must be replaced when it runs down.

3.2 AMI BIOS Setup

The AMI BIOS ROM has a pre-installed Setup program that allows users to modify basic system configurations. These configurations are stored in the battery-backed CMOS RAM and BIOS NVRAM so the information is retained when power is turned off.

To enter BIOS Setup, turn on the system and immediately press or <ESC>.

The following BIOS menus and their functions are listed below.

Main: Set the date, use tab to switch between date elements.

Advanced: Enable/ disable boot options for legacy network devices.

Chipset: Host bridge parameters.

Security: Set setup administrator password.

Boot: Enable/ disable quiet boot option.

Save & Exit: Exit system setup after saving the changes.

3.3 Setup Submenu: Main

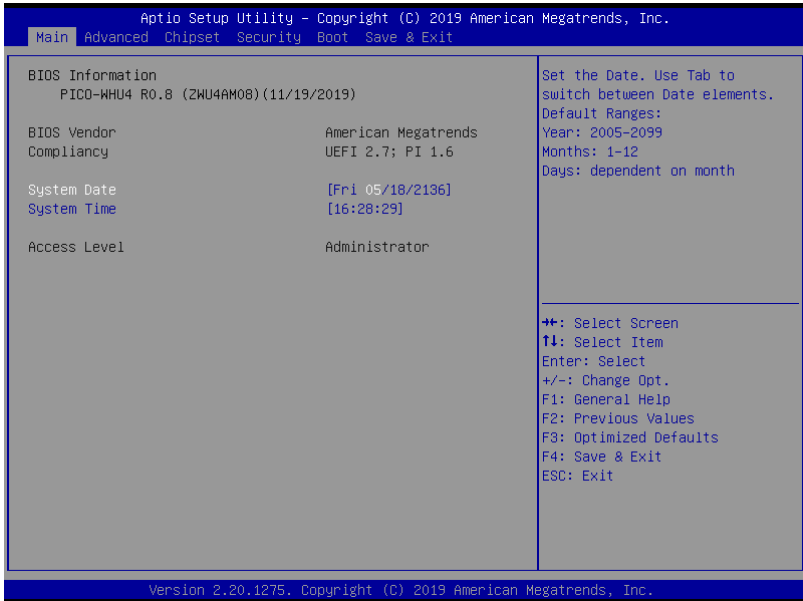

3.4 Setup Submenu: Advanced

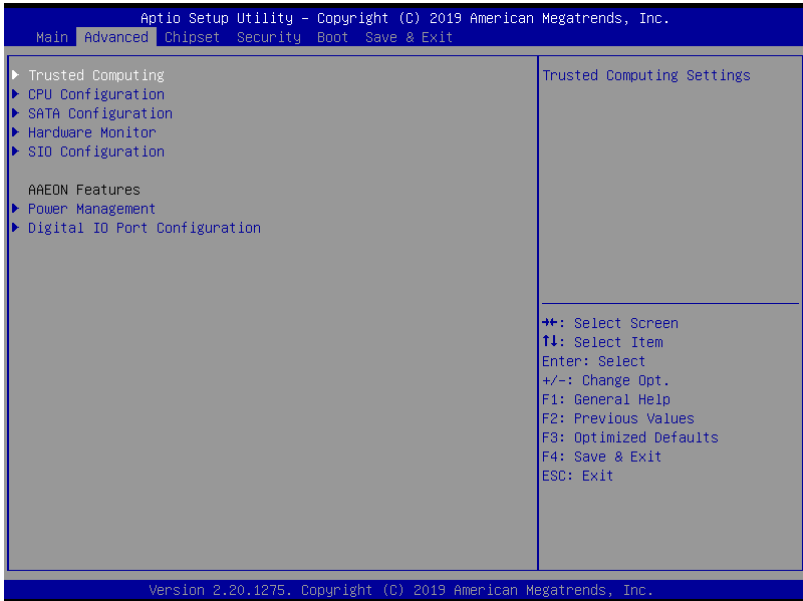

3.4.1 Trusted Computing

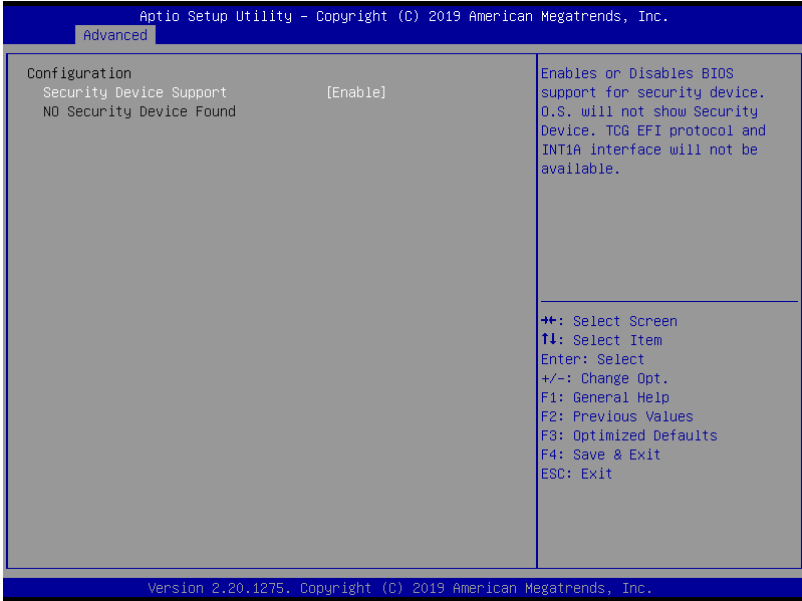

Options Summary		
Security Device Support	Disable	Optimal Default, Failsafe Default
	Enable	
Enables or Disables BIOS support for security device. O.S. will not show Security Device. TCG EFI protocol and INT1A interface will not be available.		
SHA-1 PCR Bank	Disable	Optimal Default, Failsafe Default
	Enable	
Enable or Disable SHA-1 PCR Bank		
SHA256 PCR Bank	Disable	Optimal Default, Failsafe Default
	Enable	
Enable or Disable SHA256 PCR Bank		
Pending Operation	None	Optimal Default, Failsafe Default
	TPM Clear	
Schedule an Operation for the Security Device. NOTE: Your Computer will reboot during restart in order to change State of Security Device.		

Options Summary		
Platform Hierarchy	Disabled	Optimal Default, Failsafe Default
	Enabled	
Enable or disable Platform Hierarchy		
Storage Hierarchy	Disabled	Optimal Default, Failsafe Default
	Enabled	
Enable or Disable Storage Hierarchy		
Endorsement Hierarchy	Disabled	Optimal Default, Failsafe Default
	Enabled	
Enable or Disable Endorsement Hierarchy		
TPM2.0 UEFI Spec Version	TCG_1_2	Optimal Default, Failsafe Default
	TCG_2	
Select the TCG2 Spec Version Support, TCG_1_2: Compatible mode for Win8/Win10 TCG_2: Support new TCG2 protocol and event format for Win10 or later		
Physical Presence Spec Version	1.2	Optimal Default, Failsafe Default
	1.3	
Select to Tell O.S. to support PPI Spec Version 1.2 or 1.3. Note some HCK tests might not support 1.3.		

3.4.2 CPU Configuration

Aprio Setup Utility - Copyright (C) 2019 American Megatrends, Inc.

Advanced

CPU Configuration		Number of cores to enable in each processor package.
Type	Intel(R) Celeron(R) CPU 4305UE @ 2.00GHz	
ID	0x806EC	
Microcode Revision	D6	
Speed	2000 MHz	
L1 Data Cache	32 KB x 2	
L1 Instruction Cache	32 KB x 2	
L2 Cache	256 KB x 2	
L3 Cache	2 MB	
L4 Cache	N/A	
VMX	Supported	
SMX/TXT	Not Supported	
Active Processor Cores	[All]	
Intel (VMX) Virtualization Technology	[Enabled]	
C states	[Enabled]	
Intel(R) SpeedStep(tm)	[Enabled]	

Version 2.20.1275. Copyright (C) 2019 American Megatrends, Inc.

Options Summary

Active Processor Cores	All	Optimal Default, Failsafe Default
	1	
Number of cores to enable in each processor package.		
Intel (VMX) Virtualization Technology	Disabled	Optimal Default, Failsafe Default
	Enabled	
When enabled, a VMM can utilize the additional hardware capabilities provided by Vanderpool Technology.		
C-States	Disabled	Optimal Default, Failsafe Default
	Enabled	
Enable/Disable C States.		
EIST™	Disabled	Optimal Default, Failsafe Default
	Enabled	
Enable/Disable Intel SpeedStep.		
Intel(R) SpeedStep(tm)	Disabled	Optimal Default, Failsafe Default
	Enabled	
Allows more than two frequency ranges to be supported.		

3.4.3 SATA Configuration

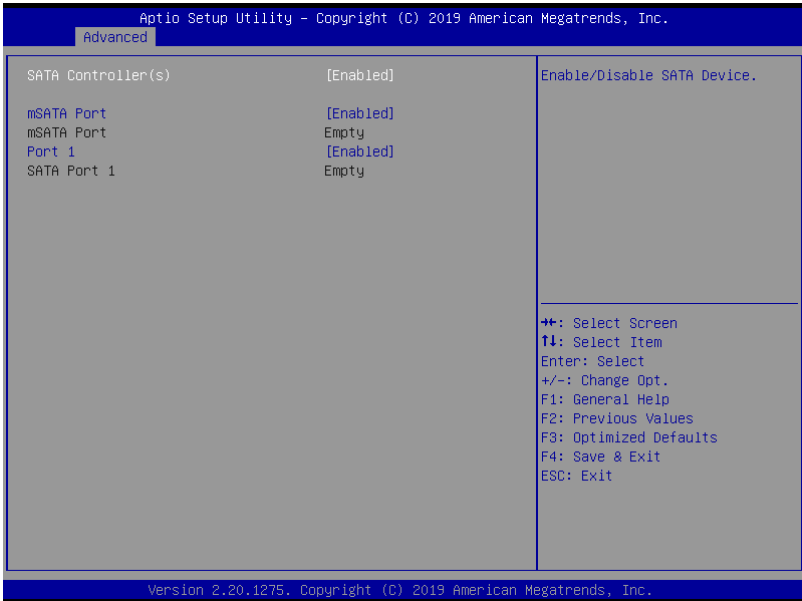

Options Summary		
SATA Controller(s)	Disabled	Optimal Default, Failsafe Default
	Enabled	
Enable/Disable SATA Device.		
mSATA port	Disabled	Optimal Default, Failsafe Default
	Enabled	
Enable or Disable SATA Port		
Port 1	Disabled	Optimal Default, Failsafe Default
	Enabled	
Enable or Disable SATA Port		

3.4.4 Hardware Monitor

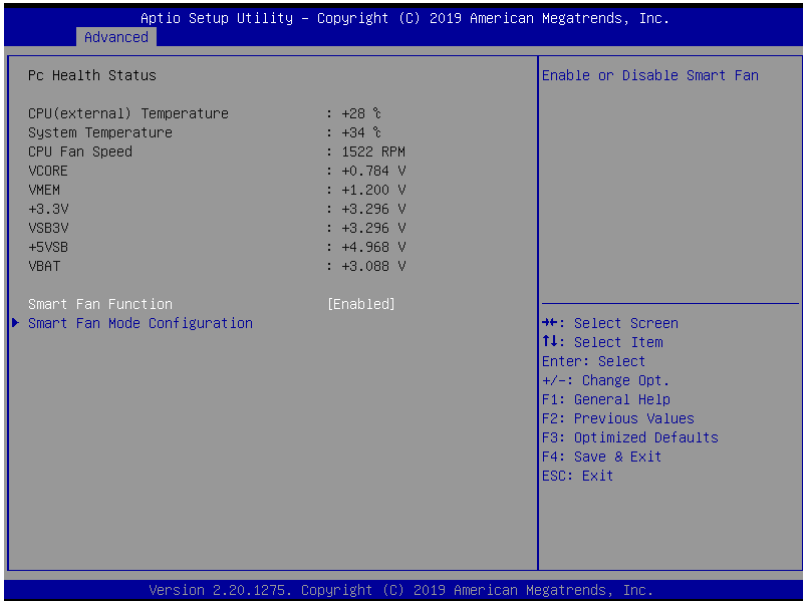

3.4.4.1 Smart Fan Mode Configuration

Auto Duty-Cycle Mode

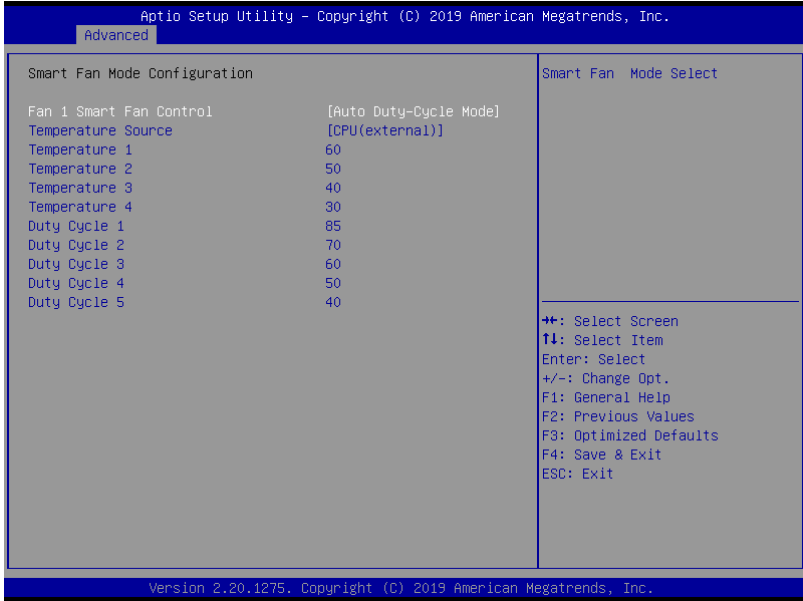

Options Summary		
Fan Mode	Auto RPM Mode	
	Auto Duty-Cycle Mode	Optimal Default, Failsafe Default
Smart Fan Mode Select		
Temperature Source	CPU	
	CPU (external)	Optimal Default, Failsafe Default
	System	
Select the monitored temperature source for this fan.		
Temperature	Auto fan speed control. Fan speed will follow different temperature by different duty cycle 1-100	
Duty Cycle		

Auto RPM Mode

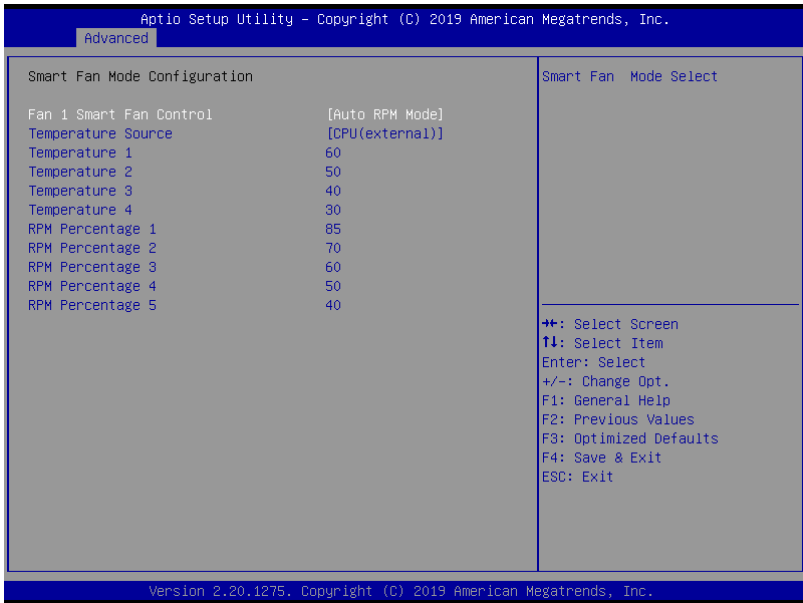

Options Summary

Temperature	Auto fan speed control. Fan speed will follow different
RPM Percentage	temperature by different RPM 1-100

Manual Duty

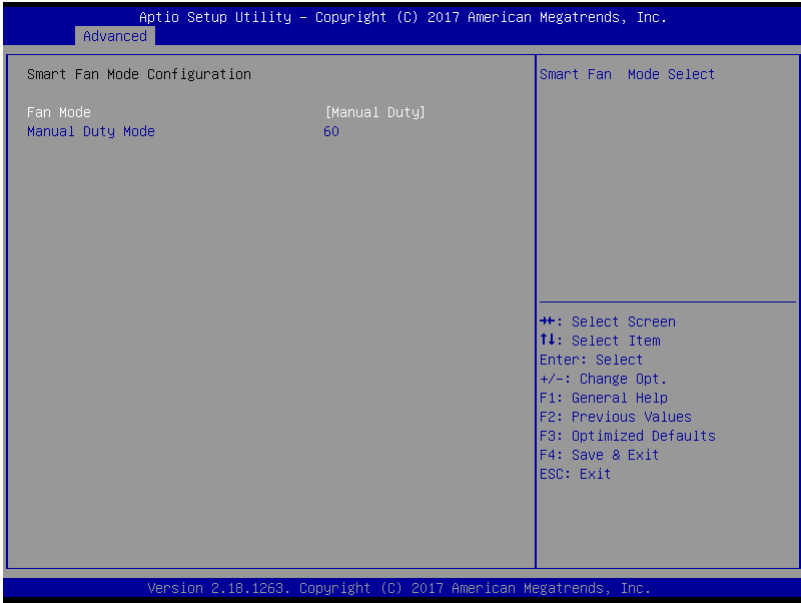

Options Summary		
Manual Duty Mode	60	Optimal Default, Failsafe Default
Manual mode fan control, user can write expected duty cycle (PWM fan type) 1-100		

Manual RPM Mode

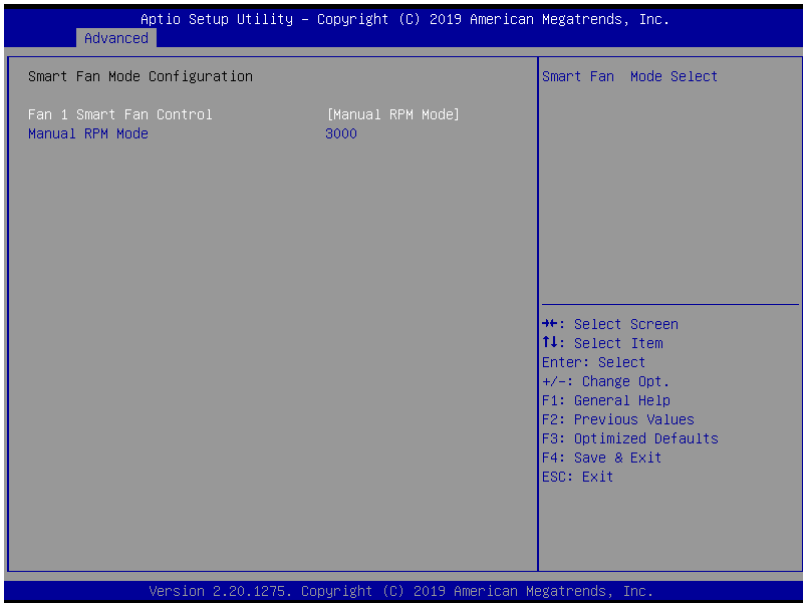

Options Summary		
Manual RPM Mode	3000	Optimal Default, Failsafe Default
Manual mode fan control, user can write expected RPM count 500-10000		

3.4.5 SIO Configuration



3.4.5.1 Serial Port 1 Configuration

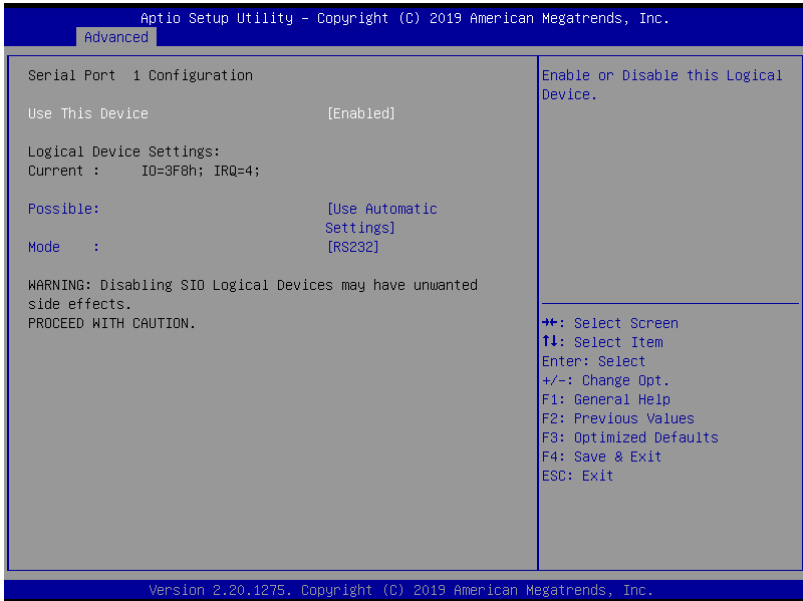

Options Summary		
Use This Device	Disable	Optimal Default, Failsafe Default
	Enable	
Enable or Disable this Logical Device.		
Possible:	Use Automatic Settings	Optimal Default, Failsafe Default
	IO=3F8h; IRQ=4	
	IO=2F8h; IRQ=3	
Allows user to change Device's Resource settings. New settings will be reflected on This Setup Page after System restarts.		
Mode	RS232	Optimal Default, Failsafe Default
	RS422	
	RS485	
UART RS232, 422, 485 selection		

3.4.5.2 Serial Port 2 Configuration

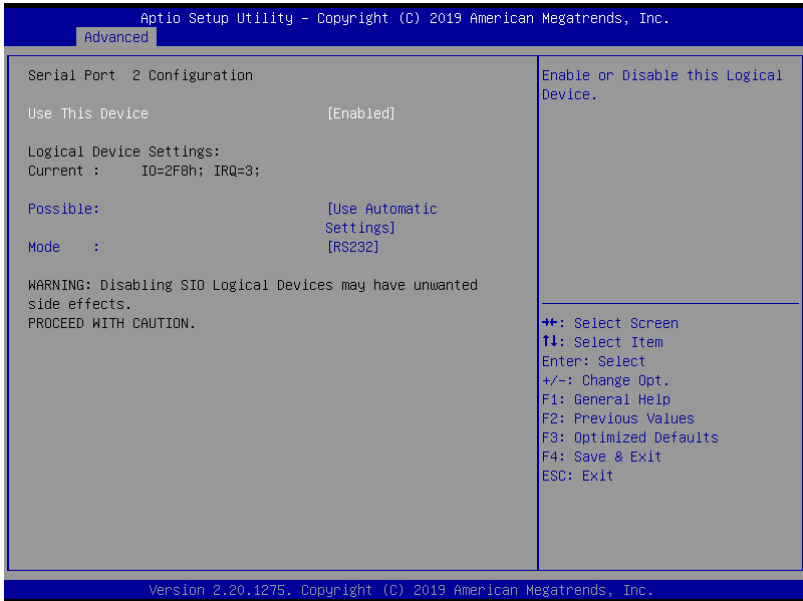

Options Summary		
Use This Device	Disable	Optimal Default, Failsafe Default
	Enable	
Enable or Disable this Logical Device.		
Possible:	Use Automatic Settings	Optimal Default, Failsafe Default
	IO=2F8h; IRQ=3	
	IO=3F8h; IRQ=4	
Allows user to change Device's Resource settings. New settings will be reflected on This Setup Page after System restarts.		
Mode	RS232	Optimal Default, Failsafe Default
	RS422	
	RS485	
UART RS232, 422, 485 selection		

3.4.6 Power management

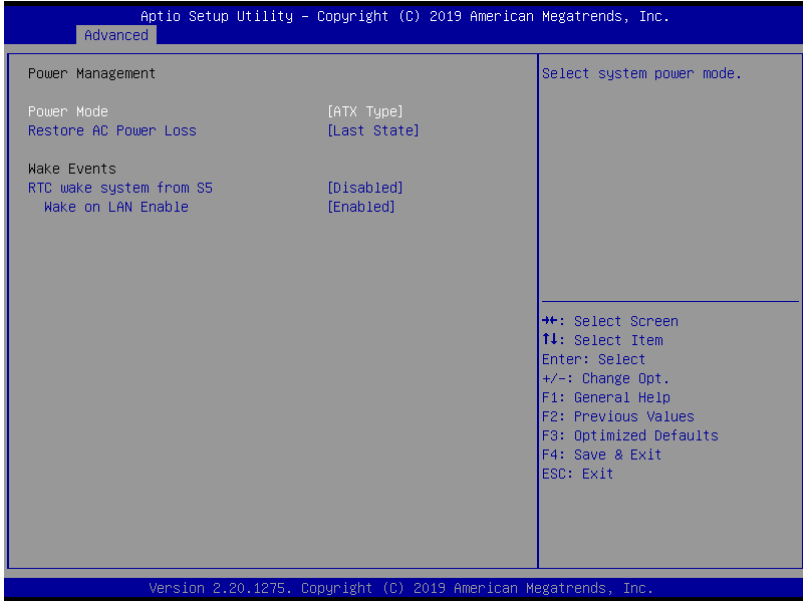

Options Summary		
Power Mode	ATX Type	Optimal Default, Failsafe Default
	AT Type	
Select system power mode		
Restore AC Power Loss	Last State	Optimal Default, Failsafe Default
	Always On	
	Always Off	
IO Restore AC power Loss		
RTC wake system from S5	Disable	Optimal Default, Failsafe Default
	Fixed Time	
	Dynamic Time	
Fixed Time: System will wake on the hr::min::sec specified./n Dynamic Time: System will wake on the current time + Increase minute(s)		
Wake on LAN Enable	Enabled	Optimal Default, Failsafe Default
	Disabled	
Enable/Disable integrated LAN to wake the system.		

3.4.7 Digital IO Port Configuration

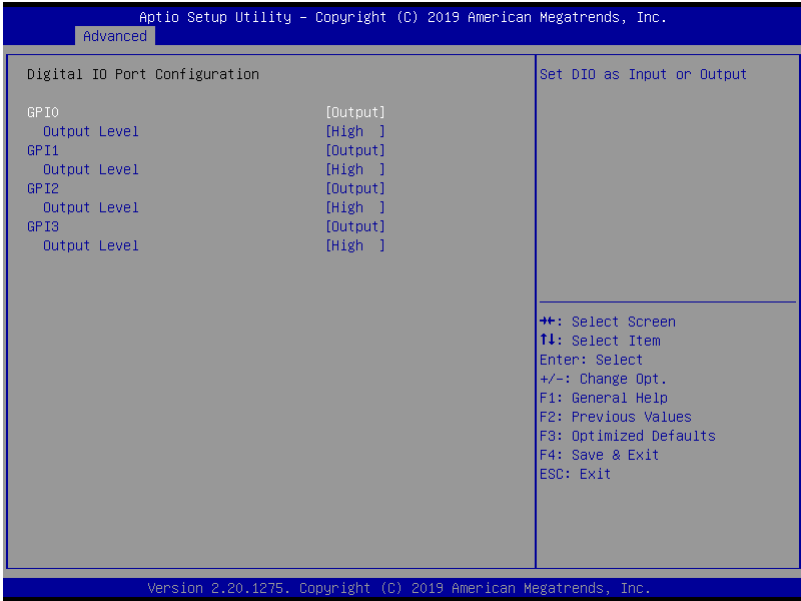

Options Summary		
DIO Port*	Output	
	Input	
Set DIO as Input or Output		
Output Level	High	Optimal Default, Failsafe Default
	Low	
Set output level when DIO pin is output		

3.5 Setup Submenu: Chipset

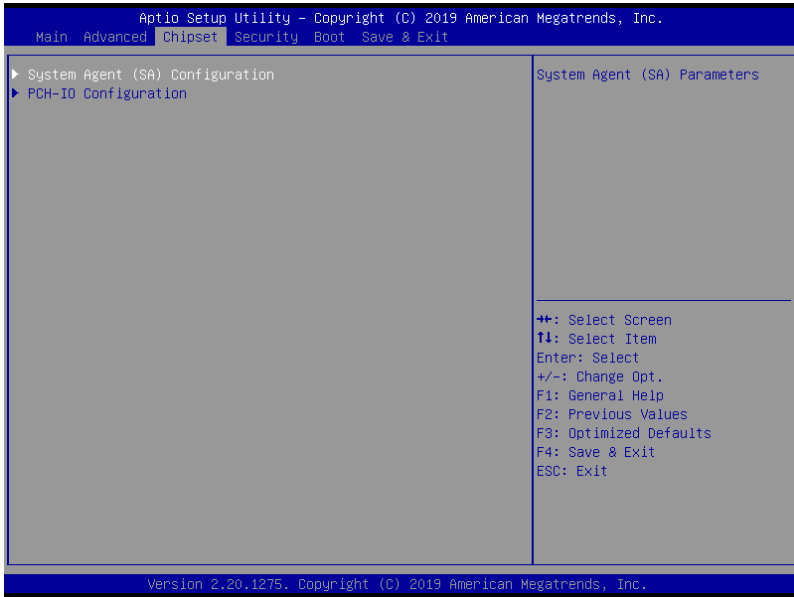

3.5.1 System Agent (SA) Configuration

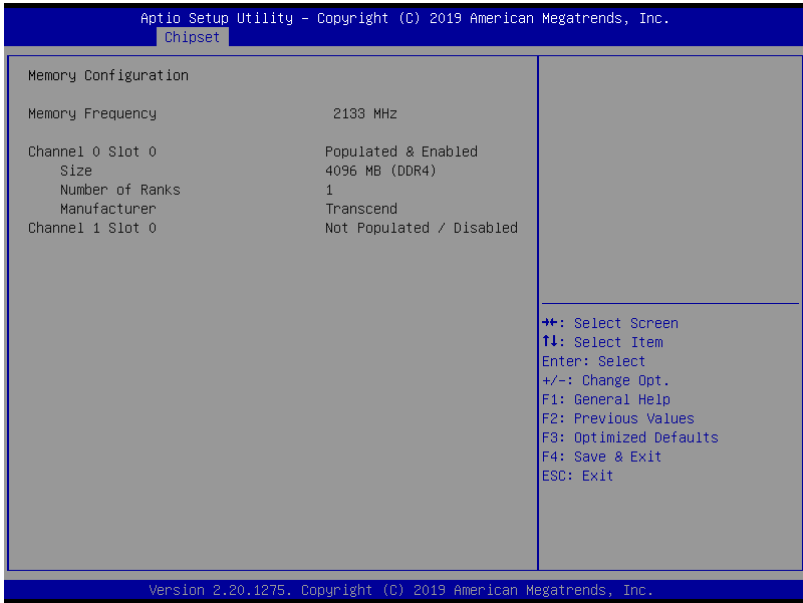

3.5.2 PCH-IO Configuration

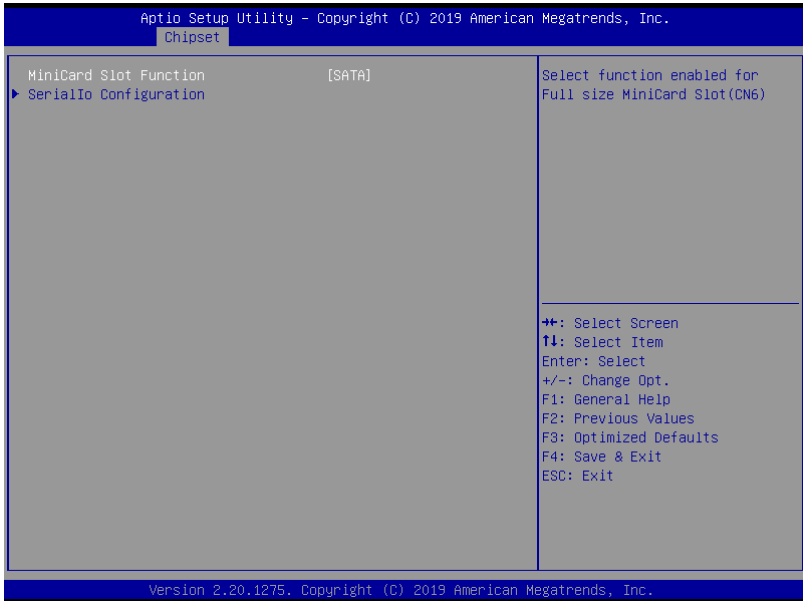

Options Summary		
MiniCard Slot Function	SATA	Optimal Default, Failsafe Default
	PCIe	
Select function enabled for Full size MiniCard Slot (CN6)		

3.5.2.1 Serial IO Configuration

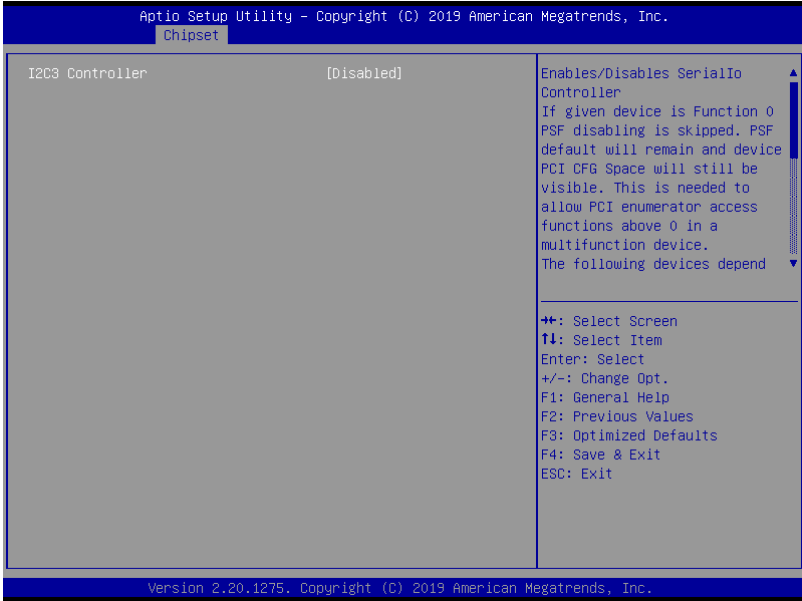

Options Summary		
I2C3 Controller	Disabled	Optimal Default, Failsafe Default
	Enabled	
Enables/ Disables Serial IO Controller		

3.6 Setup Submenu: Security

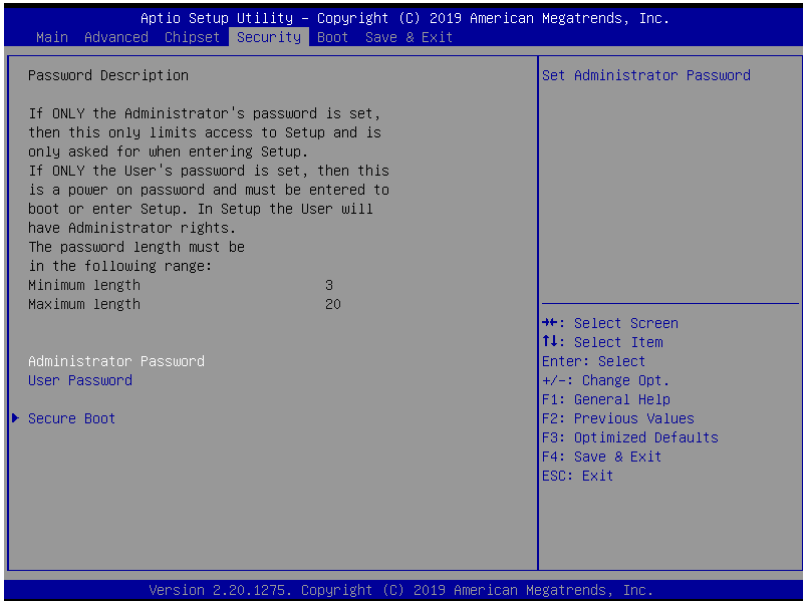

Change User/Administrator Password

You can set an Administrator Password or User Password. An Administrator Password must be set before you can set a User Password. The password will be required during boot up, or when the user enters the Setup utility. A User Password does not provide access to many of the features in the Setup utility.

Select the password you wish to set, and press Enter. In the dialog box, enter your password (must be between 3 and 20 letters or numbers). Press Enter and retype your password to confirm. Press Enter again to set the password.

Removing the Password

Select the password you want to remove and enter the current password. At the next dialog box press Enter to disable password protection.

3.6.1 Secure Boot

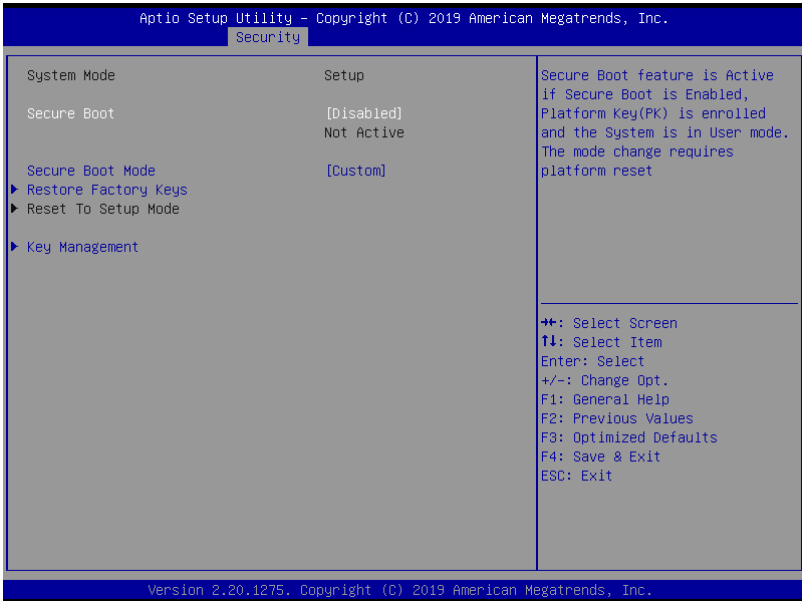

Options Summary		
Secure Boot	Disabled	Optimal Default, Failsafe Default
	Enabled	
Secure Boot feature is Active if Secure Boot is Enabled, Platform Key (PK) is enrolled and the System is in User mode. The mode change requires platform reset		
Secure Boot Mode	Custom	Optimal Default, Failsafe Default
	Standard	
Secure Boot mode options: Standard or Custom. In Custom mode, Secure Boot Policy variables can be configured by a physically present user without full authentication		
Restore Factory Keys		
Force System to User Mode. Install factory default Secure Boot key databases		
Reset To Setup Mode		
Delete all Secure Boot key databases from NVRAM		

3.6.1.1 Key Management

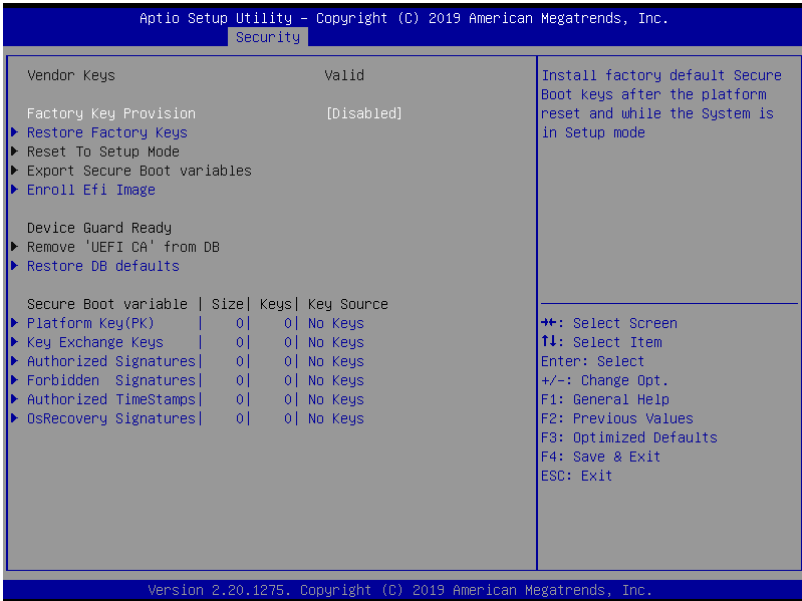

Options Summary		
Factory Key Provision	Disabled	Optimal Default, Failsafe Default
	Enabled	
Secure Boot feature is Active if Secure Boot is Enabled, Platform Key (PK) is enrolled and the System is in User mode. The mode change requires platform reset		
Restore Factory Keys		
Force System to User Mode. Install factory default Secure Boot key databases		
Reset To Setup Mode		
Delete all Secure Boot key databases from NVRAM		
Export Secure Boot variables		
Copy NVRAM content of Secure Boot variables to files in a root folder on a file system device		
Enroll Efi Image		
Allow the image to run in Secure Boot mode. Enroll SHA256 Hash certificate of a PE image into Authorized Signature Database (db)		

Options Summary		
Remove 'UEFI CA' from DB		
Device Guard ready system must not list 'Microsoft UEFI CA' Certificate in Authorized Signature database (db)		
Restore DB defaults		
Restore DB variable to factory defaults		
Platform Key (PK)	Details	
	Export	
	Update	
	Delete	
Key Exchange Keys	Details	
	Export	
	Update	
	Append	
	Delete	
Authorized Signatures	Details	
	Export	
	Update	
	Append	
	Delete	
Forbidden Signatures	Details	
	Export	
	Update	
	Append	
	Delete	
Authorized TimeStamps	Update	
	Append	
OsRecovery Signatures	Update	
	Append	
Enroll Factory Defaults or load certificates from a file: 1.Public Key Certificate: a) EFI_SIGNATURE_LIST b) EFI_CERT_X509 (DER) c) EFI_CERT_RSA2048 (bin) d)EFI_CERT_SHAXXX 2.Authenticated UEFI Variable 3.EFI PE/COFF Image (SHA256) Key Source: Factory,External,Mixed		

3.7 Setup submenu: Boot

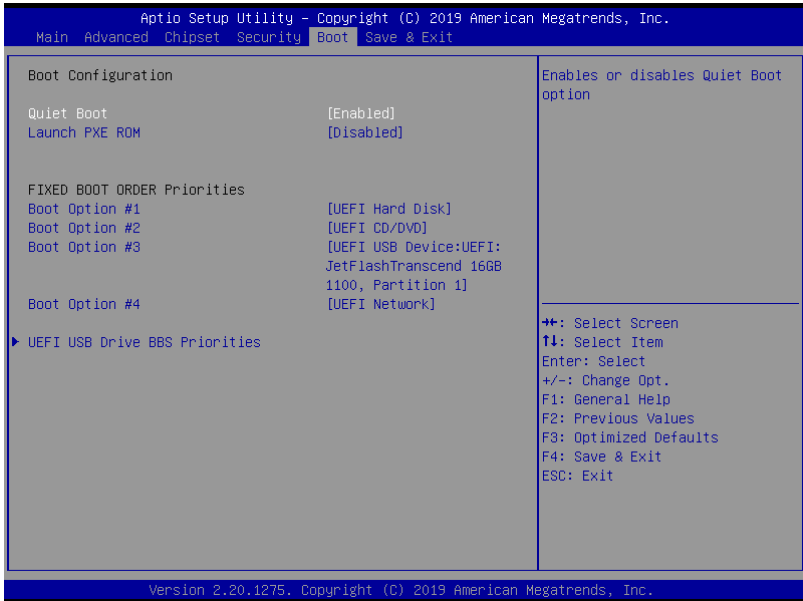

Options Summary		
Quiet Boot	Disabled	Optimal Default, Failsafe Default
	Enabled	
Enable or disable showing boot logo.		
Lunch PXE ROM	Disabled	Optimal Default, Failsafe Default
	Enabled	
Controls the execution of UEFI and Legacy Network OpROM		

3.7.1 BBS Priorities

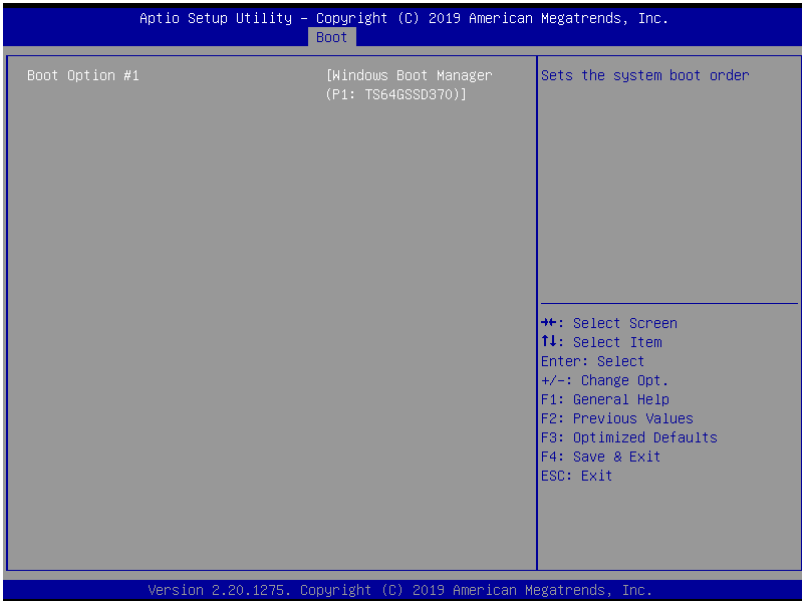

3.8 Setup submenu: Exit

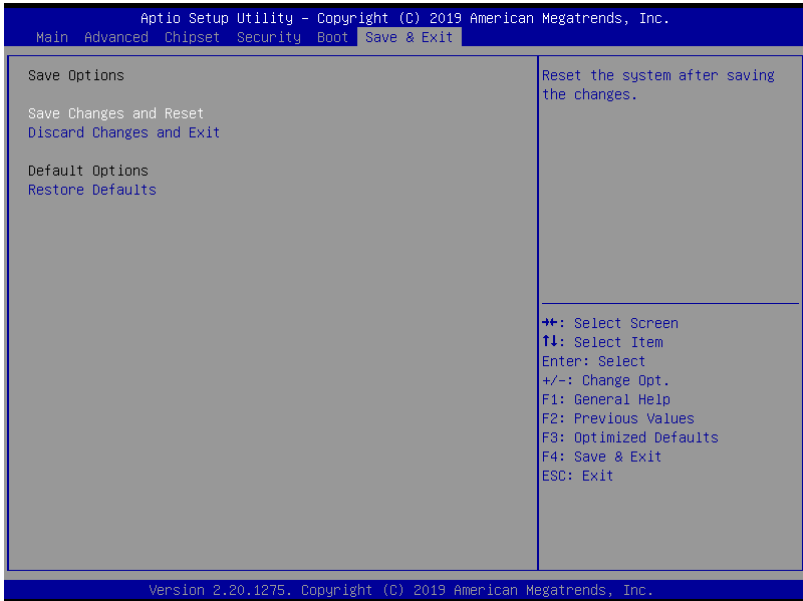

Chapter 4

Drivers Installation

4.1 Drivers Download and Installation

Drivers for the PICO-WHU4-SEMI can be downloaded from the product page on the AAEON website by following this link:

<https://www.aaeon.com/en/p/pico-itx-boards-pico-WHU4-SEMI>

Download the driver(s) you need and follow the steps below to install them.

Step 1 – Install Chipset Driver

1. Open the **Step 1 – Intel Chipset** folder and select your OS.
2. Open the **SetupChipset.exe** file.
3. Follow the instructions
4. Drivers will be installed automatically

Step 2 – Install Graphics Driver

1. Open the **Step 2 – Intel Graphics** folder and select your OS.
2. Open the **igxpin.exe** file.
3. Follow the instructions
4. Driver will be installed automatically

Step 3 – Install Management Engine Driver

1. Open the **Step 3 – Intel Management Engine** folder and select your OS
2. Open the **MEISetup.exe** file in the folder
3. Follow the instructions
4. Driver will be installed automatically

Step 4 – Install Serial IO Driver

1. Open the **Step 4 – Intel Serial IO** folder and select your OS
2. Open the **SetupSerialIO.exe** file
3. Follow the instructions
4. Driver will be installed automatically

Step 5 – Install LAN Driver

1. Open the **Step 5 – LAN** folder and select your OS
2. Open the **setup.exe** file
3. Follow the instructions
4. Driver will be installed automatically

Appendix A

Mating Connectors

A.1 List of Mating Connectors and Cables

The following table lists mating connectors and available cables.

Connector Label	Function	Mating Connector		Available Cable	Cable P/N
		Vendor	Model no		
CN1	LPC Port	JST	SHR-12V-S-B	LPC Port Cable	1703120130
CN2	COM Port 1/2 Connector	JST	SHDR-20V-S-B	COM Port Cable	1701200102
CN3	Front Panel Connector	ACES	50248-010H0H0-001	Front Panel Cable	NA
CN7	SATA Port	Molex	887505318	NA	NA
CN8	LAN Connector	Molex	44915-0001	NA	NA
CN9	+5V Output for SATA HDD	JST	PHR-2	SATA power Cable	1702150155
CN10	HDMI	Molex	88768-9900	NA	NA
CN11	USB 3.0 Connector	Würth Electronics	710-692112030100	NA	NA
CN12	External +12V Input	Molex	19211-0003	Power Cable	170204010R
CN13	DC Jack (Optional)	HUANG JI	5525C257-3T00-R1-7.5	Power Cable	1702041004
CN15	FAN Connector	Molex	51021-0400	NA	NA
CN17	Battery	Molex	51021-0200	Battery Cable	175011301C
CN18	Digital IO Port	Molex	78120-0607	NA	NA
CN19	USB 2.0 Connector	JCTC	11002H00-2x5P	USB Cable	170010010D