

Data sheet | Item number: 2606-1104/020-004

PCB terminal block; lever; 6 mm²; Pin spacing 7.5 mm; 4-pole; Push-in CAGE

CLAMP®; 6,00 mm²; black



www.wago.com/2606-1104/020-004

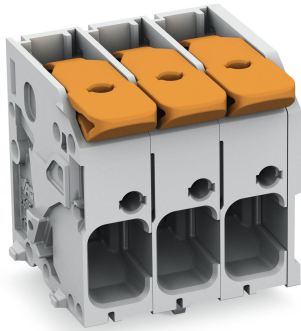

 Picture differs from the item.

RoHS  Compliant



Color: 

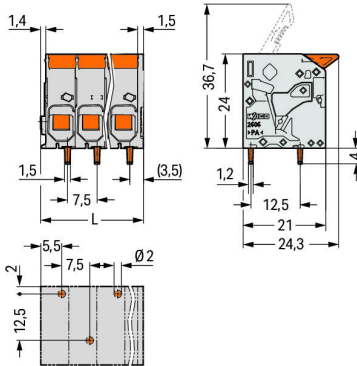
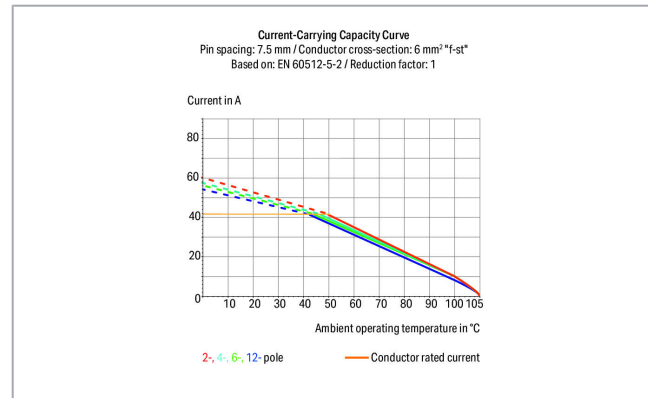

$$L = (\text{pole no.} - 1) \times \text{pin spacing} + 10.35 \text{ mm}$$

Item description

- PCB terminal blocks with levers and Push-in CAGE CLAMP® connection
- Push-in termination of solid and ferruled conductors
- Intuitive and tool-free operation

Subject to changes. Please also observe the further product documentation!

WAGO Kontakttechnik GmbH & Co. KG

Hansastr. 27

32423 Minden

Phone: +49571 887-0 | Fax: +49571 887-169

Email: info.de@wago.com | Web: www.wago.com

Do you have any questions about our products?

We are always happy to take your call at +49 (571) 887-44222.



- Several clamping units can be held open simultaneously – convenient for terminating multi-core cables
- Testing can be performed both parallel and perpendicular to conductor entry

Data

Electrical data

Ratings per IEC/EN

Ratings per	IEC/EN 60664-1
Nominal voltage (III/3)	800 V
Rated surge voltage (III/3)	8 kV
Rated voltage (III/2)	1000 V
Rated surge voltage (III/2)	8 kV
Nominal voltage (II/2)	1000 V
Rated surge voltage (II/2)	8 kV
Rated current	41 A
Legend (ratings)	(III / 2) $\hat{=}$ Overvoltage category III / Pollution degree 2

Ratings per UL

Approvals per	UL 1059
Rated voltage UL (Use Group B)	600 V
Rated current UL (Use Group B)	31 A
Rated voltage UL (Use Group C)	600 V
Rated current UL (Use Group C)	31 A

Ratings per CSA

Approvals per	CSA
Rated voltage CSA (Use Group B)	600 V
Rated current CSA (Use Group B)	31 A
Rated voltage CSA (Use Group C)	600 V
Rated current CSA (Use Group C)	31 A

Connection data

Connection technology	Push-in CAGE CLAMP®
Actuation type	Lever
Solid conductor	0.2 ... 10 mm ² / 24 ... 8 AWG
Fine-stranded conductor	0.2 ... 10 mm ² / 24 ... 8 AWG

Subject to changes. Please also observe the further product documentation!



Fine-stranded conductor; with insulated ferrule	0.25 ... 6 mm ²
Fine-stranded conductor; with uninsulated ferrule	0.25 ... 6 mm ²
Fine-stranded conductor; with twin ferrule	0.25 ... 2.5 mm ²
Strip length	11 ... 13 mm / 0.43 ... 0.51 inch
Conductor connection direction to PCB	0°
Pole No.	4
Total number of connection points	4
Total number of potentials	4
Number of connection types	1
Number of levels	1

Physical data

Pin spacing	7.5 mm / 0.295 inch
Width	32.85 mm / 1.293 inch
Height	28 mm / 1.102 inch
Height from the surface	24 mm / 0.945 inch
Depth	24.3 mm / 0.957 inch
Solder pin length	4 mm
Solder pin dimensions	1.5 x 1.2 mm
Drilled hole diameter with tolerance	2 ^(+0.1) mm

PCB contact

PCB Contact	THT
Solder pin arrangement	over the entire terminal strip (staggered)
Number of solder pins per potential	1

Material data

Color	black
Material group	I
Insulation material	Polyamide (PA66)
Flammability class per UL94	V0
Clamping spring material	Chrome nickel spring steel (CrNi)
Contact material	Electrolytic copper (E _{Cu})
Contact plating	tin-plated
Fire load	0.017 MJ
Color of actuator	orange

Subject to changes. Please also observe the further product documentation!

Weight	15.6 g
--------	--------

Environmental requirements







Limit temperature range	-60 ... +105 °C
-------------------------	-----------------

Commercial data

Packaging type	BOX
Country of origin	DE
GTIN	4055143639101
Customs tariff number	85369010000

Compatible products

ferrule

	Item no.: 216-108 Ferrule; Sleeve for 6 mm ² / AWG 10; uninsulated; electro-tin plated; silver-colored	www.wago.com/216-108
	Item no.: 216-208 Ferrule; Sleeve for 6 mm ² / AWG 10; insulated; electro-tin plated; electrolytic copper; gastight crimped; acc. to DIN 46228, Part 4/09.90; yellow	www.wago.com/216-208
	Item no.: 216-263 Ferrule; Sleeve for 1 mm ² / AWG 18; insulated; electro-tin plated; electrolytic copper; gastight crimped; acc. to DIN 46228, Part 4/09.90; red	www.wago.com/216-263
	Item no.: 216-264 Ferrule; Sleeve for 1.5 mm ² / AWG 16; insulated; electro-tin plated; electrolytic copper; gastight crimped; acc. to DIN 46228, Part 4/09.90; black	www.wago.com/216-264
	Item no.: 216-266 Ferrule; Sleeve for 2.5 mm ² / AWG 14; insulated; electro-tin plated; electrolytic copper; gastight crimped; acc. to DIN 46228, Part 4/09.90; blue	www.wago.com/216-266
	Item no.: 216-267 Ferrule; Sleeve for 4 mm ² / AWG 12; insulated; electro-tin plated; electrolytic copper; gastight crimped; acc. to DIN 46228, Part 4/09.90; gray	www.wago.com/216-267

Downloads

Documentation

Additional Information

Technical explanations	3. 4. 2019	pdf 2.0 MB	Download
------------------------	------------	---------------	----------

CAD/CAE-Data

PCB Design

Subject to changes. Please also observe the further product documentation!

WAGO Kontakttechnik GmbH & Co. KG
 Hansastr. 27
 32423 Minden
 Phone: +49571 887-0 | Fax: +49571 887-169
 Email: info.de@wago.com | Web: www.wago.com

Do you have any questions about our products?
 We are always happy to take your call at +49 (571) 887-44222.



[URL](#)

[Download](#)

Symbol and Footprint 2606-1104/020-004

CAX data for your PCB design, consisting of "schematic symbols and PCB footprints", allow easy integration of the WAGO component into your development environment.

Supported formats:

- Accel EDA 14 & 15
- Altium 6 to current version
- Cadence Allegro
- DesignSpark
- Eagle Libraries
- KiCad
- Mentor Graphics BoardStation
- Mentor Graphics Design Architect
- Mentor Graphics Design Expedition 99 and 2000
- OrCAD 9.X PCB and Capture
- PADS PowerPCB 3, 3.5, 4.X, and 5.X
- PADS PowerPCB and PowerLogic 3.0
- PCAD 2000, 2001, 2002, 2004, and 2006
- Pulsonix 8.5 or newer
- STL
- 3D STEP
- TARGET 3001!
- View Logic ViewDraw
- Quadcept
- Zuken CadStar 3 and 4
- Zuken CR-5000 and CR-8000

PCB Component Libraries (EDA), PCB CAD Library Ultra Librarian

Environmental Product Compliance

Compliance Search

Environmental Product Compliance 2606-1104/020-004

[URL](#)

[Download](#)

PCB terminal block; lever; 6 mm²; Pin spacing 7.5 mm; 4-pole; Push-in CAGE CLAMP®; 6,00 mm²; black

Subject to changes. Please also observe the further product documentation!

WAGO Kontakttechnik GmbH & Co. KG
Hansastr. 27
32423 Minden
Phone: +49571 887-0 | Fax: +49571 887-169
Email: info.de@wago.com | Web: www.wago.com

Do you have any questions about our products?
We are always happy to take your call at +49 (571) 887-44222.



Installation Notes

Subject to changes. Please also observe the further product documentation!

WAGO Kontakttechnik GmbH & Co. KG
Hansastr. 27
32423 Minden
Phone: +49571 887-0 | Fax: +49571 887-169
Email: info.de@wago.com | Web: www.wago.com

Do you have any questions about our products?
We are always happy to take your call at +49 (571) 887-44222.