

 Picture differs from the item.

RoHS  Compliant



Color: 

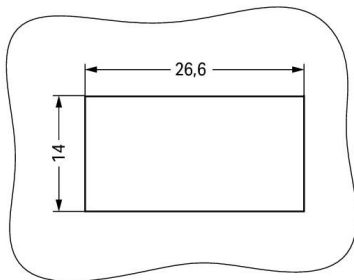

Plate thickness: 0.5 ... 2 mm
Cutout tolerance: + 0.1 mm

Item description

- Protected against mismatching and maintenance-free
- Push-in CAGE CLAMP® spring pressure connection technology allows solid conductors to be simply pushed into a unit.
- Low profile with 4.4 mm pole spacing
- Components can be clearly printed on and color-coded to meet custom requirements.
- When assembled, the installation connectors comply with IP40 and are suitable for easily accessible areas.

Subject to changes. Please also observe the further product documentation!

Data

Electrical data

Note on contact resistance	approx. 1 mΩ of contact resistance approx. 0.25 mΩ contact transition plug/socket
----------------------------	---

Ratings per IEC/EN

Ratings per	IEC/EN 60664-1
Nominal voltage (III/3)	400 V
Rated surge voltage (III/3)	6 kV
Rated current	16 A
Note on rated current	13 A for 3-pole load 10 A for 4-pole load
Legend (ratings)	(III / 3) ≙ Overvoltage category III / Pollution degree 3

Ratings per UL

Hinweis für den amerikanischen Markt	Application note for the U.S. market (USR): Some versions may also be used for current interruption in accordance with the UL certificate in select applications with currents below 5 A and voltages up to 600 V. For further information, please contact your local sales office.
Rated voltage UL 1977	600 V
Rated current UL 1977	12 A

Connection data

Connection technology	Push-in CAGE CLAMP®
Actuation type	Operating tool Push-in
Nominal cross-section	1.5 mm ²
Solid conductor	0.25 ... 1.5 mm ² / 22 ... 16 AWG
Solid conductor; push-in termination	0.75 ... 1.5 mm ² / 20 ... 16 AWG
Stranded conductor	0.25 ... 1 mm ² / 22 ... 18 AWG
Fine-stranded conductor	0.25 ... 1.5 mm ² / 22 ... 16 AWG
Fine-stranded conductor; with insulated ferrule	0.25 ... 0.75 mm ² / 22 ... 20 AWG
Fine-stranded conductor; with uninsulated ferrule	0.25 ... 0.75 mm ² / 22 ... 20 AWG
Fine-stranded conductor; with ferrule; push-in termination	0.75 mm ² / 20 AWG
Strip length	9 mm / 0.35 inch
Note (strip length)	see also packaging or instructions

Subject to changes. Please also observe the further product documentation!



Pole No.	4
Total number of connection points	4
Total number of potentials	4
Conductor entry direction to mating direction	0°

Physical data

Pin spacing	4.4 mm / 0.173 inch
Width	28.6 mm / 1.126 inch
Height	16 mm / 0.63 inch
Depth	39.8 mm / 1.567 inch

Mechanical data

Application	Measurement and regulation technology
Coding	B
Marking	3 2 1
Potential marking	3 PE 2 1
Mating force of a plug-in connection	approx. 20 ... 70 N (depending on pole number)
Retention force of a plug-in connection	Locked: > 80 N
Unmating force of a plug-in connection	Unlocked: approx. 20 ... 70 N (depending on pole number)
Number of mating cycles	200, without resistive load
Housing sheet thickness	0.5 ... 2 mm / 0.02 ... 0.079 inch
Mounting type	Snap-in
Protection type	IP20
Note on protection type	IP40 when mated

Plug-in connection

Contact type (pluggable connector)	Male connector/plug
Connector (connection type)	for conductor
Mismating protection	Yes
Note on mismating protection	All WINSTA [®] components are 100% protected against mismating when: a.) plugging different numbers of poles b.) plugging while rotated 180 c.) plugging while laterally staggered d.) plugging one pole
Locking lever	yes
Locking of plug-in connection	locking lever
Hinweis zur Verriegelung	All connectors for mounted installations (snap-in versions for lighting fixtures or devices, all types of PCB and distribution connectors) are factory-equipped with locking levers to ensure

Subject to changes. Please also observe the further product documentation!



plugs and sockets are securely locked. Additional locking levers are only required for flying leads (plug/socket).

Material data

Color	gray
Insulation material	Polyamide (PA66)
Clamping spring material	Chrome nickel spring steel (CrNi)
Contact material	Copper or copper alloy (surface-treated)
Fire load	0.167 MJ
Weight	6.9 g

Environmental requirements

Processing temperature	-5 ... +40 °C
Continuous operating temperature	-35 ... +85 °C
Note on continuous operating temperature	Insulating parts for temperatures \leq 105 °C

Commercial data

Packaging type	BOX
Country of origin	PL
GTIN	4055143427999
Customs tariff number	85366990990

Approvals / Certificates

Country specific Approvals

Logo	Approval	Additional Approval Text	Certificate name
	CB DEKRA Certification B.V.	EN 61984	71- 112993
	CB DEKRA Certification B.V.	IEC 61984	NL-64351

Ship Approvals

Logo	Approval	Additional Approval Text	Certificate name
	LR Lloyds Register	EN 61535	08/20047 (E2)

Subject to changes. Please also observe the further product documentation!



Counterpart



Item no.890-244/062-000

Socket; 4-pole; Cod. B; 1,50 mm²; gray

www.wago.com/890-244/062-000

Required accessories

tools



Item no.: 890-384

Operating tool; 4-way; green

www.wago.com/890-384

protection



Item no.: 890-644

Lockout cap; 4-pole; for cutouts; Plastic; black

www.wago.com/890-644



Item no.: 890-694

Lockout cap; 4-pole; for cutouts; Plastic; white

www.wago.com/890-694

Compatible products

tools



Item no.: 210-719

Operating tool; Blade: 2.5 x 0.4 mm; with a partially insulated shaft

www.wago.com/210-719

Downloads

Documentation

Bid Text

890-754/062-000 X81 - Datei	19. 2. 2019	xml 3.0 kB	Download
890-754/062-000 doc - Datei	30. 11. 2018	doc 23.6 kB	Download

CAD/CAE-Data

CAD data

Subject to changes. Please also observe the further product documentation!

WAGO Kontakttechnik GmbH & Co. KG
Hansastr. 27
32423 Minden
Phone: +49571 887-0 | Fax: +49571 887-169
Email: info.de@wago.com | Web: www.wago.com

Do you have any questions about our products?
We are always happy to take your call at +49 (571) 887-44222.

2D/3D Models 890-754/062-000

[URL](#)

[Download](#)

CAE data

EPLAN Data Portal 890-754/062-000

[URL](#)

[Download](#)

WSCAD Universe 890-754/062-000

[URL](#)

[Download](#)

ZUKEN Portal 890-754/062-000

[URL](#)

[Download](#)

WSCAD Universe 890-754/062-000

[URL](#)

[Download](#)

EPLAN Data Portal 890-754/062-000

[URL](#)

[Download](#)

Environmental Product Compliance

Compliance Search

Environmental Product Compliance 890-754/062-000

[URL](#)

[Download](#)

Snap-in plug; 4-pole; Cod. B; 1,50 mm²; gray

Installation Notes

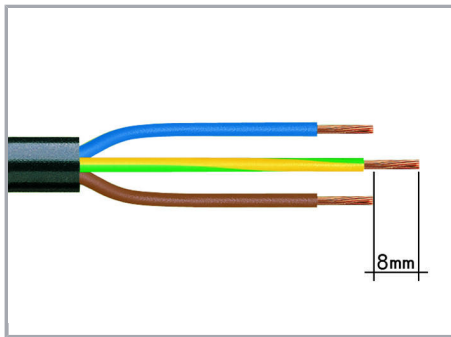

1. Strip length, outer insulation = 30 mm (2-pole), 37 mm (3-pole), 45 mm (4- and 5-pole)
2. Strip length = 9 mm
3. Extended ground conductor = 8 mm

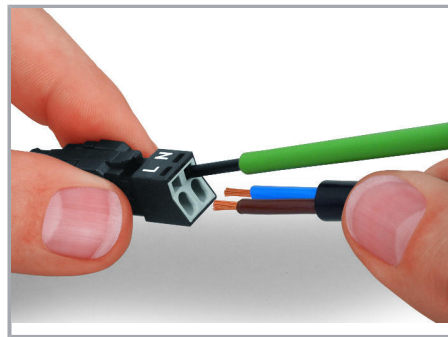

To terminate fine-stranded conductors, open the clamping unit via screwdriver – 2.5 mm blade width – and insert a stripped conductor until it hits the backstop. Terminate solid conductors by simply pushing them in.

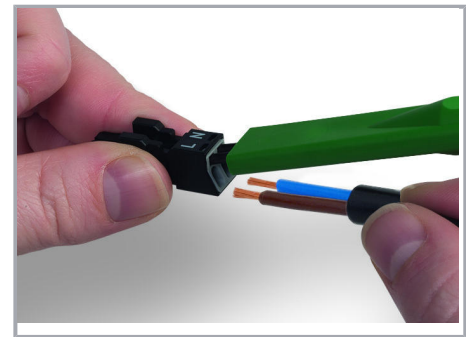

To terminate fine-stranded conductors, open clamping units via operating tool (890-382) and insert stripped conductors until they hit backstop.

Terminate solid conductors by simply pushing them in.

Subject to changes. Please also observe the further product documentation!

WAGO Kontakttechnik GmbH & Co. KG

Hansastr. 27

32423 Minden

Phone: +49571 887-0 | Fax: +49571 887-169

Email: info.de@wago.com | Web: www.wago.com

Do you have any questions about our products?

We are always happy to take your call at +49 (571) 887-44222.

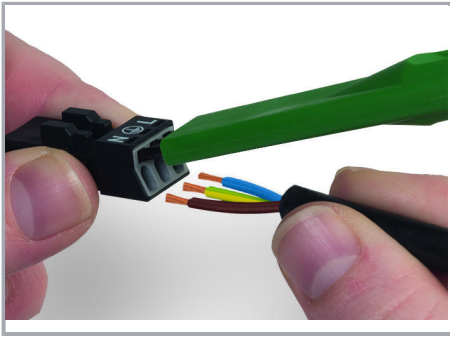

To terminate fine-stranded conductors, open clamping units via operating tool (890-383) and insert stripped conductors until they hit backstop.

Terminate solid conductors by simply pushing them in.

Mismatching protection

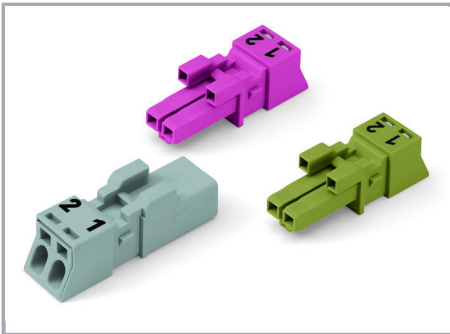

B-coded connectors with different colors can be plugged together.

Important note:

Different colors and/or pole markings are used for circuit identification. Only connectors of the same color and same pole marking must be plugged together.

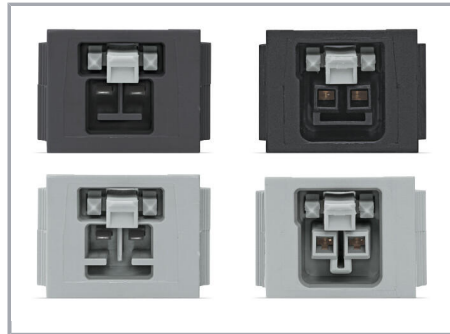

B-coded connectors (shown in gray) not only differ in color, but also in their design, making them incompatible with other coded connectors.



Product family

WINSTA® MINI

[Show all products from the family](#)

Subject to changes. Please also observe the further product documentation!