

Data sheet | Item number: 734-114/107-000

1-conductor female plug; 100% protected against mismating; Screw flange;
1.5 mm²; Pin spacing 3.5 mm; 14-pole; 1,50 mm²; light gray

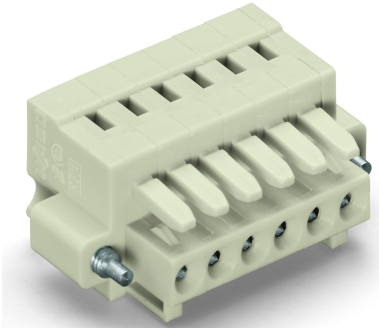

www.wago.com/734-114/107-000



 Picture differs from the item.

RoHS  Compliant



Color: 

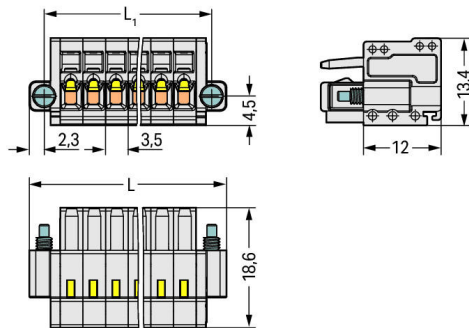
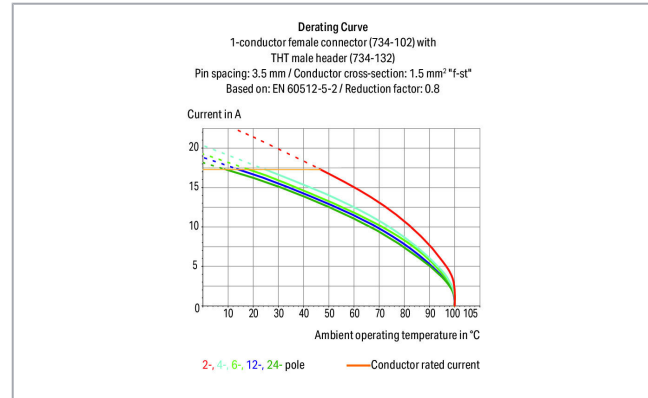

$$L = (\text{pole no.} \times \text{pin spacing}) + 9.5 \text{ mm}$$

$$L_1 = (\text{pole no.} \times \text{pin spacing}) + 4.9 \text{ mm}$$

Item description

- Universal connection for all conductor types

Subject to changes. Please also observe the further product documentation!

WAGO Kontakttechnik GmbH & Co. KG

Hansastr. 27

32423 Minden

Phone: +49571 887-0 | Fax: +49571 887-169

Email: info.de@wago.com | Web: www.wago.com

Do you have any questions about our products?

We are always happy to take your call at +49 (571) 887-44222.



- Easy cable pre-assembly and on-unit wiring via vertical and horizontal CAGE CLAMP® actuation
- Strain relief plates and housings for field assembly
- 100% protected against mismatching
- Coding option available

Safety information 1:

The MCS – MULTI CONNECTION SYSTEM includes connectors without breaking capacity in accordance with DIN EN 61984. When used as intended, these connectors must not be connected/disconnected when live or under load. The circuit design should ensure header pins, which can be touched, are not live when unmated.

Data**Electrical data****Ratings per IEC/EN**

| Ratings per | IEC/EN 60664-1 |
|-----------------------------|--|
| Nominal voltage (III/3) | 160 V |
| Rated surge voltage (III/3) | 2.5 kV |
| Rated voltage (III/2) | 160 V |
| Rated surge voltage (III/2) | 2.5 kV |
| Nominal voltage (II/2) | 320 V |
| Rated surge voltage (II/2) | 2.5 kV |
| Rated current | 10 A |
| Legend (ratings) | (III / 2) \triangleq Overvoltage category III / Pollution degree 2 |

Ratings per UL

| Approvals per | UL 1059 |
|--------------------------------|---------|
| Rated voltage UL (Use Group B) | 300 V |
| Rated current UL (Use Group B) | 10 A |
| Rated voltage UL (Use Group D) | 300 V |
| Rated current UL (Use Group D) | 10 A |

Ratings per CSA

| Approvals per | CSA |
|---------------------------------|-------|
| Rated voltage CSA (Use Group B) | 300 V |
| Rated current CSA (Use Group B) | 10 A |
| Rated voltage CSA (Use Group D) | 300 V |
| Rated current CSA (Use Group D) | 10 A |

Subject to changes. Please also observe the further product documentation!



Connection data

| | |
|---|--|
| Connection technology | CAGE CLAMP® |
| Actuation type | Operating tool |
| Solid conductor | 0.08 ... 1.5 mm ² / 28 ... 14 AWG |
| Fine-stranded conductor | 0.08 ... 1.5 mm ² / 28 ... 14 AWG |
| Fine-stranded conductor; with insulated ferrule | 0.25 ... 1.5 mm ² |
| Fine-stranded conductor; with uninsulated ferrule | 0.25 ... 1.5 mm ² |
| Note (conductor cross-section) | Terminating 1.5 mm ² conductors is possible; however insulation diameter does not allow clamping units to be terminated in a row. |
| Strip length | 6 ... 7 mm / 0.24 ... 0.28 inch |
| Pole No. | 14 |
| Total number of connection points | 14 |
| Total number of potentials | 14 |
| Number of connection types | 1 |
| Number of levels | 1 |
| Conductor entry direction to mating direction | 0° |

Physical data

| | |
|-------------|----------------------|
| Pin spacing | 3.5 mm / 0.138 inch |
| Width | 58.5 mm / 2.303 inch |
| Height | 13.4 mm / 0.528 inch |
| Depth | 18.6 mm / 0.732 inch |

Plug-in connection

| | |
|------------------------------------|-------------------------|
| Contact type (pluggable connector) | Female connector/socket |
| Connector (connection type) | for conductor |
| Mismating protection | Yes |
| Locking of plug-in connection | Screw flange |

Material data

| | |
|-----------------------------|-----------------------------------|
| Color | light gray |
| Material group | I |
| Insulation material | Polyamide (PA66) |
| Flammability class per UL94 | V0 |
| Clamping spring material | Chrome nickel spring steel (CrNi) |
| Contact material | Copper alloy |

Subject to changes. Please also observe the further product documentation!

| | |
|-----------------|------------|
| Contact plating | tin-plated |
| Fire load | 0.172 MJ |
| Weight | 12.1 g |

Environmental requirements



| | |
|-------------------------|-----------------|
| Limit temperature range | -60 ... +100 °C |
|-------------------------|-----------------|

Commercial data



| | |
|-----------------------|------------------------|
| Product Group | 3 (Multi Conn. System) |
| Packaging type | BOX |
| Country of origin | DE |
| GTIN | 4045454618995 |
| Customs tariff number | 85366990990 |

Approvals / Certificates

Country specific Approvals



| Logo | Approval | Additional Approval Text | Certificate name |
|--|--|--------------------------|------------------|
| | CB DEKRA Certification B.V. | EN 61984 | NL-54190 |
|  | CSA DEKRA Certification B.V. | C22.2 | 1465035 |
|  | KEMA/KEUR DEKRA Certification B.V. | EN 61984 | 71-105522 |

Ship Approvals

| Logo | Approval | Additional Approval Text | Certificate name |
|---|---|--------------------------|------------------|
|  | BV Bureau Veritas S.A. | IEC 60998 | 11915/DO BV |
|  | DNV GL Det Norske Veritas, Germanischer Lloyd | - | TAE000016Z |

Subject to changes. Please also observe the further product documentation!

UL-Approvals

| Logo | Approval | Additional Approval Text | Certificate name |
|--|--------------------------------------|--------------------------|------------------|
|  | UL UL International Germany GmbH | UL 1977 | 20150318-E45171 |
|  | UR Underwriters Laboratories Inc. | UL 1059 | E45172-19950922 |

Counterpart



Item no.734-144/108-000

THT male header; 1.0 x 1.0 mm solder pin; straight; 100% protected against mismating; Threaded flange; Pin spacing 3.5 mm; 14-pole; light gray

www.wago.com/734-144/108-000



Item no.734-174/108-000

THT male header; 1.0 x 1.0 mm solder pin; angled; 100% protected against mismating; Threaded flange; Pin spacing 3.5 mm; 14-pole; light gray

www.wago.com/734-174/108-000



Item no.734-314/109-000

1-conductor male connector; 100% protected against mismating; Threaded flange; 1.5 mm²; Pin spacing 3.5 mm; 14-pole; 1,50 mm²; light gray

www.wago.com/734-314/109-000

Compatible products

Strain relief plate



Item no.: 734-126

Strain relief plate; light gray

www.wago.com/734-126

ferrule



Item no.: 216-101

Ferrule; Sleeve for 0.5 mm² / AWG 22; uninsulated; electro-tin plated; silver-colored

www.wago.com/216-101



Item no.: 216-102

Ferrule; Sleeve for 0.75 mm² / AWG 20; uninsulated; electro-tin plated; silver-colored

www.wago.com/216-102



Item no.: 216-103

Ferrule; Sleeve for 1 mm² / AWG 18; uninsulated; electro-tin plated

www.wago.com/216-103



Item no.: 216-104

Ferrule; Sleeve for 1.5 mm² / AWG 16; uninsulated; electro-tin plated; silver-colored

www.wago.com/216-104

Subject to changes. Please also observe the further product documentation!

WAGO Kontakttechnik GmbH & Co. KG

Hansastr. 27

32423 Minden

Phone: +49571 887-0 | Fax: +49571 887-169

Email: info.de@wago.com | Web: www.wago.com

Do you have any questions about our products?









We are always happy to take your call at +49 (571) 887-44222.

| | | |
|--|---|--|
|  | Item no.: 216-121 Ferrule; Sleeve for 0.5 mm ² / AWG 22; uninsulated; electro-tin plated; silver-colored | www.wago.com/216-121 |
|  | Item no.: 216-122 Ferrule; Sleeve for 0.75 mm ² / AWG 20; uninsulated; electro-tin plated; silver-colored | www.wago.com/216-122 |
|  | Item no.: 216-123 Ferrule; Sleeve for 1 mm ² / AWG 18; uninsulated; electro-tin plated; silver-colored | www.wago.com/216-123 |
|  | Item no.: 216-124 Ferrule; Sleeve for 1.5 mm ² / AWG 16; uninsulated; electro-tin plated | www.wago.com/216-124 |
|  | Item no.: 216-131 Ferrule; Sleeve for 0.25 mm ² / AWG 24; uninsulated; electro-tin plated; silver-colored | www.wago.com/216-131 |
|  | Item no.: 216-132 Ferrule; Sleeve for 0.34 mm ² / AWG 24; uninsulated; electro-tin plated | www.wago.com/216-132 |
|  | Item no.: 216-141 Ferrule; Sleeve for 0.5 mm ² / 20 AWG; uninsulated; electro-tin plated; electrolytic copper; gastight crimped; acc. to DIN 46228, Part 1/08.92 | www.wago.com/216-141 |
|  | Item no.: 216-142 Ferrule; Sleeve for 0.75 mm ² / 18 AWG; uninsulated; electro-tin plated; electrolytic copper; gastight crimped; acc. to DIN 46228, Part 1/08.92 | www.wago.com/216-142 |
|  | Item no.: 216-143 Ferrule; Sleeve for 1 mm ² / AWG 18; uninsulated; electro-tin plated; electrolytic copper; gastight crimped; acc. to DIN 46228, Part 1/08.92 | www.wago.com/216-143 |
|  | Item no.: 216-144 Ferrule; Sleeve for 1.5 mm ² / AWG 16; uninsulated; electro-tin plated; electrolytic copper; gastight crimped; acc. to DIN 46228, Part 1/08.92; silver-colored | www.wago.com/216-144 |
|  | Item no.: 216-151 Ferrule; Sleeve for 0.25 mm ² / AWG 24; uninsulated; electro-tin plated | www.wago.com/216-151 |
|  | Item no.: 216-152 Ferrule; Sleeve for 0.34 mm ² / AWG 24; uninsulated; electro-tin plated | www.wago.com/216-152 |
|  | Item no.: 216-201 Ferrule; Sleeve for 0.5 mm ² / 20 AWG; insulated; electro-tin plated; white | www.wago.com/216-201 |
|  | Item no.: 216-202 Ferrule; Sleeve for 0.75 mm ² / 18 AWG; insulated; electro-tin plated; gray | www.wago.com/216-202 |
|  | Item no.: 216-203 Ferrule; Sleeve for 1 mm ² / AWG 18; insulated; electro-tin plated; red | www.wago.com/216-203 |
|  | Item no.: 216-204 Ferrule; Sleeve for 1.5 mm ² / AWG 16; insulated; electro-tin plated; black | www.wago.com/216-204 |
|  | Item no.: 216-221 Ferrule; Sleeve for 0.5 mm ² / 20 AWG; insulated; electro-tin plated; white | www.wago.com/216-221 |
| | Item no.: 216-222 Ferrule; Sleeve for 0.75 mm ² / 18 AWG; insulated; electro-tin plated; gray | www.wago.com/216-222 |

Subject to changes. Please also observe the further product documentation!

| | | |
|--|--|--|
|  | | |
|  | Item no.: 216-223 Ferrule; Sleeve for 1 mm ² / AWG 18; insulated; electro-tin plated; red | www.wago.com/216-223 |
|  | Item no.: 216-224 Ferrule; Sleeve for 1.5 mm ² / AWG 16; insulated; electro-tin plated; black | www.wago.com/216-224 |
|  | Item no.: 216-241 Ferrule; Sleeve for 0.5 mm ² / 20 AWG; insulated; electro-tin plated; electrolytic copper; gastight crimped; acc. to DIN 46228, Part 4/09.90; white | www.wago.com/216-241 |
|  | Item no.: 216-242 Ferrule; Sleeve for 0.75 mm ² / 18 AWG; insulated; electro-tin plated; electrolytic copper; gastight crimped; acc. to DIN 46228, Part 4/09.90; gray | www.wago.com/216-242 |
|  | Item no.: 216-243 Ferrule; Sleeve for 1 mm ² / AWG 18; insulated; electro-tin plated; electrolytic copper; gastight crimped; acc. to DIN 46228, Part 4/09.90; red | www.wago.com/216-243 |
|  | Item no.: 216-244 Ferrule; Sleeve for 1.5 mm ² / AWG 16; insulated; electro-tin plated; electrolytic copper; gastight crimped; acc. to DIN 46228, Part 4/09.90; black | www.wago.com/216-244 |
|  | Item no.: 216-262 Ferrule; Sleeve for 0.75 mm ² / 18 AWG; insulated; electro-tin plated; electrolytic copper; gastight crimped; acc. to DIN 46228, Part 4/09.90; gray | www.wago.com/216-262 |
|  | Item no.: 216-263 Ferrule; Sleeve for 1 mm ² / AWG 18; insulated; electro-tin plated; electrolytic copper; gastight crimped; acc. to DIN 46228, Part 4/09.90; red | www.wago.com/216-263 |
|  | Item no.: 216-264 Ferrule; Sleeve for 1.5 mm ² / AWG 16; insulated; electro-tin plated; electrolytic copper; gastight crimped; acc. to DIN 46228, Part 4/09.90; black | www.wago.com/216-264 |
|  | Item no.: 216-284 Ferrule; Sleeve for 1.5 mm ² / AWG 16; insulated; electro-tin plated; electrolytic copper; gastight crimped; acc. to DIN 46228, Part 4/09.90; black | www.wago.com/216-284 |
| | Item no.: 216-301 Ferrule; Sleeve for 0.25 mm ² / AWG 24; insulated; electro-tin plated; yellow | www.wago.com/216-301 |
|  | Item no.: 216-302 Ferrule; Sleeve for 0.34 mm ² / 22 AWG; insulated; electro-tin plated; green | www.wago.com/216-302 |
| | Item no.: 216-321 Ferrule; Sleeve for 0.25 mm ² / AWG 24; insulated; electro-tin plated; yellow | www.wago.com/216-321 |
|  | Item no.: 216-322 Ferrule; Sleeve for 0.34 mm ² / 22 AWG; insulated; electro-tin plated; green | www.wago.com/216-322 |
| tools | | |
|  | Item no.: 210-250 Operating tool; for MCS MINI & MIDI with CAGE CLAMP® connection; red | www.wago.com/210-250 |

Subject to changes. Please also observe the further product documentation!

| | | |
|--|--|--|
|  | Item no.: 210-251 Operating tool; for MCS MICRO & MINI with CAGE CLAMP® connection; yellow | www.wago.com/210-251 |
|  | Item no.: 210-647 Operating tool; Blade: 2.5 x 0.4 mm; with a partially insulated shaft; multicoloured | www.wago.com/210-647 |
|  | Item no.: 210-719 Operating tool; Blade: 2.5 x 0.4 mm; with a partially insulated shaft | www.wago.com/210-719 |
|  | Item no.: 734-190 Combination operating tool; natural | www.wago.com/734-190 |
|  | Item no.: 734-191 Push-button; loose; black | www.wago.com/734-191 |
|  | Item no.: 734-230 Push-button; white | www.wago.com/734-230 |
|  | Item no.: 734-231 Operating tool; black | www.wago.com/734-231 |
| Insulation stop | | |
|  | Item no.: 734-671 Insulation stop; 0.08 - 0.2 mm ² "s" (0.14 mm ² "f-st"); 8 pieces/strip; light gray | www.wago.com/734-671 |
| Marking accessories | | |
| | Item no.: 210-332/350-202 Marking strips; as a DIN A4 sheet; MARKED; 1-16 (240x); Height of marker strip: 3 mm; Strip length 182 mm; Horizontal marking; Self-adhesive; white | www.wago.com/210-332/350-202 |
| | Item no.: 210-332/350-204 Marking strips; as a DIN A4 sheet; MARKED; 17-32 (240x); Height of marker strip: 3 mm; Strip length 182 mm; Horizontal marking; Self-adhesive; white | www.wago.com/210-332/350-204 |
| | Item no.: 210-332/350-206 Marking strips; as a DIN A4 sheet; MARKED; 33-48 (240x); Height of marker strip: 3 mm; Strip length 182 mm; Horizontal marking; Self-adhesive; white | www.wago.com/210-332/350-206 |
| check | | |
|  | Item no.: 735-500 Test pin; 1 mm Ø; with solder connection for test wire | www.wago.com/735-500 |

Downloads

Documentation

Additional Information

| | | | |
|------------------------|------------|---------------|----------|
| Technical explanations | 3. 4. 2019 | pdf 2.0 MB | Download |
|------------------------|------------|---------------|----------|

Subject to changes. Please also observe the further product documentation!

CAD/CAE-Data

CAD data

2D/3D Models 734-114/107-000

[URL](#)

[Download](#)

CAE data

ZUKEN Portal 734-114/107-000

[URL](#)

[Download](#)

Environmental Product Compliance

Compliance Search

Environmental Product Compliance 734-114/107-000

[URL](#)

[Download](#)

1-conductor female plug; 100% protected against mismatching; Screw flange; 1.5 mm²;
Pin spacing 3.5 mm; 14-pole; 1,50 mm²; light gray

Installation Notes

Conductor termination

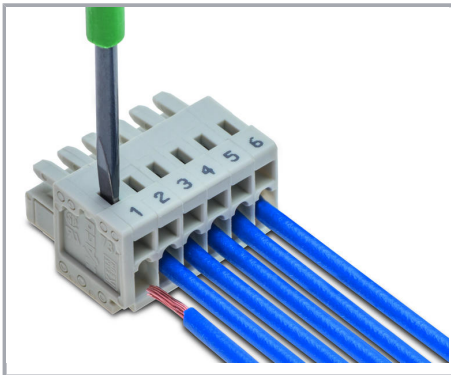

Inserting a conductor via (2.5 x 0.4) mm screwdriver – CAGE CLAMP® actuation perpendicular to conductor entry.

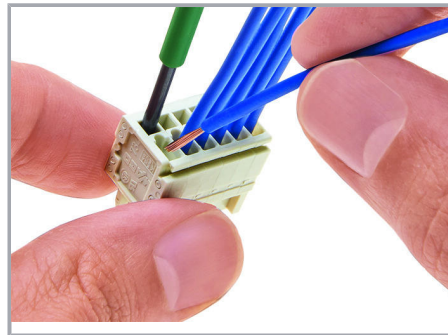

Inserting a conductor via (2.5 x 0.4) mm screwdriver – CAGE CLAMP® actuation parallel to conductor entry.

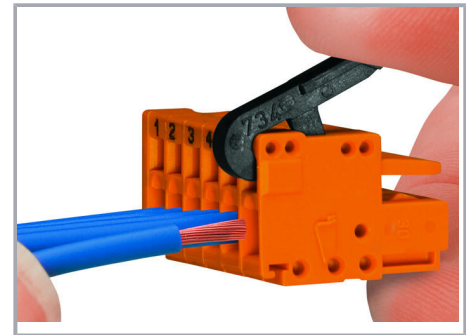

Inserting a conductor into CAGE CLAMP® unit via operating lever (734-191).

Subject to changes. Please also observe the further product documentation!

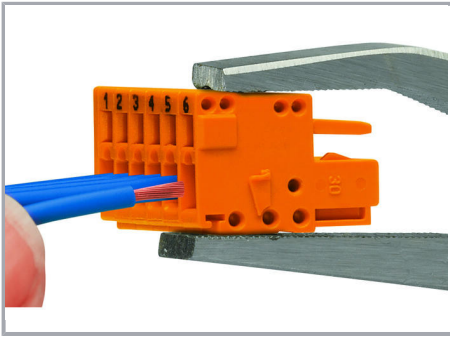

Inserting a conductor into CAGE CLAMP® unit via operating tool (210-251 or 210-250).

Coding

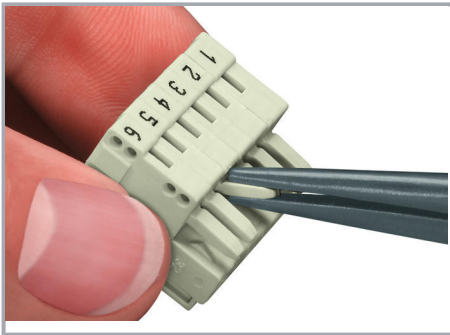

Coding a female connector – removing coding finger(s).

Testing

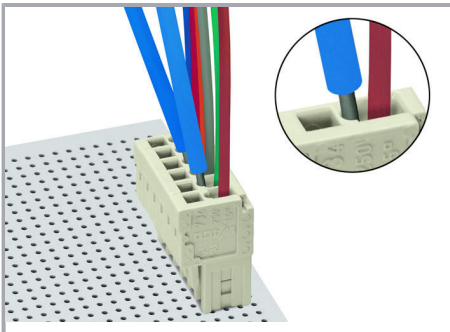

Testing via 1 mm Ø test pin (735-500) – CAGE CLAMP® connection – touch contact.

Marking

Subject to changes. Please also observe the further product documentation!

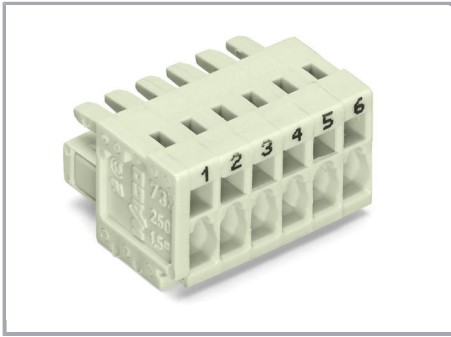

Labeling via direct marking or self-adhesive strips.

Installation

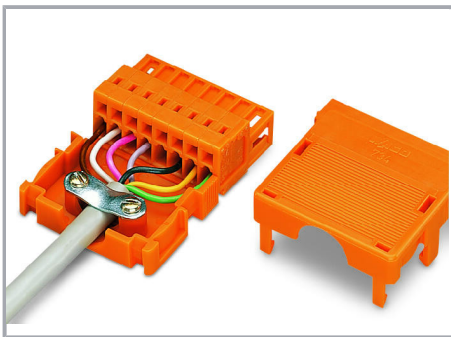

Strain relief housing for 734 Series Male and Female Connectors with CAGE CLAMP® connection

Product family

[*MCS* MINI](#)

[Show all products from the family](#)

Subject to changes. Please also observe the further product documentation!