

1-163038-0 ✓ ACTIVE

MATE-N-LOK | Commercial MATE-N-LOK

TE Internal #: 1-163038-0

Rectangular Power Connectors, Housing, Plug, Wire-to-Panel /  
Wire-to-Wire, 3 Position, 7.11 mm [.28 in] Centerline, Commercial  
MATE-N-LOK

[View on TE.com >](#)



Connectors > Power Connectors > Rectangular Power > Rectangular Power Connectors

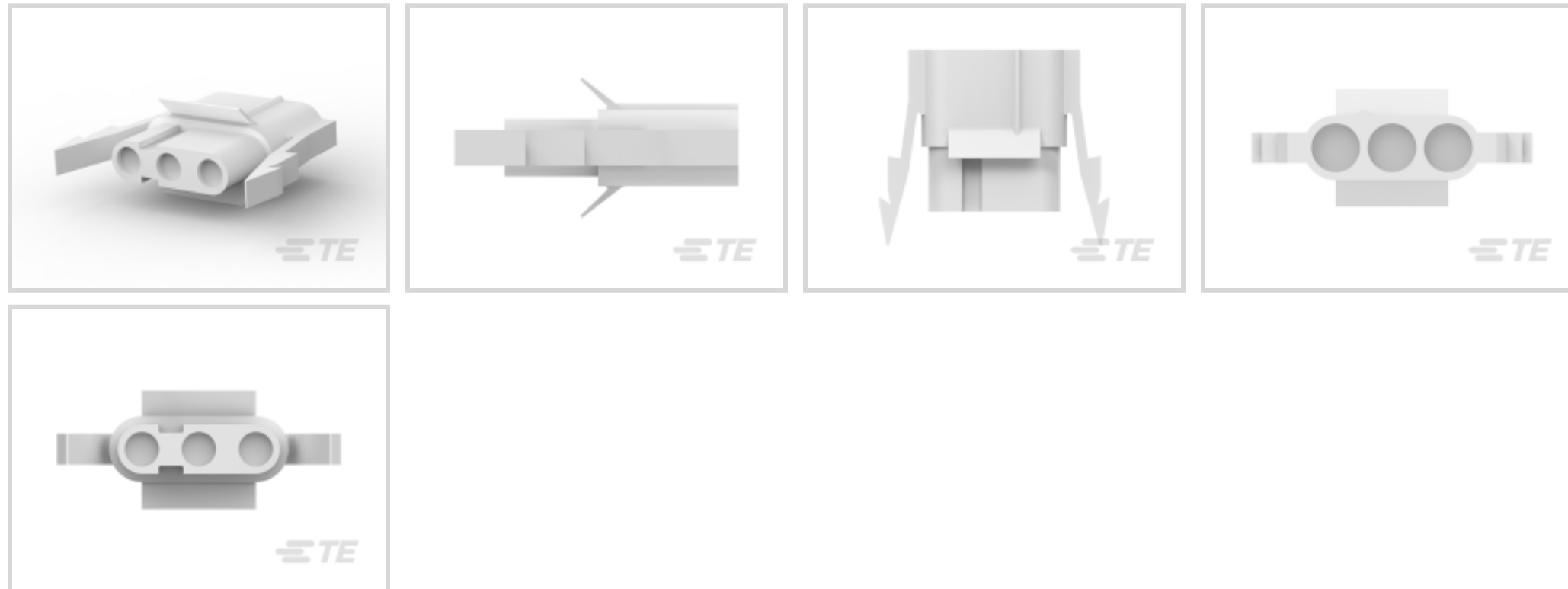

Rectangular Power Connector Type: **Housing**

Connector & Housing Type: **Plug**

Connector System: **Wire-to-Panel, Wire-to-Wire**

Number of Positions: **3**

Centerline (Pitch): **7.11 mm [.28 in]**

## Features

### Product Type Features

Rectangular Power Connector Type	Housing
Connector & Housing Type	Plug
Connector System	Wire-to-Panel, Wire-to-Wire
Sealable	No
Connector & Contact Terminates To	Wire & Cable

### Configuration Features

Number of Positions	3
Number of Rows	1

### Electrical Characteristics

Operating Voltage	250 VAC
-------------------	---------

### Contact Features

Contact Layout	Inline
Contact Retention Within Housing	Without
Contact Type	Socket



### Termination Features

Termination Method to Wire & Cable	Crimp
------------------------------------	-------

### Mechanical Attachment

Panel Mount Feature	With
Panel Mount Feature Type	Locking Leg
Connector Mounting Type	Panel Mount

### Housing Features

Centerline (Pitch)	7.11 mm [.28 in]
Housing Color	Natural
Housing Material	Nylon

### Dimensions

Panel Thickness (Recommended)	.64 – 1.65 mm [.025 – .065 in]
-------------------------------	--------------------------------

### Usage Conditions

Operating Temperature Range	-55 – 105 °C [-67 – 221 °F]
-----------------------------	-----------------------------

### Operation/Application

Circuit Application	Power & Signal
---------------------	----------------

### Identification Marking

Circuit Identification Feature	With
--------------------------------	------

### Industry Standards

CSA Rating	LR 16455
UL Rating	Certified, Recognized
Compatible With Agency/Standards Products	CSA, UL
Compatible With Approved Standards Products	UL E28476
UL Flammability Rating	UL 94V-2
Glow Wire Rating	Standard Part - Not Glow Wire

### Packaging Features

Packaging Quantity	500
Packaging Method	Bag

### Product Compliance

[For compliance documentation, visit the product page on TE.com>](#)



EU RoHS Directive 2011/65/EU	Compliant
EU ELV Directive 2000/53/EC	Compliant
China RoHS 2 Directive MIIT Order No 32, 2016	No Restricted Materials Above Threshold
EU REACH Regulation (EC) No. 1907/2006	Current ECHA Candidate List: JUNE 2024 (241) Candidate List Declared Against: JUNE 2024 (241) Does not contain REACH SVHC
Halogen Content	Low Halogen - Br, Cl, F, I < 900 ppm per homogenous material. Also BFR/CFR/PVC Free
Solder Process Capability	Not applicable for solder process capability

Product Compliance Disclaimer

This information is provided based on reasonable inquiry of our suppliers and represents our current actual knowledge based on the information they provided. This information is subject to change. The part numbers that TE has identified as EU RoHS compliant have a maximum concentration of 0.1% by weight in homogenous materials for lead, hexavalent chromium, mercury, PBB, PBDE, DBP, BBP, DEHP, DIBP, and 0.01% for cadmium, or qualify for an exemption to these limits as defined in the Annexes of Directive 2011/65/EU (RoHS2). Finished electrical and electronic equipment products will be CE marked as required by Directive 2011/65/EU. Components may not be CE marked. Additionally, the part numbers that TE has identified as EU ELV compliant have a maximum concentration of 0.1% by weight in homogenous materials for lead, hexavalent chromium, and mercury, and 0.01% for cadmium, or qualify for an exemption to these limits as defined in the Annexes of Directive 2000/53/EC (ELV). Regarding the REACH Regulation, the information TE provides on SVHC in articles for this part number is based on the latest European Chemicals Agency (ECHA) 'Guidance on requirements for substances in articles' posted at this URL: <https://echa.europa.eu/guidance-documents/guidance-on-reach>

### Compatible Parts

 <p>TE Part # 1-163037-0 03P M-N-L.PIN.HSG.</p>	 <p>TE Part # 151679 2 WAY M-N-L PIN HSG.NAT.</p>	 <p>TE Part # 151680 2 WAY MATE-N-LOK SOC HSG NAT.</p>	 <p>TE Part # 1-163032-0 MATE N LOK HOUSING</p>
--	---	---	--

### Also in the Series | Commercial MATE-N-LOK

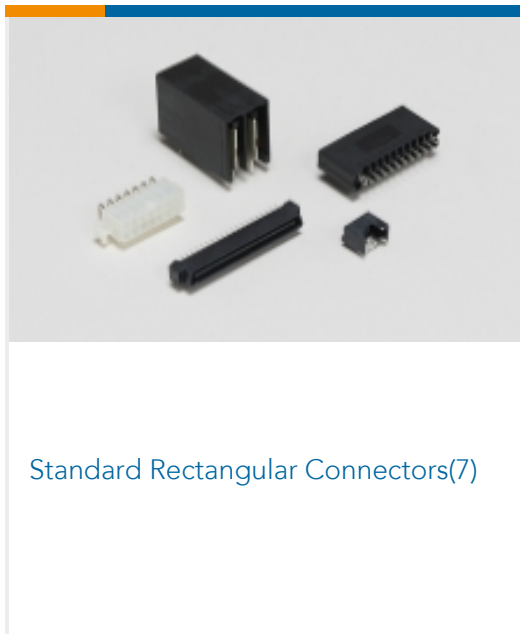
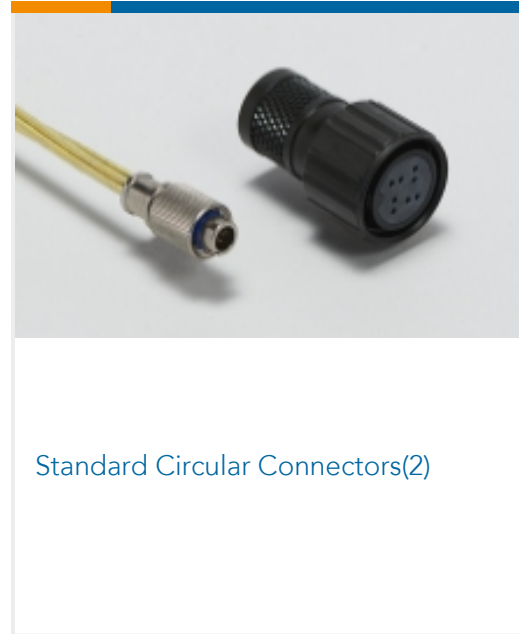
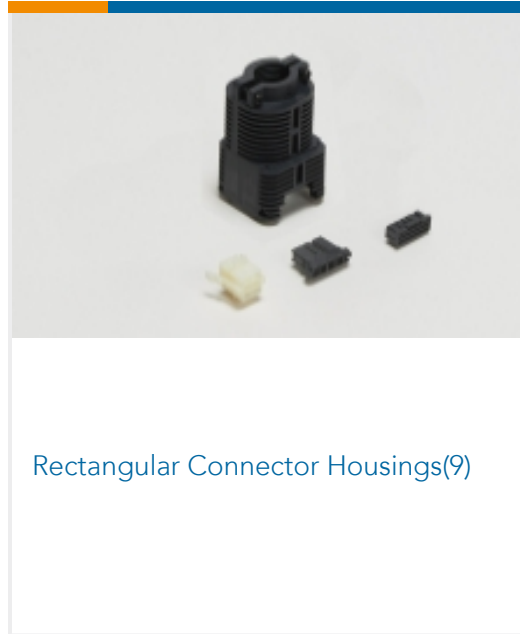
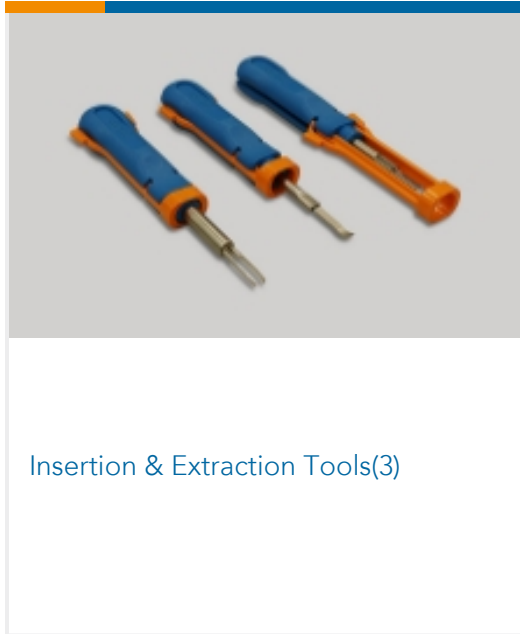
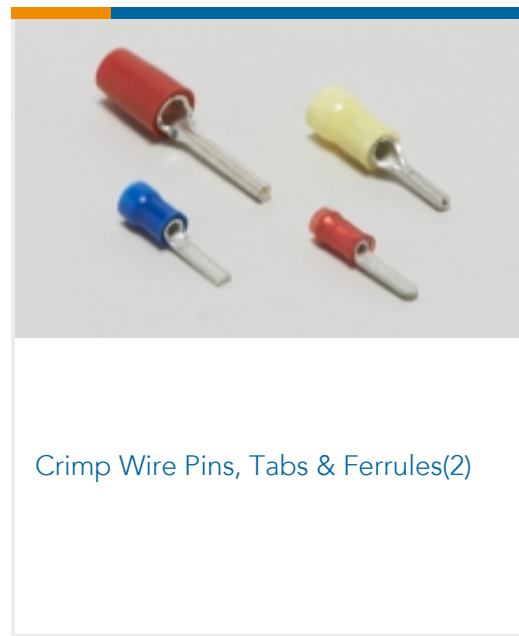
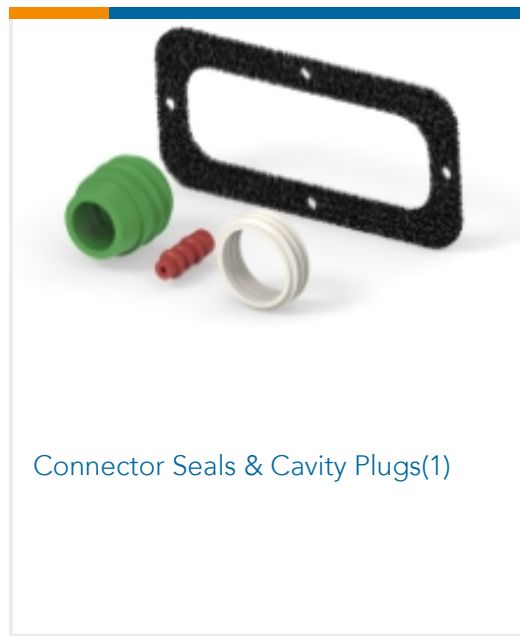
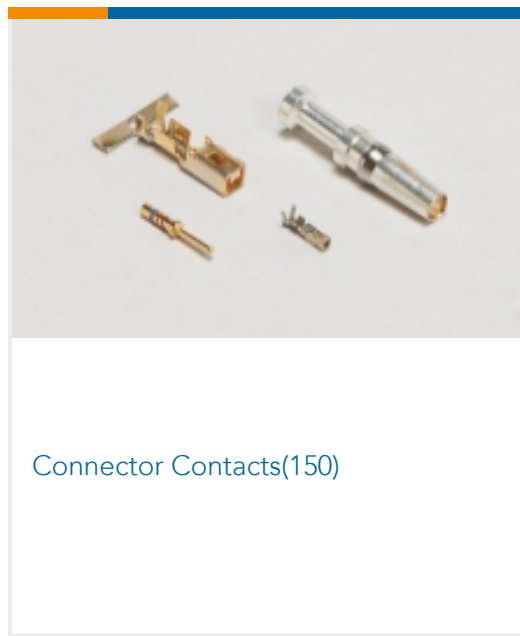

## Customers Also Bought

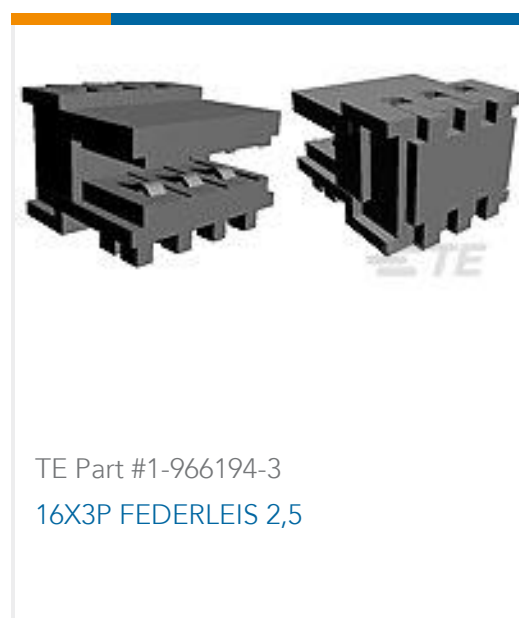

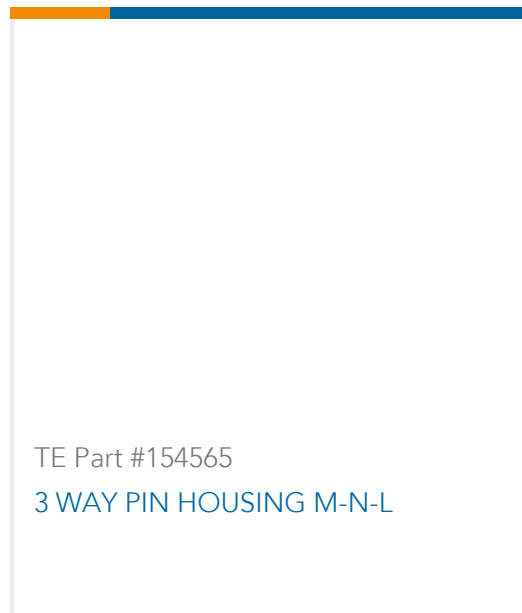

## Documents

### Product Drawings

[03P M-N-L.SOCK.HSG.](#)

English

### CAD Files

Customer View Model

[ENG\\_CVM\\_1-163038-0\\_C.3d\\_igs.zip](#)

English

Customer View Model

[ENG\\_CVM\\_1-163038-0\\_C.3d\\_stp.zip](#)

English

Customer View Model

[ENG\\_CVM\\_1-163038-0\\_C.2d\\_dxf.zip](#)

English

[3D PDF](#)

English

By downloading the CAD file I accept and agree to the [Terms and Conditions](#) of use.

### Product Specifications

[Application Specification](#)

English