

Data sheet | Item number: 2104-1201

2-conductor through terminal block; with lever and Push-in CAGE CLAMP®; 4 mm²; with test port; side and center marking; for DIN-rail 35 x 15 and 35 x 7.5; Push-in CAGE CLAMP®; 4,00 mm²; gray

www.wago.com/2104-1201

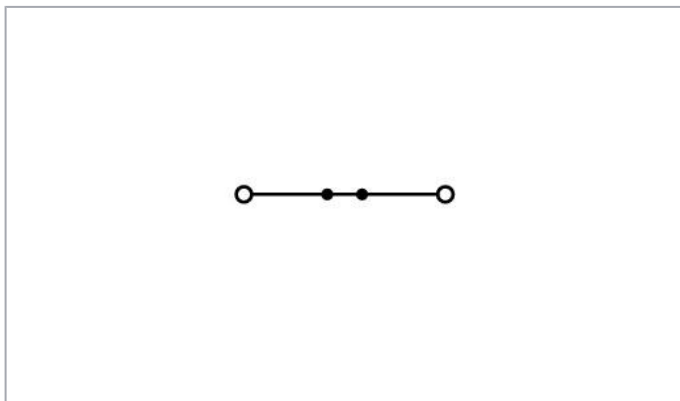
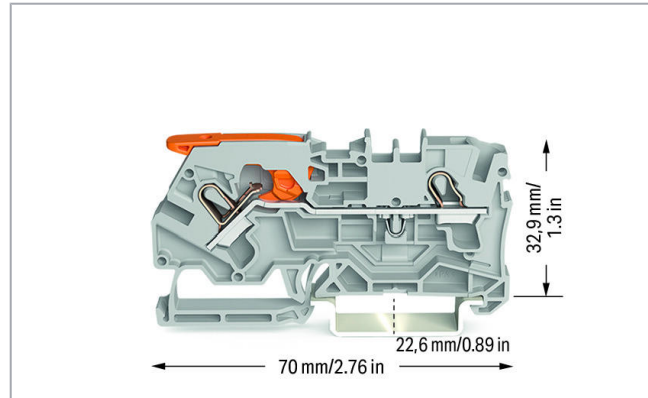
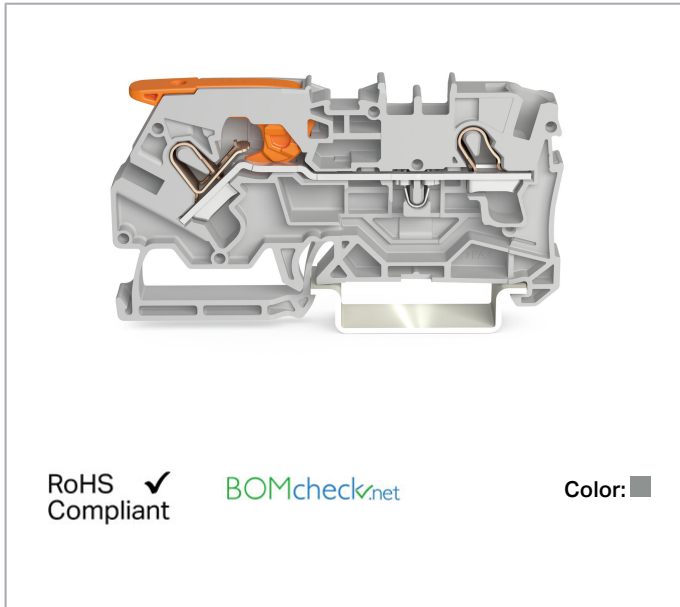

Data

Electrical data

Ratings per IEC/EN

| Ratings per | IEC/EN 60947-7-1 |
|-----------------------------|------------------|
| Nominal voltage (III/3) | 800 V |
| Rated surge voltage (III/3) | 8 kV |
| Rated current | 32 A |

Subject to changes. Please also observe the further product documentation!

WAGO Kontakttechnik GmbH & Co. KG
Hansastr. 27
32423 Minden
Phone: +49571 887-0 | Fax: +49571 887-169
Email: info.de@wago.com | Web: www.wago.com

Do you have any questions about our products?
We are always happy to take your call at 01788 568 008.



| | |
|------------------|--|
| Rated current 2 | 40 A |
| Legend (ratings) | (III / 3) \triangleq Overvoltage category III / Pollution degree 3 |

Ratings per UL

| | |
|--------------------------------|---------|
| Approvals per | UL 1059 |
| Rated voltage UL (Use Group B) | 600 V |
| Rated current UL (Use Group B) | 30 A |
| Rated voltage UL (Use Group C) | 600 V |
| Rated current UL (Use Group C) | 30 A |

Ratings per CSA

| | |
|---------------------------------|--------------|
| Approvals per | C22.2 No 158 |
| Rated voltage CSA (Use Group B) | 600 V |
| Rated current CSA (Use Group B) | 30 A |
| Rated voltage CSA (Use Group C) | 600 V |
| Rated current CSA (Use Group C) | 30 A |

Ex information

| | |
|----------------------------|---|
| Ratings per | ATEX: PTB 20 ATEX 1006 U / IECEx: PTB 20.0012U (Ex eb IIC Gb) |
| Rated voltage EN (Ex e II) | 550 V |
| Rated current (Ex e II) | 30 A |

Connection data

| | |
|--|---|
| Connection technology | Push-in CAGE CLAMP [®] |
| Actuation type | Push-in Lever |
| Connectable conductor materials | Copper |
| Nominal cross-section | 4 mm ² |
| Solid conductor | 0.5 ... 6 mm ² / 20 ... 10 AWG |
| Solid conductor; push-in termination | 1.5 ... 6 mm ² / 14 ... 10 AWG |
| Fine-stranded conductor | 0.5 ... 6 mm ² / 20 ... 10 AWG |
| Fine-stranded conductor; with insulated ferrule | 1.5 ... 4 mm ² / 18 ... 12 AWG |
| Fine-stranded conductor; with ferrule; push-in termination | 1.5 ... 4 mm ² / 18 ... 12 AWG |
| Note (conductor cross-section) | Depending on the conductor characteristic, a conductor with a smaller cross-section can also be inserted via push-in termination. |
| Strip length | 11 ... 13 mm / 0.43 ... 0.51 inch |
| Total number of connection points | 2 |

Subject to changes. Please also observe the further product documentation!

| | |
|----------------------------|---|
| Total number of potentials | 1 |
| Number of levels | 1 |
| Number of jumper slots | 2 |

Physical data

| | |
|------------------------------------|----------------------|
| Width | 6.2 mm / 0.244 inch |
| Height | 70 mm / 2.756 inch |
| Height from upper-edge of DIN-rail | 32.9 mm / 1.295 inch |
| Depth | 70 mm / 2.756 inch |

Mechanical data

| | |
|---------------|---------------------|
| Design | horizontal type |
| Mounting type | DIN-35 rail |
| Marking level | Center/side marking |

Material data

| | |
|---------------------|------------------|
| Color | gray |
| Insulation material | Polyamide (PA66) |
| Weight | 10.3 g |

Commercial data

| | |
|-----------------------|---------------|
| Packaging type | BOX |
| Country of origin | PL |
| GTIN | 4055143992282 |
| Customs tariff number | 85369010000 |

Approvals / Certificates

Ex-Approvals

| Logo | Approval | Additional Approval Text | Certificate name |
|--|--------------------|--------------------------|------------------|
|  Ex e IIC Gb Ex e I Mb | CCCEX CQST/CNEX | CNCA-C23-01 | 2020312313000276 |

Country specific Approvals

| Logo | Approval | Additional Approval Text | Certificate name |
|------|----------|--------------------------|------------------|
|------|----------|--------------------------|------------------|

Subject to changes. Please also observe the further product documentation!



CCA
DEKRA Certification B.V.

EN 60947

NTR NL
7835



KEMA/KEUR
DEKRA Certification B.V.

EN 60947



71-
114078

UL-Approvals

| Logo | Approval | Additional Approval Text | Certificate name |
|--|--------------------------------------|--------------------------|------------------|
|  | UL Underwriters Laboratories Inc. | UL 1059 | E45172 |





Required accessories

End plate

| | | |
|--|--|--|
|  | Item no.: 2104-1291 End and intermediate plate; 1 mm thick; gray | www.wago.com/2104-1291 |
|  | Item no.: 2104-1292 End and intermediate plate; 1 mm thick; orange | www.wago.com/2104-1292 |

Compatible products















Marking accessories

| | | |
|--|--|--|
|  | Item no.: 2009-110 Marking strips; for Smart Printer; on reel; not stretchable; plain; snap-on type; white | www.wago.com/2009-110 |
|  | Item no.: 2009-115 WMB-Inline; for Smart Printer; 1500 pieces on roll; stretchable 5 - 5.2 mm; plain; snap-on type; white | www.wago.com/2009-115 |
|  | Item no.: 2009-115/000-002 WMB-Inline; for Smart Printer; 1500 pieces on roll; stretchable 5 - 5.2 mm; plain; snap-on type; yellow | www.wago.com/2009-115/000-002 |
|  | Item no.: 2009-115/000-005 WMB-Inline; for Smart Printer; 1500 pieces on roll; stretchable 5 - 5.2 mm; plain; snap-on type; red | www.wago.com/2009-115/000-005 |
|  | Item no.: 2009-115/000-006 WMB-Inline; for Smart Printer; 1500 pieces on roll; stretchable 5 - 5.2 mm; plain; snap-on type; blue | www.wago.com/2009-115/000-006 |















Subject to changes. Please also observe the further product documentation!

WAGO Kontakttechnik GmbH & Co. KG
Hansastr. 27
32423 Minden
Phone: +49571 887-0 | Fax: +49571 887-169
Email: info.de@wago.com | Web: www.wago.com

Do you have any questions about our products?
We are always happy to take your call at 01788 568 008.

| | | |
|--|---|--|
|  | Item no.: 2009-115/000-007 WMB-Inline; for Smart Printer; 1500 pieces on roll; stretchable 5 - 5.2 mm; plain; snap-on type; gray | www.wago.com/2009-115/000-007 |
|  | Item no.: 2009-115/000-012 WMB-Inline; for Smart Printer; 1500 pieces on roll; stretchable 5 - 5.2 mm; plain; snap-on type; orange | www.wago.com/2009-115/000-012 |
|  | Item no.: 2009-115/000-017 WMB-Inline; for Smart Printer; 1500 pieces on roll; stretchable 5 - 5.2 mm; plain; snap-on type; light green | www.wago.com/2009-115/000-017 |
|  | Item no.: 2009-115/000-023 WMB-Inline; for Smart Printer; 1500 pieces on roll; stretchable 5 - 5.2 mm; plain; snap-on type; green | www.wago.com/2009-115/000-023 |
|  | Item no.: 2009-115/000-024 WMB-Inline; for Smart Printer; 1500 pieces on roll; stretchable 5 - 5.2 mm; plain; snap-on type; violet | www.wago.com/2009-115/000-024 |
|  | Item no.: 2009-145 Mini-WSB Inline; for Smart Printer; 1700 pieces on roll; stretchable 5 - 5.2 mm; plain; snap-on type; white | www.wago.com/2009-145 |
|  | Item no.: 2009-145/000-002 Mini-WSB Inline; for Smart Printer; 1700 pieces on roll; stretchable 5 - 5.2 mm; plain; snap-on type; yellow | www.wago.com/2009-145/000-002 |
|  | Item no.: 2009-145/000-005 Mini-WSB Inline; for Smart Printer; 1700 pieces on roll; stretchable 5 - 5.2 mm; plain; snap-on type; red | www.wago.com/2009-145/000-005 |
|  | Item no.: 2009-145/000-006 Mini-WSB Inline; for Smart Printer; 1700 pieces on roll; stretchable 5 - 5.2 mm; plain; snap-on type; blue | www.wago.com/2009-145/000-006 |
|  | Item no.: 2009-145/000-007 Mini-WSB Inline; for Smart Printer; 1700 pieces on roll; stretchable 5 - 5.2 mm; plain; snap-on type; gray | www.wago.com/2009-145/000-007 |
|  | Item no.: 2009-145/000-012 Mini-WSB Inline; for Smart Printer; 1700 pieces on roll; stretchable 5 - 5.2 mm; plain; snap-on type; orange | www.wago.com/2009-145/000-012 |
|  | Item no.: 2009-145/000-023 Mini-WSB Inline; for Smart Printer; 1700 pieces on roll; stretchable 5 - 5.2 mm; plain; snap-on type; green | www.wago.com/2009-145/000-023 |
|  | Item no.: 2009-145/000-024 Mini-WSB Inline; for Smart Printer; 1700 pieces on roll; stretchable 5 - 5.2 mm; plain; snap-on type; violet | www.wago.com/2009-145/000-024 |
|  | Item no.: 2009-191 Group marker carrier | www.wago.com/2009-191 |

Subject to changes. Please also observe the further product documentation!

| | | |
|--|--|--|
|  | Item no.: 2009-192 Group marker carrier | www.wago.com/2009-192 |
|  | Item no.: 2009-193 Group marker carrier | www.wago.com/2009-193 |
|  | Item no.: 2009-198 Adaptor; gray | www.wago.com/2009-198 |
|  | Item no.: 248-501 Miniature WSB Quick marking system; plain; Marker width 5 mm; 10 strips with 10 markers per card | www.wago.com/248-501 |
|  | Item no.: 248-501/000-002 Mini-WSB marking card; as card; not stretchable; plain; snap-on type; yellow | www.wago.com/248-501/000-002 |
|  | Item no.: 248-501/000-005 Mini-WSB marking card; as card; not stretchable; plain; snap-on type; red | www.wago.com/248-501/000-005 |
|  | Item no.: 248-501/000-006 Mini-WSB marking card; as card; not stretchable; plain; snap-on type; blue | www.wago.com/248-501/000-006 |
|  | Item no.: 248-501/000-007 Mini-WSB marking card; as card; not stretchable; plain; snap-on type; gray | www.wago.com/248-501/000-007 |
|  | Item no.: 248-501/000-012 Mini-WSB marking card; as card; not stretchable; plain; snap-on type; orange | www.wago.com/248-501/000-012 |
|  | Item no.: 248-501/000-017 Mini-WSB marking card; as card; not stretchable; plain; snap-on type; light green | www.wago.com/248-501/000-017 |
|  | Item no.: 248-501/000-023 Mini-WSB marking card; as card; not stretchable; plain; snap-on type; green | www.wago.com/248-501/000-023 |
|  | Item no.: 248-501/000-024 Mini-WSB marking card; as card; not stretchable; plain; snap-on type; violet | www.wago.com/248-501/000-024 |
|  | Item no.: 793-501 WMB marking card; as card; not stretchable; plain; snap-on type; white | www.wago.com/793-501 |
|  | Item no.: 793-501/000-002 WMB marking card; as card; not stretchable; plain; snap-on type; yellow | www.wago.com/793-501/000-002 |
|  | Item no.: 793-501/000-005 WMB marking card; as card; not stretchable; plain; snap-on type; red | www.wago.com/793-501/000-005 |

Subject to changes. Please also observe the further product documentation!



Item no.: 793-501/000-006
WMB marking card; as card; not stretchable; plain; snap-on type; blue

www.wago.com/793-501/000-006



Item no.: 793-501/000-007
WMB marking card; as card; not stretchable; plain; snap-on type; gray

www.wago.com/793-501/000-007



Item no.: 793-501/000-012
WMB marking card; as card; not stretchable; plain; snap-on type; orange

www.wago.com/793-501/000-012



Item no.: 793-501/000-017
WMB marking card; as card; not stretchable; plain; snap-on type; light green

www.wago.com/793-501/000-017



Item no.: 793-501/000-023
WMB marking card; as card; not stretchable; plain; snap-on type; green

www.wago.com/793-501/000-023



Item no.: 793-501/000-024
WMB marking card; as card; not stretchable; plain; snap-on type; violet

www.wago.com/793-501/000-024



Item no.: 793-5501
WMB marking card; as card; for terminal block width 5 - 17.5 mm; stretchable 5 - 5.2 mm; plain; snap-on type; white

www.wago.com/793-5501



Item no.: 793-5501/000-002
WMB marking card; as card; for terminal block width 5 - 17.5 mm; stretchable 5 - 5.2 mm; plain; snap-on type; yellow

www.wago.com/793-5501/000-002



Item no.: 793-5501/000-005
WMB marking card; as card; for terminal block width 5 - 17.5 mm; stretchable 5 - 5.2 mm; plain; snap-on type; red

www.wago.com/793-5501/000-005



Item no.: 793-5501/000-006
WMB marking card; as card; for terminal block width 5 - 17.5 mm; stretchable 5 - 5.2 mm; plain; snap-on type; blue

www.wago.com/793-5501/000-006



Item no.: 793-5501/000-007
WMB marking card; as card; for terminal block width 5 - 17.5 mm; stretchable 5 - 5.2 mm; plain; snap-on type; gray

www.wago.com/793-5501/000-007



Item no.: 793-5501/000-012
WMB marking card; as card; for terminal block width 5 - 17.5 mm; stretchable 5 - 5.2 mm; plain; snap-on type; orange

www.wago.com/793-5501/000-012



Item no.: 793-5501/000-014
WMB marking card; as card; for terminal block width 5 - 17.5 mm; stretchable 5 - 5.2 mm; plain; snap-on type; brown

www.wago.com/793-5501/000-014

Item no.: 793-5501/000-017

Subject to changes. Please also observe the further product documentation!



WMB marking card; as card; for terminal block width 5 - 17.5 mm; stretchable 5 - 5.2 mm; plain; snap-on type; green

www.wago.com/793-5501/000-017



Item no.: 793-5501/000-023

WMB marking card; as card; for terminal block width 5 - 17.5 mm; stretchable 5 - 5.2 mm; plain; snap-on type; light green

www.wago.com/793-5501/000-023



Item no.: 793-5501/000-024

WMB marking card; as card; for terminal block width 5 - 17.5 mm; stretchable 5 - 5.2 mm; plain; snap-on type; violet

www.wago.com/793-5501/000-024

Carrier rail



Item no.: 210-112

Steel carrier rail; 35 x 7.5 mm; 1 mm thick; 2 m long; slotted; according to EN 60715; "Hole width 25 mm; silver-colored

www.wago.com/210-112



Item no.: 210-113

Steel carrier rail; 35 x 7.5 mm; 1 mm thick; 2 m long; unslotted; according to EN 60715; silver-colored

www.wago.com/210-113



Item no.: 210-114

Steel carrier rail; 35 x 15 mm; 1.5 mm thick; 2 m long; unslotted; similar to EN 60715; silver-colored

www.wago.com/210-114



Item no.: 210-115

Steel carrier rail; 35 x 7.5 mm; 1 mm thick; 2 m long; slotted; according to EN 60715; "Hole width 18 mm; silver-colored

www.wago.com/210-115



Item no.: 210-118

Steel carrier rail; 35 x 15 mm; 2.3 mm thick; 2 m long; unslotted; according to EN 60715; silver-colored

www.wago.com/210-118



Item no.: 210-196

Aluminum carrier rail; 35 x 8.2 mm; 1.6 mm thick; 2 m long; unslotted; similar to EN 60715; silver-colored

www.wago.com/210-196



Item no.: 210-197

Steel carrier rail; 35 x 15 mm; 1.5 mm thick; 2 m long; slotted; similar to EN 60715; silver-colored

www.wago.com/210-197



Item no.: 210-198

Copper carrier rail; 35 x 15 mm; 2.3 mm thick; 2 m long; unslotted; according to EN 60715; copper-colored

www.wago.com/210-198



Item no.: 210-504

Steel carrier rail; 35 x 7.5 mm; 1 mm thick; 2 m long; slotted; galvanized; according to EN 60715; silver-colored

www.wago.com/210-504



Item no.: 210-505

Steel carrier rail; 35 x 7.5 mm; 1 mm thick; 2 m long; unslotted; galvanized; according to EN 60715; silver-colored

www.wago.com/210-505



Item no.: 210-506

Steel carrier rail; 35 x 15 mm; 1.5 mm thick; 2 m long; unslotted; galvanized; similar to EN 60715; silver-colored

www.wago.com/210-506



















Item no.: 210-508

Steel carrier rail; 35 x 15 mm; 1.5 mm thick; 2 m long; slotted; galvanized; similar to EN 60715; silver-colored

www.wago.com/210-508

Insulation stop

Subject to changes. Please also observe the further product documentation!

| | | |
|--|--|--|
|  | Item no.: 2004-171 Insulation stop; 0.25 - 0.5 mm ² ; 5 pieces/strip; light gray | www.wago.com/2004-171 |
|  | Item no.: 2004-172 Insulation stop; 0.75 - 1 mm ² ; 5 pieces/strip; dark gray | www.wago.com/2004-172 |
| Protective Warning Marker | | |
|  | Item no.: 2004-115 Protective warning marker; with high-voltage symbol, black; for 5 terminal blocks; yellow | www.wago.com/2004-115 |
| ferrule | | |
|  | Item no.: 216-262 Ferrule; Sleeve for 0.75 mm ² / 18 AWG; insulated; electro-tin plated; electrolytic copper; gastight crimped; acc. to DIN 46228, Part 4/09.90; gray | www.wago.com/216-262 |
|  | Item no.: 216-263 Ferrule; Sleeve for 1 mm ² / AWG 18; insulated; electro-tin plated; electrolytic copper; gastight crimped; acc. to DIN 46228, Part 4/09.90; red | www.wago.com/216-263 |
|  | Item no.: 216-264 Ferrule; Sleeve for 1.5 mm ² / AWG 16; insulated; electro-tin plated; electrolytic copper; gastight crimped; acc. to DIN 46228, Part 4/09.90; black | www.wago.com/216-264 |
|  | Item no.: 216-266 Ferrule; Sleeve for 2.5 mm ² / AWG 14; insulated; electro-tin plated; electrolytic copper; gastight crimped; acc. to DIN 46228, Part 4/09.90; blue | www.wago.com/216-266 |
|  | Item no.: 216-267 Ferrule; Sleeve for 4 mm ² / AWG 12; insulated; electro-tin plated; electrolytic copper; gastight crimped; acc. to DIN 46228, Part 4/09.90; gray | www.wago.com/216-267 |
| tools | | |
|  | Item no.: 210-658 Operating tool; Blade: 3.5 x 0.5 mm; with a partially insulated shaft; angled; short; multicoloured | www.wago.com/210-658 |
|  | Item no.: 210-720 Operating tool; Blade: 3.5 x 0.5 mm; with a partially insulated shaft; multicoloured | www.wago.com/210-720 |
| check | | |
|  | Item no.: 2004-511 Modular TOPJOB®S connector; modular; for jumper contact slot; 1-pole; 4,00 mm ² ; gray | www.wago.com/2004-511 |
|  | Item no.: 2004-549 Spacer module; modular; e.g., for bridging commoned terminal blocks; gray | www.wago.com/2004-549 |
|  | Item no.: 2004-552 Modular TOPJOB®S connector; modular; for jumper contact slot; 2-pole; 4,00 mm ² ; gray | www.wago.com/2004-552 |
|  | Item no.: 2004-553 Modular TOPJOB®S connector; modular; for jumper contact slot; 3-pole; 4,00 mm ² ; gray | www.wago.com/2004-553 |
|  | Item no.: 2004-554 Modular TOPJOB®S connector; modular; for jumper contact slot; 4-pole; 4,00 mm ² ; gray | www.wago.com/2004-554 |
|  | Item no.: 2004-555 Modular TOPJOB®S connector; modular; for jumper contact slot; 5-pole; 4,00 mm ² ; gray | www.wago.com/2004-555 |

Subject to changes. Please also observe the further product documentation!

| | | |
|---|--|--|
|  | Item no.: 2009-174 Test plug adapter; for 4 mm Ø test plugs; for testing TOPJOB®S rail-mounted terminal blocks; gray | www.wago.com/2009-174 |
|---|--|--|

| | | |
|--|---|--|
|  | Item no.: 2009-182 Testing tap; for max. 2.5 mm ² ; tool-free connection for individual test wires 0.08 - 2.5 mm; gray | www.wago.com/2009-182 |
|--|---|--|

| | | |
|--|---|--|
|  | Item no.: 210-136 Test plug; 2 mm Ø; with 500 mm cable; red | www.wago.com/210-136 |
|--|---|--|

Jumper

| | | |
|--|---|--|
|  | Item no.: 2004-402 Jumper; 2-way; insulated; light gray | www.wago.com/2004-402 |
|--|---|--|

| | | |
|--|---|--|
|  | Item no.: 2004-403 Jumper; 3-way; insulated; light gray | www.wago.com/2004-403 |
|--|---|--|

| | | |
|--|---|--|
|  | Item no.: 2004-404 Jumper; 4-way; insulated; light gray | www.wago.com/2004-404 |
|--|---|--|

| | | |
|--|---|--|
|  | Item no.: 2004-405 Jumper; 5-way; insulated; light gray | www.wago.com/2004-405 |
|--|---|--|

| | | |
|--|--|--|
|  | Item no.: 2004-405/011-000 Star point jumper; 3-way; insulated; light gray | www.wago.com/2004-405/011-000 |
|--|--|--|

| | | |
|---|---|--|
|  | Item no.: 2004-406 Jumper; 6-way; insulated; light gray | www.wago.com/2004-406 |
|---|---|--|

| | | |
|--|--|--|
|  | Item no.: 2004-406/020-000 Delta jumper; insulated; light gray | www.wago.com/2004-406/020-000 |
|--|--|--|

| | | |
|--|---|--|
|  | Item no.: 2004-407 Jumper; 7-way; insulated; light gray | www.wago.com/2004-407 |
|--|---|--|

| | | |
|--|---|--|
|  | Item no.: 2004-408 Jumper; 8-way; insulated; light gray | www.wago.com/2004-408 |
|--|---|--|

| | | |
|--|---|--|
|  | Item no.: 2004-409 Jumper; 9-way; insulated; light gray | www.wago.com/2004-409 |
|--|---|--|

| | | |
|--|--|--|
|  | Item no.: 2004-410 Jumper; 10-way; insulated; light gray | www.wago.com/2004-410 |
|--|--|--|

| | | |
|--|---|--|
|  | Item no.: 2004-433 Jumper; from 1 to 3; insulated; light gray | www.wago.com/2004-433 |
|--|---|--|

| | | |
|--|---|--|
|  | Item no.: 2004-434 Jumper; from 1 to 4; insulated; light gray | www.wago.com/2004-434 |
|--|---|--|

| | | |
|--|---|--|
|  | Item no.: 2004-435 Jumper; from 1 to 5; insulated; light gray | www.wago.com/2004-435 |
|--|---|--|

Subject to changes. Please also observe the further product documentation!

| | | |
|--|--|--|
|  | Item no.: 2004-436 Jumper; from 1 to 6; insulated; light gray | www.wago.com/2004-436 |
|  | Item no.: 2004-437 Jumper; from 1 to 7; insulated; light gray | www.wago.com/2004-437 |
|  | Item no.: 2004-438 Jumper; from 1 to 8; insulated; light gray | www.wago.com/2004-438 |
|  | Item no.: 2004-439 Jumper; from 1 to 9; insulated; light gray | www.wago.com/2004-439 |
|  | Item no.: 2004-440 Jumper; from 1 to 10; insulated; light gray | www.wago.com/2004-440 |
|  | Item no.: 210-103 Wire commoning chain; insulated; black | www.wago.com/210-103 |
|  | Item no.: 210-123 Wire commoning chain; insulated; blue | www.wago.com/210-123 |

Downloads

Documentation

Additional Information

| | | | |
|------------------------|------------|---------------|----------|
| Technical explanations | 3. 4. 2019 | pdf 2.2 MB | Download |
|------------------------|------------|---------------|----------|

CAD/CAE-Data

CAD data

| | | |
|------------------------|-----|----------|
| 2D/3D Models 2104-1201 | URL | Download |
|------------------------|-----|----------|

CAE data

| | | |
|------------------------|-----|----------|
| ZUKEN Portal 2104-1201 | URL | Download |
|------------------------|-----|----------|

Installation Notes

Conductor termination

Subject to changes. Please also observe the further product documentation!

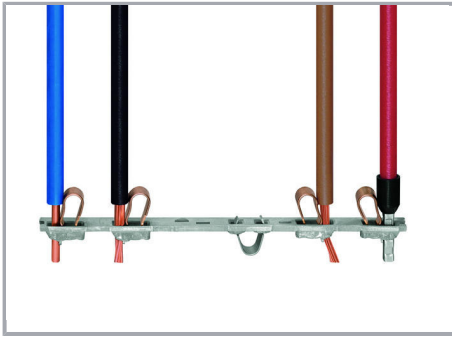

All conductor types at a glance

Product family

TOPJOB® S

TOPJOB® S: In various industrial applications and modern building installations, WAGO's wide and versatile range of rail-mount terminal blocks provides more than just reliable electrical connections.

[Show all products from the family](#)

Subject to changes. Please also observe the further product documentation!