

Data sheet | Item number: 750-482/000-001

2-channel analog input; 4 ... 20 mA HART; NAMUR NE 43; light gray

www.wago.com/750-482/000-001

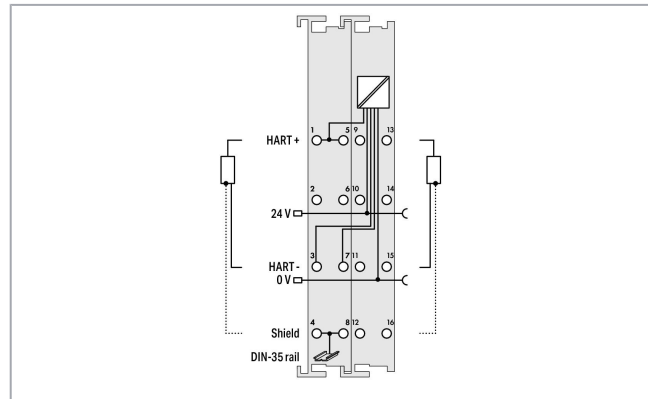
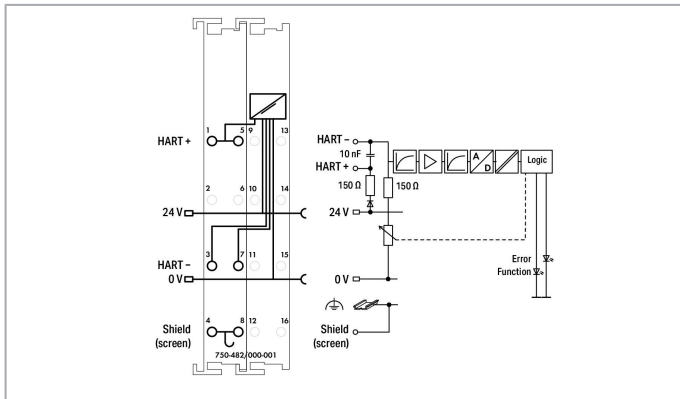
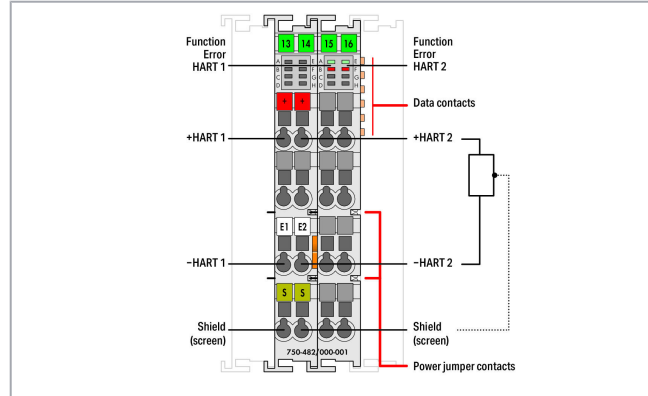
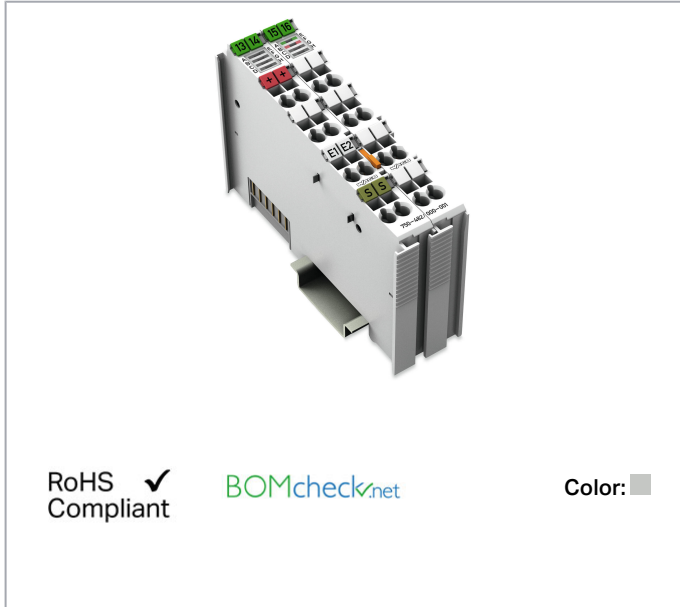

Item description

This analog input module powers field-side signal conditioners and transmits electrically isolated analog signals to the bus system.

The 24 V field supply is derived from the module's power jumper contacts. The shield directly connects to the DIN-rail. At approximately 25 mA, overload protection switches the measurement input to a high-resistance state. Once normal operating conditions resume, the measurement input will automatically switch back. This module powers 2-wire signal conditioners.

Up to 4 HART dynamic variables (PV, SV, TV, QV) per channel can be mapped in the cyclic process image of the coupler or controller (parameterizable). For HART communication with connected intelligent HART field devices, the HART protocol can be mapped in the cyclic process image of the coupler or controller (parameterizable).

Subject to changes. Please also observe the further product documentation!

WAGO Kontakttechnik GmbH & Co. KG
Hansastr. 27
32423 Minden
Phone: +49571 887-0 | Fax: +49571 887-169
Email: info.de@wago.com | Web: www.wago.com

Do you have any questions about our products?
We are always happy to take your call at +49 (571) 887-44222.



FDT/DTM device drivers are available for select (programmable) fieldbus couplers, allowing HART tool routing to the connected HART device.

Note:

The analog output module must only be operated with a field-side power supply filter equipped with overvoltage (surge) protection (Item No. 750-624/020-001)!

Data**Technical data**

Number of analog inputs	2
Total number of channels (module)	2
Signal type	Current
Signal type (current)	DC 3.6 ... 21 mA
Sensor connection	2 x (2-wire)
Input filter	parameterizable
Input filter: parametrizable (channel by channel)	yes
Input voltage (max.)	24 V
Input voltage drop	(I meas < 28 mA): non-linear, overload protected $U = 1.0 \text{ V} + 300 \Omega \times I \text{ meas}$
Signal characteristic	Single-ended
Diagnostics	Wire break, short circuit, measurement range overflow/underflow
Resolution [bit]	12 Bit
Data width	2 x 2-byte data; 2 x 2-byte data + 2n x 4-byte data (n = number of dynamic variables); 2 x 2-byte data + 6-byte mailbox
Overvoltage protection	30 V, reverse polarity protected
Conversion time (typ.)	315 ms
Measurement error (reference temperature)	25 °C
Measurement error – deviation (max.) from the upper-range value	0.2 %
Temperature error (max.) of the upper-range value	0.01 %/K
Line break detection	I meas < 1.0 mA
Short-circuit detection	I meas > 23 mA
Supply voltage (system)	5 VDC; via data contacts
Power consumption (5 V system supply)	25 mA
Supply voltage (field)	24 VDC; via power jumper contacts (power supply via blade contact; transmission via spring contact)
HART devices per channel	One device (single-drop, no multi-drop)
HART modems per channel	One modem (no multiplex)
Isolation	300 VAC system/supply
Number of incoming power jumper contacts	2

Subject to changes. Please also observe the further product documentation!

WAGO Kontakttechnik GmbH & Co. KG

Hansastr. 27

32423 Minden

Phone: +49571 887-0 | Fax: +49571 887-169

Email: info.de@wago.com | Web: www.wago.com

Do you have any questions about our products?

We are always happy to take your call at +49 (571) 887-44222.

Number of outgoing power jumper contacts	2
--	---

Connection data

Connection technology: inputs/outputs	16 x CAGE CLAMP®
Connection type (1)	Inputs/Outputs
Solid conductor	0.08 ... 2.5 mm ² / 28 ... 14 AWG
Fine-stranded conductor	0.08 ... 2.5 mm ² / 28 ... 14 AWG
Strip length	8 ... 9 mm / 0.31 ... 0.35 inch

Physical data

Width	24 mm / 0.945 inch
Height	100 mm / 3.937 inch
Depth	67.8 mm / 2.669 inch
Depth from upper edge of DIN-rail	60.6 mm / 2.386 inch

Mechanical data

Mounting type	DIN-35 rail
---------------	-------------

Material data

Color	light gray
Housing material	Polycarbonate; polyamide 6.6
Fire load	1.419 MJ
Weight	94.2 g
Conformity marking	CE

Environmental requirements

Surrounding air temperature (operation)	0 ... 55 °C
Surrounding air temperature (storage)	-40 ... 85 °C
Protection type	IP20
Pollution degree (5)	2 per IEC 61131-2
Operating altitude	0 ... 2000 m
Mounting position	horizontal (standing/lying); vertical
Relative humidity (without condensation)	95 %
Vibration resistance	per IEC 60068-2-6
Shock resistance	15g per IEC 60068-2-27
EMC immunity to interference	per EN 61000-6-2

Subject to changes. Please also observe the further product documentation!





EMC emission of interference	per EN 61000-6-3
Exposure to pollutants	Per IEC 60068-2-42 and IEC 60068-2-43
Permissible H ₂ S contaminant concentration at a relative humidity 75 %	10 ppm
Permissible SO ₂ contaminant concentration at a relative humidity 75 %	25 ppm

Commercial data

Packaging type	BOX
Country of origin	DE
GTIN	4055143686327
Customs tariff number	85389099990

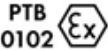
Approvals / Certificates

Ex-Approvals

Logo	Approval	Additional Approval Text	Certificate name
	ATEX TUEV Nord Cert GmbH	EN 60079	TUEV_14_ATEX_148929_X
 Ex nA IIC T4 Gc	CCCEX CQST/CNEx	CNCA-C23-01	2020312310000213
	IECEX TUEV Nord Cert GmbH	IEC 60079	IECEX_TUN_14.0035_X
	UL Underwriters Laboratories Inc. (HAZARDOUS LOCATIONS)	UL 121201	E198726 Sec.1

UL-Approvals

Logo	Approval	Additional Approval Text	Certificate name
	UL Underwriters Laboratories Inc. (ORDINARY LOCATIONS)	UL 508	E175199 Sec.1

Subject to changes. Please also observe the further product documentation!



UL
Underwriters Laboratories Inc. (ORDINARY
LOCATIONS)

UL 61010-2-201

E175199
Sec10

Compatible products

Carrier rail

	Item no.: 210-112 Steel carrier rail; 35 x 7.5 mm; 1 mm thick; 2 m long; slotted; according to EN 60715; "Hole width 25 mm; www.wago.com/210-112 silver-colored	
	Item no.: 210-113 Steel carrier rail; 35 x 7.5 mm; 1 mm thick; 2 m long; unslotted; according to EN 60715; silver-colored	www.wago.com/210-113
	Item no.: 210-114 Steel carrier rail; 35 x 15 mm; 1.5 mm thick; 2 m long; unslotted; similar to EN 60715; silver-colored	www.wago.com/210-114
	Item no.: 210-115 Steel carrier rail; 35 x 7.5 mm; 1 mm thick; 2 m long; slotted; according to EN 60715; "Hole width 18 mm; www.wago.com/210-115 silver-colored	
	Item no.: 210-118 Steel carrier rail; 35 x 15 mm; 2.3 mm thick; 2 m long; unslotted; according to EN 60715; silver-colored	www.wago.com/210-118
	Item no.: 210-196 Aluminum carrier rail; 35 x 8.2 mm; 1.6 mm thick; 2 m long; unslotted; similar to EN 60715; silver-colored	www.wago.com/210-196
	Item no.: 210-197 Steel carrier rail; 35 x 15 mm; 1.5 mm thick; 2 m long; slotted; similar to EN 60715; silver-colored	www.wago.com/210-197
	Item no.: 210-198 Copper carrier rail; 35 x 15 mm; 2.3 mm thick; 2 m long; unslotted; according to EN 60715; copper-colored	www.wago.com/210-198
	Item no.: 210-504 Steel carrier rail; 35 x 7.5 mm; 1 mm thick; 2 m long; slotted; galvanized; according to EN 60715; silver-colored	www.wago.com/210-504
	Item no.: 210-505 Steel carrier rail; 35 x 7.5 mm; 1 mm thick; 2 m long; unslotted; galvanized; according to EN 60715; silver-colored	www.wago.com/210-505
	Item no.: 210-506 Steel carrier rail; 35 x 15 mm; 1.5 mm thick; 2 m long; unslotted; galvanized; similar to EN 60715; silver-colored	www.wago.com/210-506
	Item no.: 210-508 Steel carrier rail; 35 x 15 mm; 1.5 mm thick; 2 m long; slotted; galvanized; similar to EN 60715; silver-colored	www.wago.com/210-508

Supply module

	Item no.: 750-601 Power Supply; 24 VDC; fuse holder; light gray	www.wago.com/750-601
--	---	--

Subject to changes. Please also observe the further product documentation!



Item no.: 750-602
Power Supply; 24 VDC; light gray

www.wago.com/750-602



Item no.: 750-610
Power Supply; 24 VDC; fuse holder; Diagnostics

www.wago.com/750-610





Item no.: 750-612
Power Supply; 0 ... 230 V AC/DC; light gray

www.wago.com/750-612

Marking accessories

 **Item no.: 2009-145**
Mini-WSB Inline; for Smart Printer; 1700 pieces on roll; stretchable 5 - 5.2 mm; plain; snap-on type; white www.wago.com/2009-145

 **Item no.: 2009-145/000-002**
Mini-WSB Inline; for Smart Printer; 1700 pieces on roll; stretchable 5 - 5.2 mm; plain; snap-on type; yellow www.wago.com/2009-145/000-002

 **Item no.: 2009-145/000-005**
Mini-WSB Inline; for Smart Printer; 1700 pieces on roll; stretchable 5 - 5.2 mm; plain; snap-on type; red www.wago.com/2009-145/000-005

 **Item no.: 2009-145/000-006**
Mini-WSB Inline; for Smart Printer; 1700 pieces on roll; stretchable 5 - 5.2 mm; plain; snap-on type; blue www.wago.com/2009-145/000-006

 **Item no.: 2009-145/000-007**
Mini-WSB Inline; for Smart Printer; 1700 pieces on roll; stretchable 5 - 5.2 mm; plain; snap-on type; gray www.wago.com/2009-145/000-007

 **Item no.: 2009-145/000-012**
Mini-WSB Inline; for Smart Printer; 1700 pieces on roll; stretchable 5 - 5.2 mm; plain; snap-on type; orange www.wago.com/2009-145/000-012

 **Item no.: 2009-145/000-023**
Mini-WSB Inline; for Smart Printer; 1700 pieces on roll; stretchable 5 - 5.2 mm; plain; snap-on type; green www.wago.com/2009-145/000-023

 **Item no.: 2009-145/000-024**
Mini-WSB Inline; for Smart Printer; 1700 pieces on roll; stretchable 5 - 5.2 mm; plain; snap-on type; violet www.wago.com/2009-145/000-024

 **Item no.: 248-501**
Miniature WSB Quick marking system; plain; Marker width 5 mm; 10 strips with 10 markers per card www.wago.com/248-501

 **Item no.: 248-501/000-002**
Mini-WSB marking card; as card; not stretchable; plain; snap-on type; yellow www.wago.com/248-501/000-002

 **Item no.: 248-501/000-005**
Mini-WSB marking card; as card; not stretchable; plain; snap-on type; red www.wago.com/248-501/000-005

Subject to changes. Please also observe the further product documentation!



Item no.: 248-501/000-006
Mini-WSB marking card; as card; not stretchable; plain; snap-on type; blue

www.wago.com/248-501/000-006



Item no.: 248-501/000-007
Mini-WSB marking card; as card; not stretchable; plain; snap-on type; gray

www.wago.com/248-501/000-007



Item no.: 248-501/000-012
Mini-WSB marking card; as card; not stretchable; plain; snap-on type; orange

www.wago.com/248-501/000-012



Item no.: 248-501/000-017
Mini-WSB marking card; as card; not stretchable; plain; snap-on type; light green

www.wago.com/248-501/000-017



Item no.: 248-501/000-023
Mini-WSB marking card; as card; not stretchable; plain; snap-on type; green

www.wago.com/248-501/000-023



Item no.: 248-501/000-024
Mini-WSB marking card; as card; not stretchable; plain; snap-on type; violet

www.wago.com/248-501/000-024



Item no.: 750-100
Marker card; as a DIN A4 sheet; plain; white

www.wago.com/750-100



Item no.: 750-103
Group marker carrier; transparent

www.wago.com/750-103



Item no.: 750-106
Group marker carrier; transparent

www.wago.com/750-106

shield connection



Item no.: 790-108
Shield clamping saddle; 11 mm wide; diameter of compatible conductor; 3 ... 8 mm

www.wago.com/790-108



Item no.: 790-116
Shield clamping saddle; 19 mm wide; diameter of compatible conductor; 7 ... 16 mm

www.wago.com/790-116



Item no.: 790-124
Shield clamping saddle; 27 mm wide; diameter of compatible conductor; 6 ... 24 mm

www.wago.com/790-124



Item no.: 790-140
Shield clamping saddle; diameter of compatible conductor

www.wago.com/790-140



Item no.: 790-208
Shield clamping saddle; 12.4 mm wide; 3 ... 8 mm

www.wago.com/790-208



Item no.: 790-216
Shield clamping saddle; 21.8 mm wide; 6 ... 16 mm

www.wago.com/790-216

Subject to changes. Please also observe the further product documentation!



Item no.: 790-220
Shield clamping saddle; 30 mm wide; 6 ... 20 mm

www.wago.com/790-220

system box



Item no.: 850-804
IP65 enclosure; Stainless steel; WxHxD (400x123x200 mm); 4 x M20, 16 x M16, 28 x M12 cable grip

www.wago.com/850-804



Item no.: 850-804/000-001
IP65 enclosure; Stainless steel; WxHxD (400x123x200 mm); 2 x M20, 13 x M16, 32 x M12 cable grip

www.wago.com/850-804/000-001



Item no.: 850-805
IP65 enclosure; Stainless steel; WxHxD (600x123x200 mm); 4 x M20, 19 x M16, 67 x M12 cable grip

www.wago.com/850-805



Item no.: 850-814/002-000
IP65 enclosure; Sheet steel (RAL 7035); WxHxD (200x120x200 mm); without flange plate

www.wago.com/850-814/002-000



Item no.: 850-815/002-000
IP65 enclosure; Sheet steel (RAL 7035); WxHxD (300x120x200 mm); without flange plate

www.wago.com/850-815/002-000



Item no.: 850-816/002-000
IP65 enclosure; Sheet steel (RAL 7035); WxHxD (400x120x200 mm); without flange plate

www.wago.com/850-816/002-000



Item no.: 850-817/002-000
IP65 enclosure; Sheet steel (RAL 7035); WxHxD (600x120x200 mm); without flange plate

www.wago.com/850-817/002-000



Item no.: 850-825
IP65 enclosure; Aluminium (RAL 7032); WxHxD (160x100x160 mm); 9 x M12, 4 x M20

www.wago.com/850-825



Item no.: 850-826
IP65 enclosure; Aluminium (RAL 7032); WxHxD (240x100x160 mm); 4 x M20, 4 x M16, 14 x M12 cable grip

www.wago.com/850-826



Item no.: 850-826/002-000
IP65 enclosure; Aluminium (RAL 7035); WxHxD (240x100x160 mm); 4 x M20, 4 x M16, 14 x M12 cable grip

www.wago.com/850-826/002-000



Item no.: 850-827
IP65 enclosure; Aluminium (RAL 7032); WxHxD (320x100x160 mm); 4 x M20, 8 x M16, 17 x M12 cable grip

www.wago.com/850-827



Item no.: 850-827/002-000
IP65 enclosure; Aluminium (RAL 7035); WxHxD (320x100x160 mm); 4 x M20, 8 x M16, 17 x M12 cable grip

www.wago.com/850-827/002-000



Item no.: 850-828
IP65 enclosure; Aluminium (RAL 7032); WxHxD (480x100x160 mm); 4 x M20, 10 x M16, 35 x M12 cable grip

www.wago.com/850-828

Item no.: 850-828/002-000
IP65 enclosure; Aluminium (RAL 7035); WxHxD (480x100x160 mm); 4 x M20, 10 x M16, 35 x M12 cable

Subject to changes. Please also observe the further product documentation!



grip

www.wago.com/850-828/002-000



Item no.: 850-834

IP65 enclosure; Polyester (RAL 7032); WxHxD (164x100x164 mm); 9 x M12, 4 x M20

www.wago.com/850-834



Item no.: 850-835

IP65 enclosure; Polyester (RAL 7032); WxHxD (244x100x164 mm); 4 x M20, 4 x M16, 14 x M12 cable grip

www.wago.com/850-835



Item no.: 850-836

IP65 enclosure; Polyester (RAL 7032); WxHxD (324x100x164 mm); 4 x M20, 8 x M16, 17 x M12 cable grip

www.wago.com/850-836

Downloads

Documentation

Manual

2-Channel Analog Input, 4-20mA, HART NAMUR NE43, single ended	V 1.0.0	pdf 2.8 MB	Download
Systemhandbuch WAGO I/O System 750 / 753 Dezentrale Automatisierungstechnik	V 3.0.0 4. 3. 2021	pdf 6.6 MB	Download

Bid Text

750-482/000-001 X81 - Datei	19. 2. 2019	xml 6.7 kB	Download
750-482/000-001 doc - Datei	13. 9. 2018	doc 32.3 kB	Download

System Description

Use in Hazardous Environments Term definition, marking and installation regulations	V 1.0.0	pdf 1.0 MB	Download
750/753 Series I/O-System – General Product Information		pdf 1.7 MB	Download
Overview on WAGO-I/O-SYSTEM 750 approvals		pdf 780.2 kB	Download

Additional Information

Disposal; Electrical and electronic equipment, Packaging	V 1.0.0	pdf	Download
--	---------	-----	----------

Subject to changes. Please also observe the further product documentation!

Application Notes

Application Note CoDeSys 2.3

HART Tool Routing via PROFIBUS with 750-833 and 750-333 (a116140)	1.0.0	pdf	Download
This application note describes how to set up asset management systems, which facilitate simple, efficient configuration of HART field devices. Using the Cerabar PMC51 (Endress+Hauser) as an example, connecting any HART sensor to a WAGO PROFIBUS controller and a WAGO PROFIBUS Coupler is explained. The cyclic PROFIBUS Master (750-8208) realizes the data exchange. As an acyclic master, a TH LINK PROFIBUS provides access for the plant asset management applications WAGOframe, PACTware and FieldCare.	22. 3. 2019	5.3 MB	

HART Tool Routing via ETHERNET with 750-820x/750-88x and CODESYS 2.3 (a116120)	1.0.0	pdf	Download
This application note describes how to set up asset management systems, which facilitate simple, efficient configuration of HART field devices. With the Cerabar PMC51 (Endress+Hauser) as an example, a connection is established from any HART sensor to a WAGO PROFIBUS Controller and a WAGO ETHERNET Fieldbus Coupler. The configuration is made with the asset management software WAGOframe, PACTware und FieldCare.	22. 3. 2019	3.9 MB	

Application Note e!COCKPIT

HART Tool Routing via ETHERNET with 750-820x and e!RUNTIME (a116130)	1.0.0	pdf	Download
This application note describes how to set up asset management systems, which facilitate simple, efficient configuration of HART field devices. With the Cerabar PMC51 (Endress+Hauser) as an example, a connection is established from any HART sensor to a WAGO PROFIBUS Controller and a WAGO ETHERNET fieldbus coupler. The configuration is made with the asset management software WAGOframe, PACTware und FieldCare.	22. 3. 2019	2.9 MB	

CAD/CAE-Data

CAD data

2D/3D Models 750-482/000-001	URL	Download
------------------------------	-----	----------

CAE data

EPLAN Data Portal 750-482/000-001	URL	Download
-----------------------------------	-----	----------

ZUKEN Portal 750-482/000-001	URL	Download
------------------------------	-----	----------

Subject to changes. Please also observe the further product documentation!



Environmental Product Compliance

Compliance Search

	URL	Download
Environmental Product Compliance 750-482/000-001 2-channel analog input; 4 ... 20 mA HART; NAMUR NE 43; light gray		

Installation Notes

Product family

750/753 Series I/O System

[Show all products from the family](#)

Subject to changes. Please also observe the further product documentation!