

PC 5/ 5-ST1-7,62 - PCB connector



1777752

<https://www.phoenixcontact.com/sk/products/1777752>

Please be informed that the data shown in this PDF document is generated from our online catalog. Please find the complete data in the user documentation. Our general terms of use for downloads are valid.

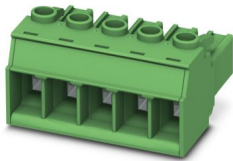

PCB connector, nominal cross section: 6 mm², color: green, nominal current: 41 A, rated voltage (III/2): 1000 V, contact surface: Sn, contact connection type: Socket, number of potentials: 5, number of rows: 1, number of positions: 5, number of connections: 5, product range: PC 5/..-ST1, pitch: 7.62 mm, connection method: Screw connection with tension sleeve, screw head form: H1L Slotted Phillips recess, conductor/PCB connection direction: 0 °, locking clip: - Locking clip, plug-in system: COMBICON PC 5, locking: without, mounting: without, type of packaging: packed in cardboard

Your advantages

- Well-known connection principle allows worldwide use
- Low temperature rise, thanks to maximum contact force
- Allows connection of two conductors
- Integrated double steel spring provides additional safety in the event of temperature and power fluctuations
- 600 V UL approval in the smallest of dimensions

Commercial data

Item number	1777752
Packing unit	50 pc
Minimum order quantity	50 pc
Sales key	AAD
Product key	AADABA
Catalog page	Page 524 (C-1-2013)
GTIN	4046356522892
Weight per piece (including packing)	22.403 g
Weight per piece (excluding packing)	22.363 g
Customs tariff number	85366990
Country of origin	DE

PC 5/ 5-ST1-7,62 - PCB connector



177752

<https://www.phoenixcontact.com/sk/products/177752>

Technical data

Product properties

Product type	PCB connector
Product family	PC 5/...-ST1
Product line	COMBICON Connectors L
Type	Standard
Number of positions	5
Pitch	7.62 mm
Number of connections	5
Number of rows	1
Number of potentials	5
Mounting flange	without

Data management status

Article revision	03
------------------	----

Electrical properties

Nominal current I_N	41 A
Nominal voltage U_N	1000 V
Contact resistance	0.45 m Ω
Rated voltage (III/3)	1000 V
Rated surge voltage (III/3)	8 kV
Rated voltage (III/2)	1000 V
Rated surge voltage (III/2)	8 kV
Rated voltage (II/2)	1000 V
Rated surge voltage (II/2)	6 kV

Connection data

Connection technology

Type	Standard
Connector system	COMBICON PC 5
Nominal cross section	6 mm ²
Contact connection type	Socket

Interlock

Locking type	without
Mounting flange	without

Conductor connection

Connection method	Screw connection with tension sleeve
Conductor/PCB connection direction	0 °
Conductor cross section rigid	0.2 mm ² ... 10 mm ²
Conductor cross section flexible	0.2 mm ² ... 6 mm ²

PC 5/ 5-ST1-7,62 - PCB connector

177752

<https://www.phoenixcontact.com/sk/products/177752>

Conductor cross section AWG	24 ... 10
Conductor cross section flexible, with ferrule without plastic sleeve	0.25 mm ² ... 6 mm ²
Conductor cross section, flexible, with ferrule, with plastic sleeve	0.25 mm ² ... 4 mm ²
2 conductors with same cross section, solid	0.2 mm ² ... 2.5 mm ²
2 conductors with same cross section, flexible	0.2 mm ² ... 4 mm ²
2 conductors with same cross section, flexible, with ferrule without plastic sleeve	0.25 mm ² ... 1.5 mm ²
2 conductors with the same cross section, flexible, with TWIN ferrule with plastic sleeve	0.25 mm ² ... 2.5 mm ²
Cylindrical gauge a x b / diameter	3.6 mm x 3.1 mm / 3.4 mm
Stripping length	10 mm
Drive form screw head	Slotted Phillips recess (H1L)
Tightening torque	0.5 Nm ... 0.8 Nm (≤ 4 mm ² is 0.5 Nm to 0.6 Nm, > 4 mm ² is 0.7 Nm to 0.8 Nm)

Material specifications

Material data - contact

Note	WEEE/RoHS-compliant, free of whiskers according to IEC 60068-2-82/JEDEC JESD 201
Contact material	Cu alloy
Surface characteristics	hot-dip tin-plated
Metal surface terminal point (top layer)	Tin (4 - 8 μm Sn)
Metal surface contact area (top layer)	Tin (4 - 8 μm Sn)

Material data - housing

Color (Housing)	green (6021)
Insulating material	PA
Insulating material group	I
CTI according to IEC 60112	600
Flammability rating according to UL 94	V0
Glow wire flammability index GWFI according to EN 60695-2-12	850
Glow wire ignition temperature GWIT according to EN 60695-2-13	775
Temperature for the ball pressure test according to EN 60695-10-2	125 °C

Dimensions

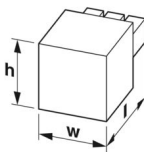
Dimensional drawing	
Pitch	7.62 mm
Width [w]	38.05 mm

PC 5/ 5-ST1-7,62 - PCB connector



1777752

<https://www.phoenixcontact.com/sk/products/1777752>

Height [h]	19.7 mm
Length [l]	35.25 mm

Notes

Notes on operation	In accordance with IEC 61984, COMBICON connectors have no switching power (COC). During designated use, they must not be plugged in or disconnected when carrying voltage or under load.
--------------------	--

Mechanical tests

Test for conductor damage and slackening

Specification	IEC 60999-1:1999-11
Result	Test passed

Pull-out test

Specification	IEC 60999-1:1999-11
Conductor cross section/conductor type/tractive force setpoint/actual value	0.2 mm ² / solid / > 10 N
	0.2 mm ² / flexible / > 10 N
	10 mm ² / solid / > 90 N
	6 mm ² / flexible / > 80 N

Insertion and withdrawal forces

Specification	IEC 60512-13-2:2006-02
Result	Test passed
No. of cycles	50
Insertion strength per pos. approx.	8 N
Withdraw strength per pos. approx.	6 N

Torque test

Specification	IEC 60999-1:1999-11
---------------	---------------------

Resistance of inscriptions

Specification	IEC 60068-2-70:1995-12
Result	Test passed

Polarization and coding

Specification	IEC 60512-13-5:2006-02
Result	Test passed

Visual inspection

Specification	IEC 60512-1-1:2002-02
Result	Test passed

Dimension check

Specification	IEC 60512-1-2:2002-02
Result	Test passed

Environmental and real-life conditions

PC 5/ 5-ST1-7,62 - PCB connector



1777752

<https://www.phoenixcontact.com/sk/products/1777752>

Vibration test

Specification	IEC 60068-2-6:2007-12
Frequency	10 - 150 - 10 Hz
Sweep speed	1 octave/min
Amplitude	0.35 mm (10 Hz ... 60.1 Hz)
Acceleration	5g (60.1 Hz ... 150 Hz)
Test duration per axis	2.5 h
Test directions	X-, Y- and Z-axis

Durability test

Specification	IEC 60512-5:1992-08
Impulse withstand voltage at sea level	7.3 kV
Contact resistance R ₁	0.45 mΩ
Contact resistance R ₂	0.6 mΩ
Insertion/withdrawal cycles	50

Climatic test

Specification	ISO 6988:1985-02
Corrosive stress	0.2 dm ³ SO ₂ on 300 dm ³ /40 °C/1 cycle
Thermal stress	100 °C/168 h
Power-frequency withstand voltage	3.31 kV

Ambient conditions

Ambient temperature (operation)	-40 °C ... 100 °C (dependent on the derating curve)
Ambient temperature (storage/transport)	-40 °C ... 70 °C
Relative humidity (storage/transport)	30 % ... 70 %
Ambient temperature (assembly)	-5 °C ... 100 °C

Electrical tests

Thermal test | Test group C

Specification	IEC 60512-5-1:2002-02
Tested number of positions	12

Insulation resistance

Specification	IEC 60512-3-1:2002-02
Insulation resistance, neighboring positions	>10 ¹² Ω

Air clearances and creepage distances |

Specification	IEC 60664-1:2007-04
Insulating material group	I
Comparative tracking index (IEC 60112)	CTI 600
Rated insulation voltage (III/3)	1000 V
Rated surge voltage (III/3)	8 kV
minimum clearance value - non-homogenous field (III/3)	8 mm
minimum creepage distance (III/3)	12.5 mm

PC 5/ 5-ST1-7,62 - PCB connector



1777752

<https://www.phoenixcontact.com/sk/products/1777752>

Rated insulation voltage (III/2)	1000 V
Rated surge voltage (III/2)	8 kV
minimum clearance value - non-homogenous field (III/2)	8 mm
minimum creepage distance (III/2)	8 mm
Rated insulation voltage (II/2)	1000 V
Rated surge voltage (II/2)	6 kV
minimum clearance value - non-homogenous field (II/2)	5.5 mm
minimum creepage distance (II/2)	5.5 mm

Packaging specifications

Type of packaging	packed in cardboard
-------------------	---------------------

Drawings

Diagram

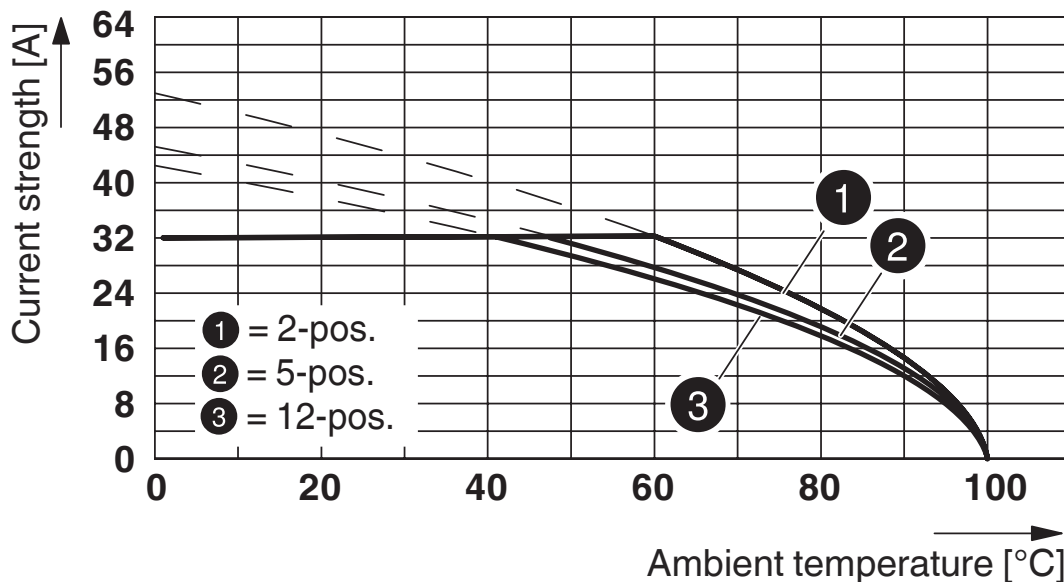

Derating curve for: PC 5/...-ST1-7,62 with PC 4/...-G-7,62
 Conductor cross section: 6 mm²

Diagram

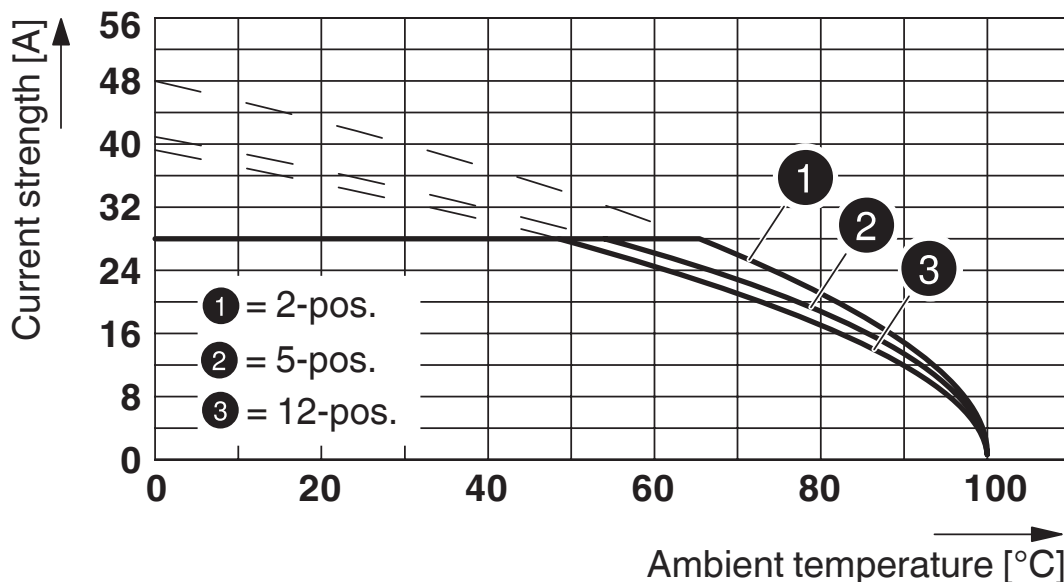

Derating curve for: PC 5/...-ST1-7,62 with PCV 4/...-G-7,62
 Conductor cross section: 4 mm²

177752

<https://www.phoenixcontact.com/sk/products/177752>

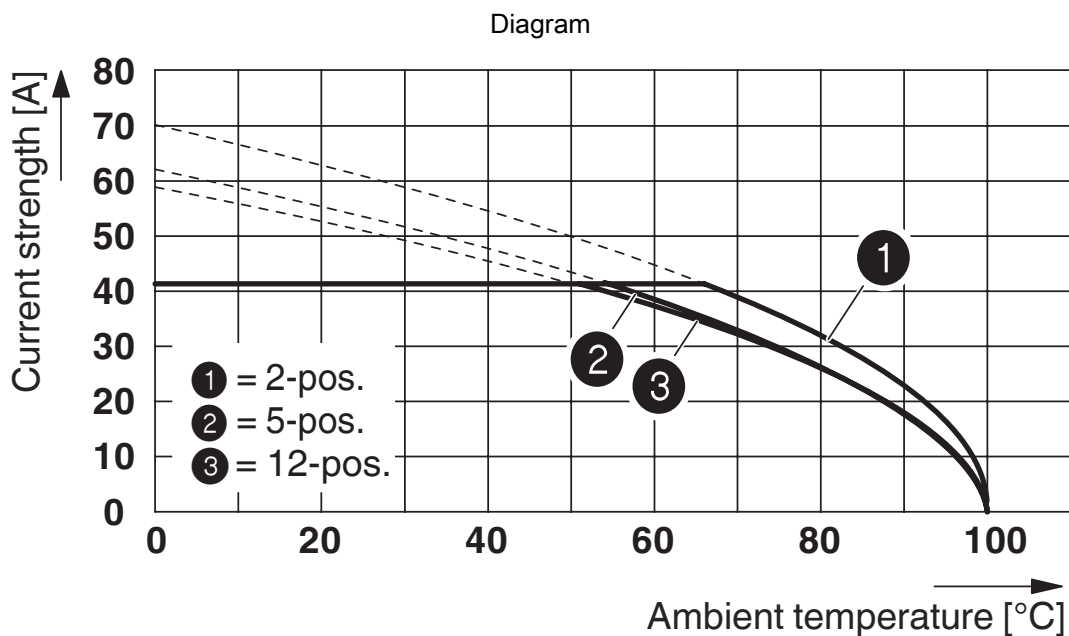

Derating curve for: PC 5/...-ST1-7,62 with PCV 5/...-G-7,62
 Conductor cross section: 10 mm²

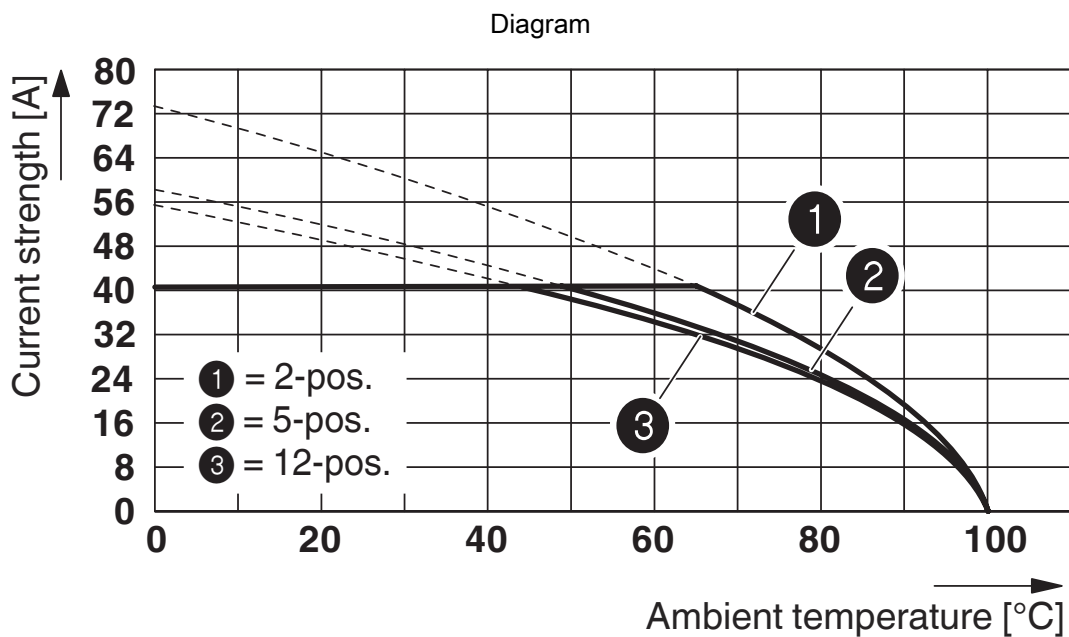

Derating curve for: PC 5/...-ST1-7,62 with PC 5/...-G-7,62
 Conductor cross section: 10 mm²

PC 5/ 5-ST1-7,62 - PCB connector



177752

<https://www.phoenixcontact.com/sk/products/177752>

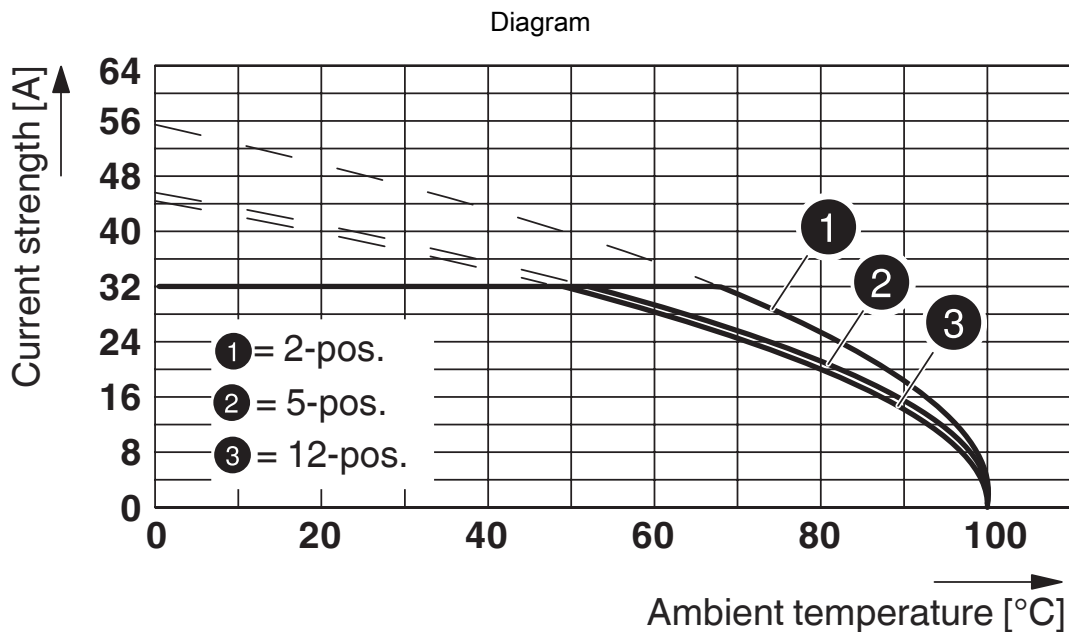

Derating curve for: PC 5/...-ST1-7,62 with PCV 4/...-G-7,62
 Conductor cross section: 6 mm²

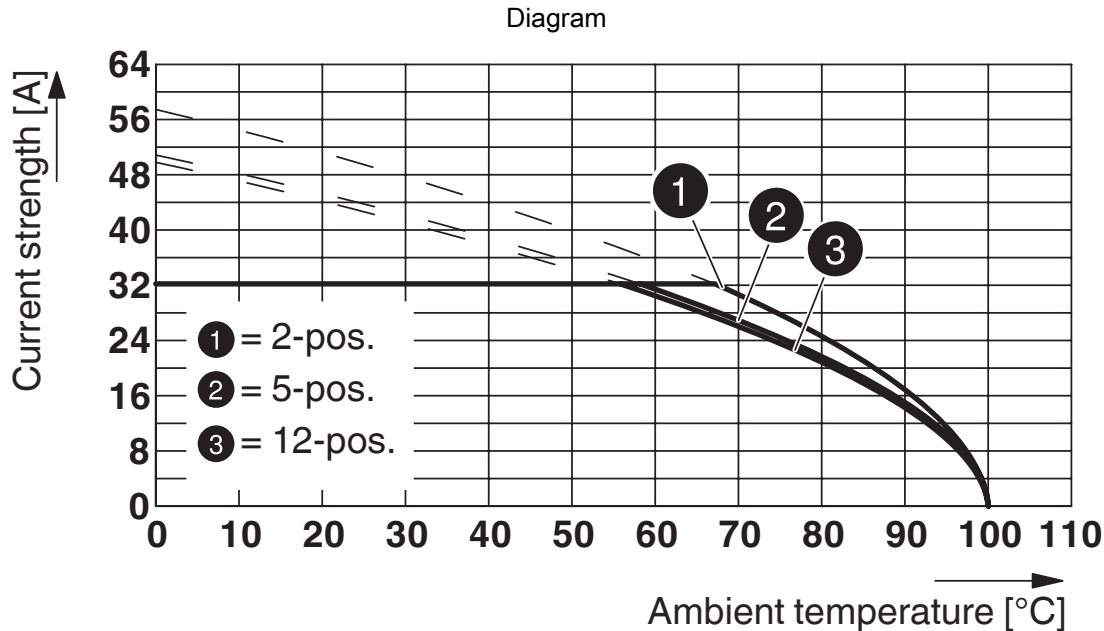

Type: PC 5/...-ST(F)1-7,62 with PC 5/...-GU(F)-7,62
 Conductor cross section: 6 mm²

PC 5/ 5-ST1-7,62 - PCB connector



177752

<https://www.phoenixcontact.com/sk/products/177752>

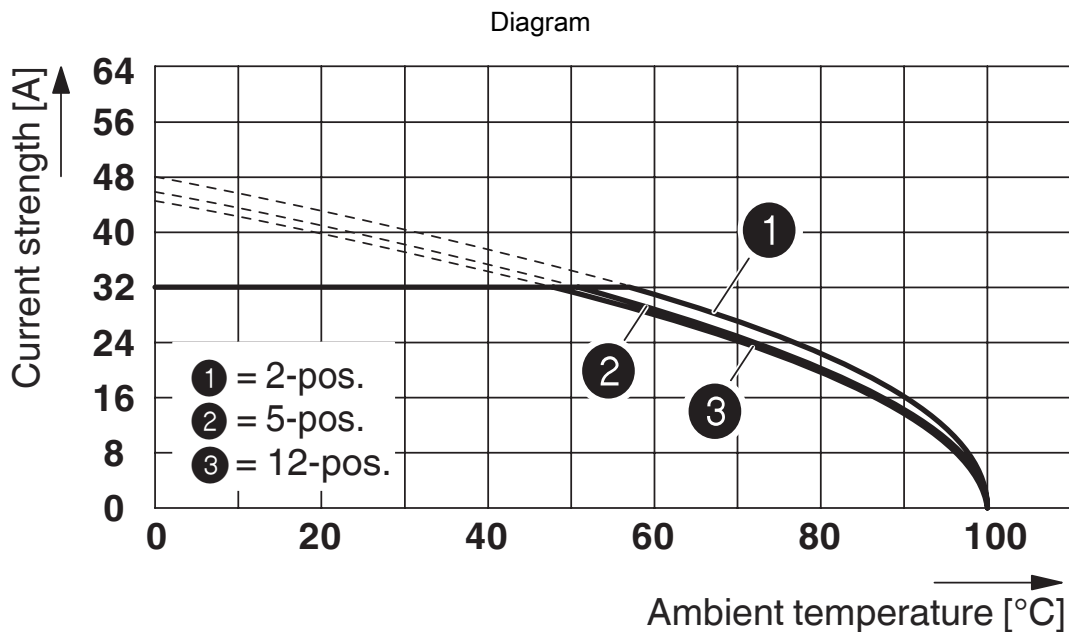

Derating curve for: PC 5/...-ST1-7,62 with PCV 5/...-G-7,62
 Conductor cross section: 6 mm²

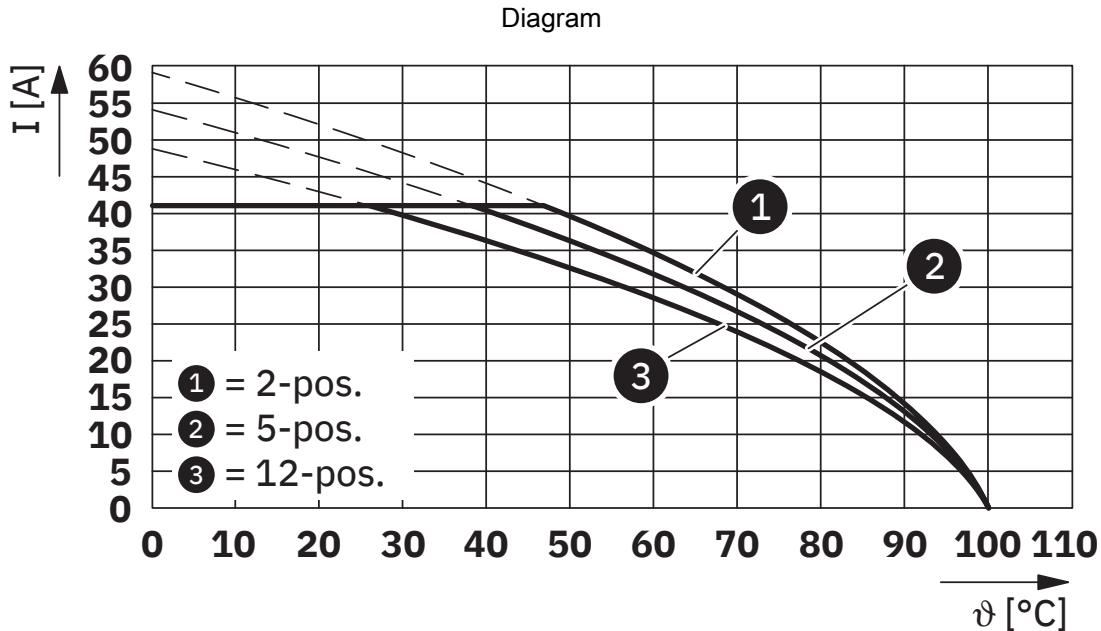

Type: PC 5/...-ST1-7,62 with DFK-PC 5/...-ST-7,62

PC 5/ 5-ST1-7,62 - PCB connector



177752

<https://www.phoenixcontact.com/sk/products/177752>

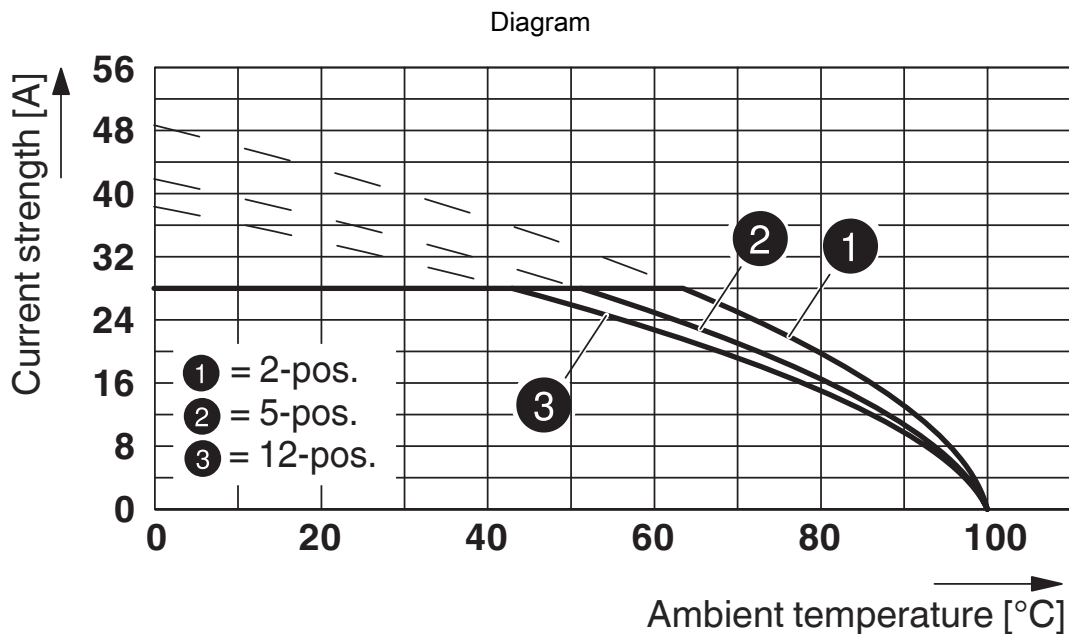

Derating curve for: PC 5/...-ST1-7,62 with PC 4/...-G-7,62
 Conductor cross section: 4 mm²

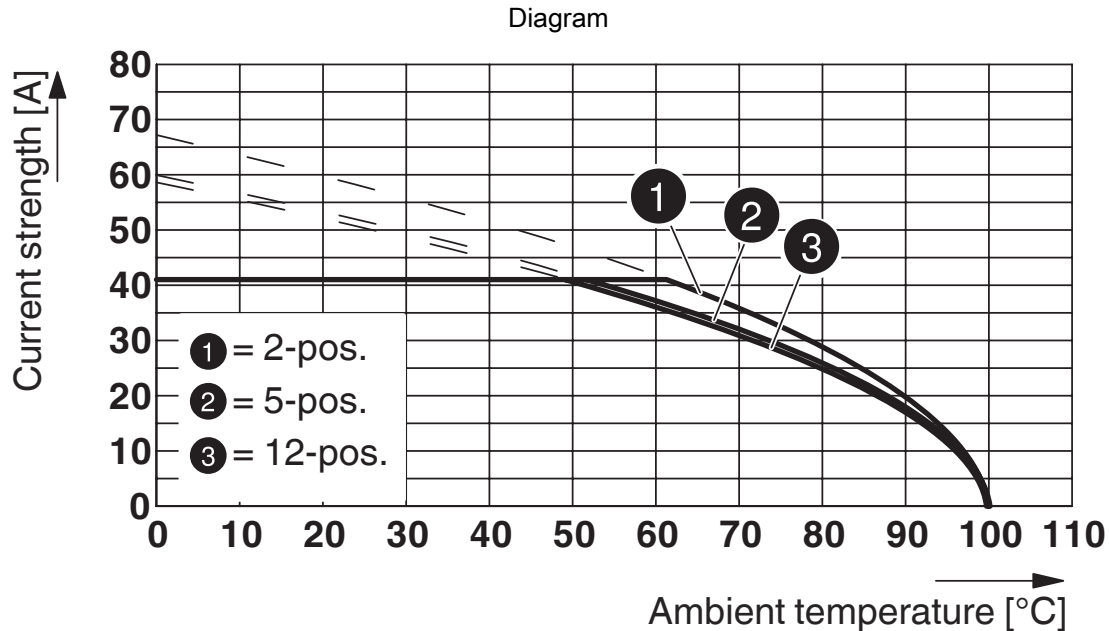

Type: PC 5/...-ST1-7,62 with PC 5/...-GU-7,62 P26 THT R..
 Conductor cross section: 10 mm²

177752

<https://www.phoenixcontact.com/sk/products/177752>

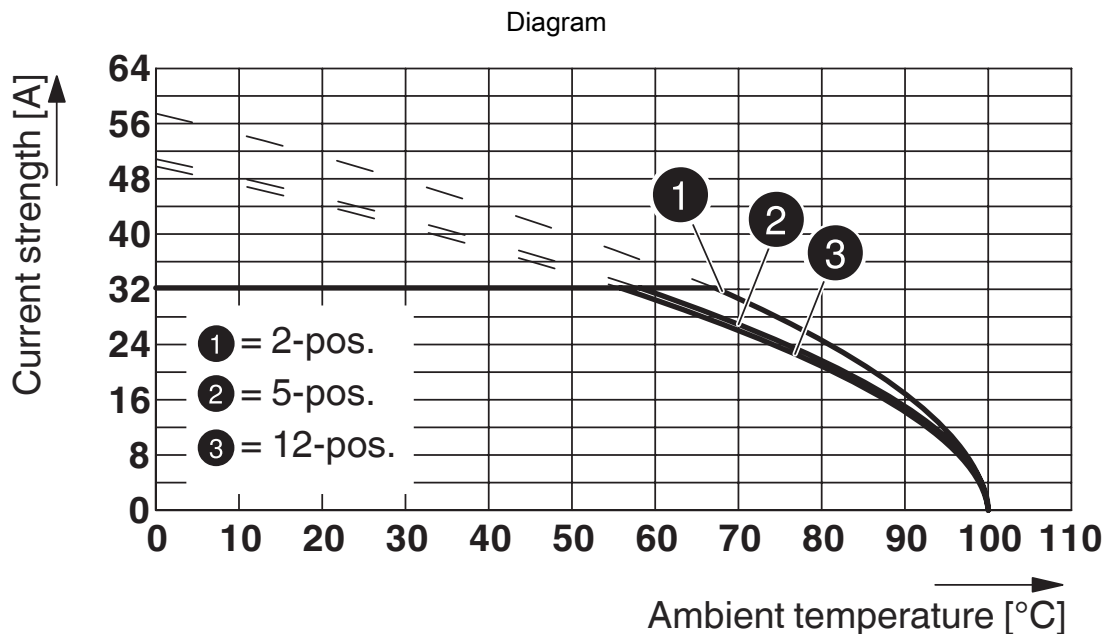

Type: PC 5/...-ST1-7,62 with PC 5/...-GU-7,62 P26 THT R..
 Conductor cross section: 6 mm²

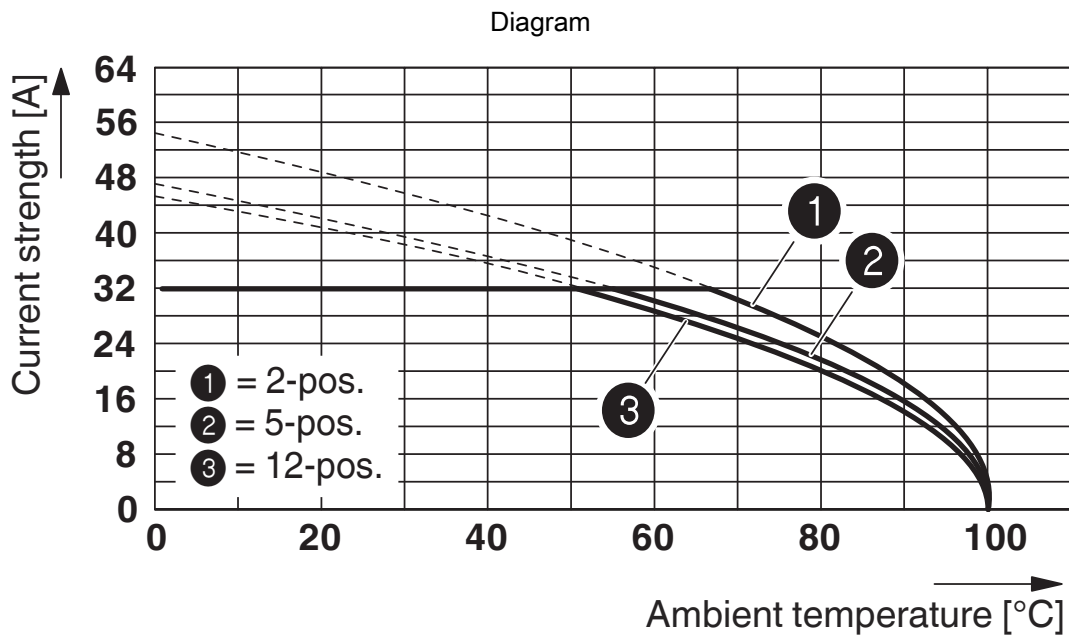

Derating curve for: PC 5/...-ST1-7,62 with PC 5/...-G-7,62
 Conductor cross section: 6 mm²

PC 5/ 5-ST1-7,62 - PCB connector



177752

<https://www.phoenixcontact.com/sk/products/177752>

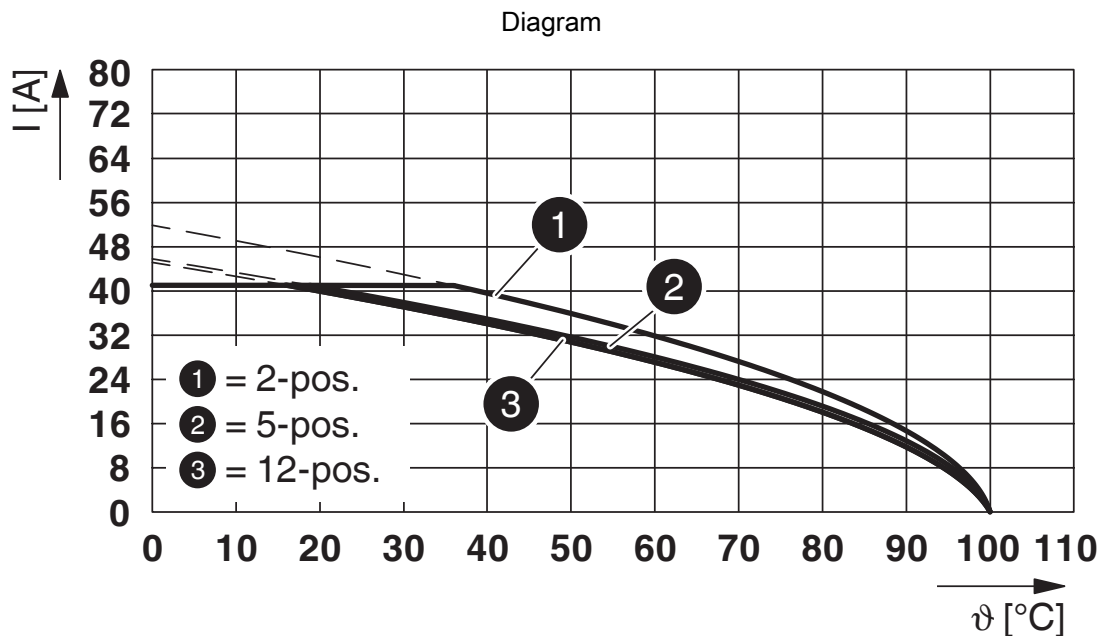

Type: PC 5/...-ST1-7,62 with IPC 5/...-ST-7,62

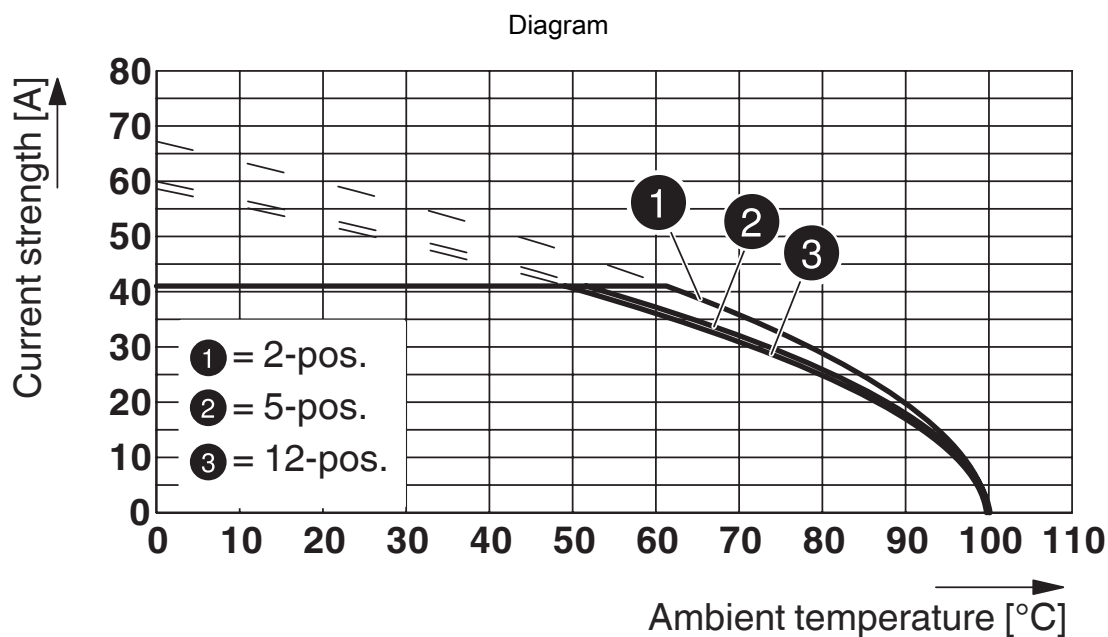

Type: PC 5/...-ST(F)1-7,62 with PC 5/...-G(F)U-7,62

Conductor cross section: 10 mm²

PC 5/ 5-ST1-7,62 - PCB connector



177752

<https://www.phoenixcontact.com/sk/products/177752>

Dimensional drawing

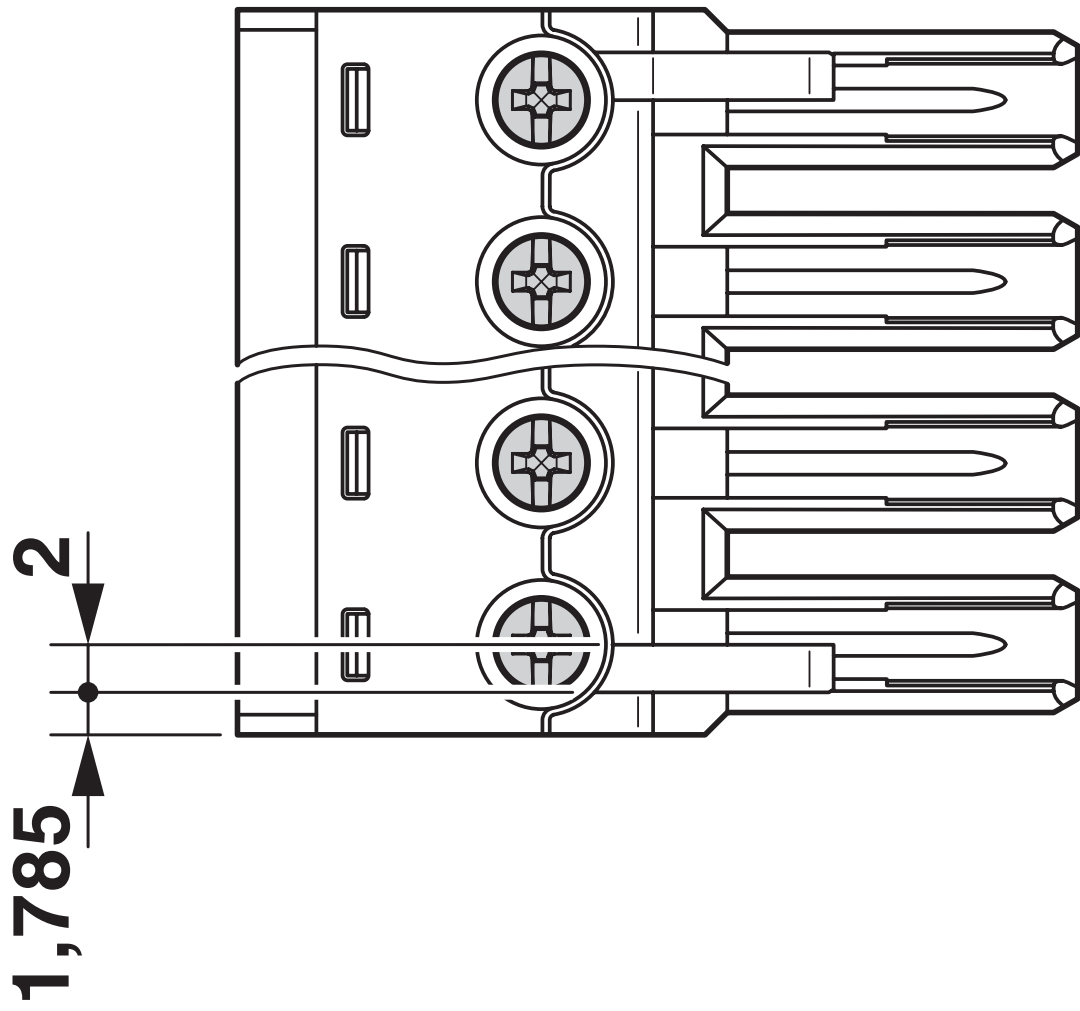

PC 5/ 5-ST1-7,62 - PCB connector

177752

<https://www.phoenixcontact.com/sk/products/177752>

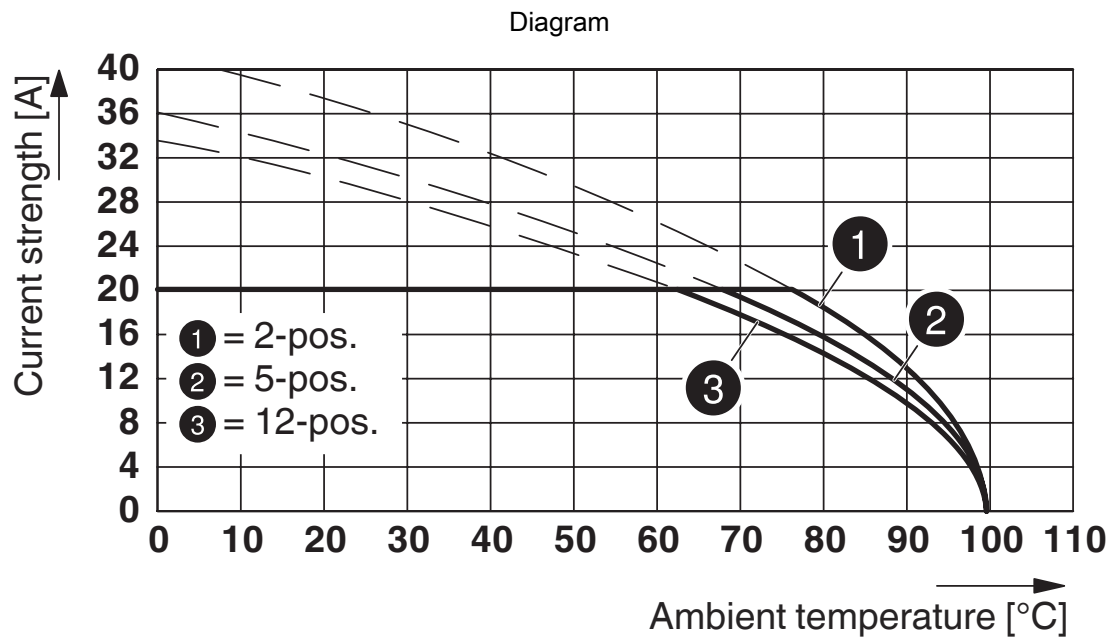

Type: PC 5/...-ST1-7,62 with PCVK 4-7,62

PC 5/ 5-ST1-7,62 - PCB connector



1777752

<https://www.phoenixcontact.com/sk/products/1777752>

Approvals

To download certificates, visit the product detail page: <https://www.phoenixcontact.com/sk/products/1777752>

 cULus Recognized Approval ID: E60425-19920722		Nominal voltage U_N	Nominal current I_N	Cross section AWG	Cross section mm^2
Use group B					
Multi-conductor connection	600 V	41 A	24 - 12	-	
Screw connection	600 V	41 A	24 - 8	-	
Use group C					
Multi-conductor connection	600 V	41 A	24 - 12	-	
Screw connection	600 V	41 A	24 - 8	-	

PC 5/ 5-ST1-7,62 - PCB connector



1777752

<https://www.phoenixcontact.com/sk/products/1777752>

Classifications

ECLASS

ECLASS-11.0	27460202
ECLASS-12.0	27460202
ECLASS-13.0	27460202

ETIM

ETIM 9.0	EC002638
----------	----------

UNSPSC

UNSPSC 21.0	39121400
-------------	----------

PC 5/ 5-ST1-7,62 - PCB connector



177752

<https://www.phoenixcontact.com/sk/products/177752>

Environmental product compliance

EU RoHS

Fulfills EU RoHS substance requirements	Yes, No exemptions
---	--------------------

China RoHS

Environment friendly use period (EFUP)	EFUP-E
	No hazardous substances above the limits

EU REACH SVHC

REACH candidate substance (CAS No.)	No substance above 0.1 wt%
-------------------------------------	----------------------------

EF3.0 Climate Change

CO2e kg	0.135 kg CO2e
---------	---------------

PC 5/ 5-ST1-7,62 - PCB connector

1777752

<https://www.phoenixcontact.com/sk/products/1777752>

Accessories

SZS 0,6X3,5 - Screwdriver

1205053

<https://www.phoenixcontact.com/sk/products/1205053>



Actuation tool, for ST terminal blocks, insulated, also suitable for use as a bladed screwdriver, size: 0.6 x 3.5 x 100 mm, 2-component grip, with non-slip grip

CP-PC RD - Coding profile

1701967

<https://www.phoenixcontact.com/sk/products/1701967>



Coding profile, for plugging into the coding ribs of the plug at a later date, insulating material, color: Red

PC 5/ 5-ST1-7,62 - PCB connector

1777752

<https://www.phoenixcontact.com/sk/products/1777752>

SK 7,62/3,8:FORTL.ZAHLEN - Marker card

0804549

<https://www.phoenixcontact.com/sk/products/0804549>

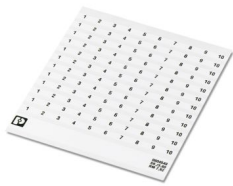

Marker card, white, labeled, horizontal: consecutive numbers 1 ... 10, 11 ... 20, etc. up to 91 ... 100, mounting type: adhesive, for terminal block width: 7.62 mm, text field height: 3.8 mm, text field width: 7.62 mm

SK 3,8 REEL P7,62 WH CUS - Marker card

0825128

<https://www.phoenixcontact.com/sk/products/0825128>



Marker card, can be ordered: by card, white, labeled according to customer specifications, mounting type: adhesive, for terminal block width: 7.62 mm

PC 5/ 5-ST1-7,62 - PCB connector

1777752

<https://www.phoenixcontact.com/sk/products/1777752>

SK U/3,8 WH:UNBEDRUCKT - Marker card

0803906

<https://www.phoenixcontact.com/sk/products/0803906>



Marker card, Din A4, white, unlabeled, can be labeled with: PLOTMARK, CMS-P1-PLOTTER, Office printing systems, mounting type: adhesive, for terminal block width: 210 mm, Number of individual labels: 1440, text field height: 3.8 mm, text field width: 186 mm

SK 3,8 WH:REEL - Marker strip

0805218

<https://www.phoenixcontact.com/sk/products/0805218>



Marker strip, Roll, white, unlabeled, can be labeled with: THERMOMARK E.300 (D)/600 (D), THERMOMARK ROLL 2.0, THERMOMARK ROLL, THERMOMARK ROLL X1, THERMOMARK ROLLMASTER 300/600, THERMOMARK X1.2, mounting type: adhesive, Number of individual labels: 12, text field height: 3.8 mm, text field width: 90000 mm

PC 5/ 5-ST1-7,62 - PCB connector

1777752

<https://www.phoenixcontact.com/sk/products/1777752>



IPC 5/ 5-ST-7,62 - PCB connector

1709076

<https://www.phoenixcontact.com/sk/products/1709076>

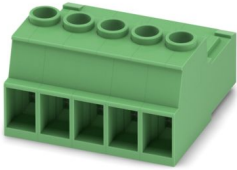

PCB connector, nominal cross section: 6 mm², color: green, nominal current: 41 A, rated voltage (III/2): 1000 V, contact surface: Sn, contact connection type: Pin, number of potentials: 5, number of rows: 1, number of positions: 5, number of connections: 5, product range: IPC 5/..-ST, pitch: 7.62 mm, connection method: Screw connection with tension sleeve, screw head form: Z1L Slotted Pozidriv, conductor/PCB connection direction: 0 °, locking clip: - without locking clip, plug-in system: COMBICON PC 5, locking: without, mounting: without, type of packaging: packed in cardboard

ISPC 5/ 5-STGCL-7,62 - PCB connector

1748891

<https://www.phoenixcontact.com/sk/products/1748891>



PCB connector, nominal cross section: 6 mm², color: green, nominal current: 41 A, rated voltage (III/2): 1000 V, contact surface: Sn, contact connection type: Pin, number of potentials: 5, number of rows: 1, number of positions: 5, number of connections: 5, product range: ISPC 5/..-STGCL, pitch: 7.62 mm, connection method: Push-in spring connection, conductor/PCB connection direction: 0 °, locking clip: - without locking clip, plug-in system: COMBICON PC 5, locking: Clip locking, mounting: Click & Lock latching window, type of packaging: packed in cardboard

PC 5/ 5-ST1-7,62 - PCB connector

1777752

<https://www.phoenixcontact.com/sk/products/1777752>

PC 5/ 5-G-7,62 - PCB header

1720495

<https://www.phoenixcontact.com/sk/products/1720495>



PCB headers, nominal cross section: 6 mm², color: green, nominal current: 41 A, rated voltage (III/2): 630 V, contact surface: Sn, contact connection type: Pin, number of potentials: 5, number of rows: 1, number of positions: 5, number of connections: 5, product range: PC 5/..-G, pitch: 7.62 mm, mounting: Wave soldering, pin layout: Linear pinning, solder pin [P]: 5 mm, number of solder pins per potential: 3, plug-in system: COMBICON PC 5, Pin connector pattern alignment: Standard, locking: without, mounting: without, type of packaging: packed in cardboard

PCV 5/ 5-G-7,62 - PCB header

1720602

<https://www.phoenixcontact.com/sk/products/1720602>

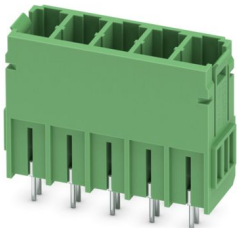

PCB headers, nominal cross section: 6 mm², color: green, nominal current: 41 A, rated voltage (III/2): 630 V, contact surface: Sn, contact connection type: Pin, number of potentials: 5, number of rows: 1, number of positions: 5, number of connections: 5, product range: PCV 5/..-G, pitch: 7.62 mm, mounting: Wave soldering, pin layout: Linear pinning, solder pin [P]: 5 mm, number of solder pins per potential: 3, plug-in system: COMBICON PC 5, Pin connector pattern alignment: Standard, locking: without, mounting: without, type of packaging: packed in cardboard

PC 5/ 5-ST1-7,62 - PCB connector

1777752

<https://www.phoenixcontact.com/sk/products/1777752>

PC 5/ 5-GU-7,62 - PCB header

1720712

<https://www.phoenixcontact.com/sk/products/1720712>

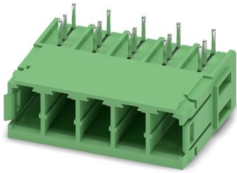

PCB headers, nominal cross section: 6 mm², color: green, nominal current: 41 A, rated voltage (III/2): 630 V, contact surface: Sn, contact connection type: Pin, number of potentials: 5, number of rows: 1, number of positions: 5, number of connections: 5, product range: PC 5/..-GU, pitch: 7.62 mm, mounting: Wave soldering, pin layout: Linear pinning, solder pin [P]: 4.2 mm, number of solder pins per potential: 3, plug-in system: COMBICON PC 5, Pin connector pattern alignment: reversed, locking: without, mounting: without, type of packaging: packed in cardboard

Phoenix Contact 2024 © - all rights reserved

<https://www.phoenixcontact.com>

PHOENIX CONTACT s.r.o.

Námestie Mateja Korvína 1

811 07 Bratislava

+421 2 3210 1470

obchod.sk@phoenixcontact.com