

Data sheet | Item number: 769-209/281-413

2-pin component carrier block; with 2 jumper positions; LED (red); 24 VDC;  
for DIN-rail 35 x 15 and 35 x 7.5; gray

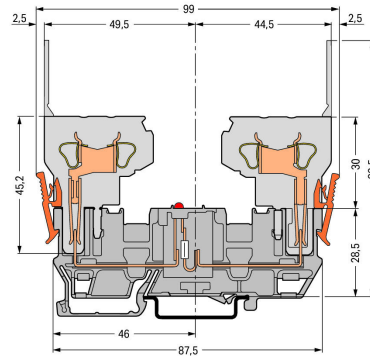

[www.wago.com/769-209/281-413](http://www.wago.com/769-209/281-413)

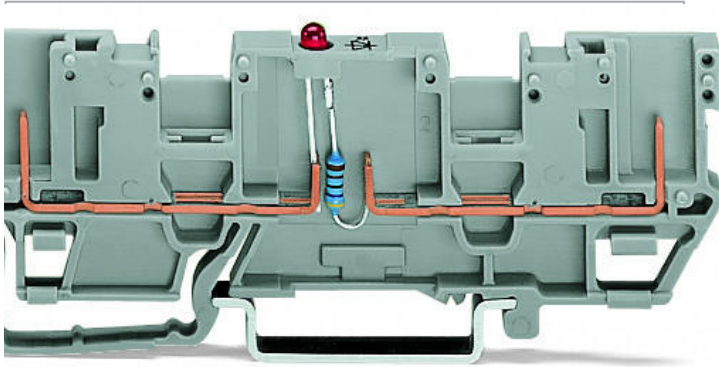

Picture differs from the item.

RoHS   
Compliant

Color:

LED carrier terminal block

For other dimensions, see carrier terminal block (769-151).

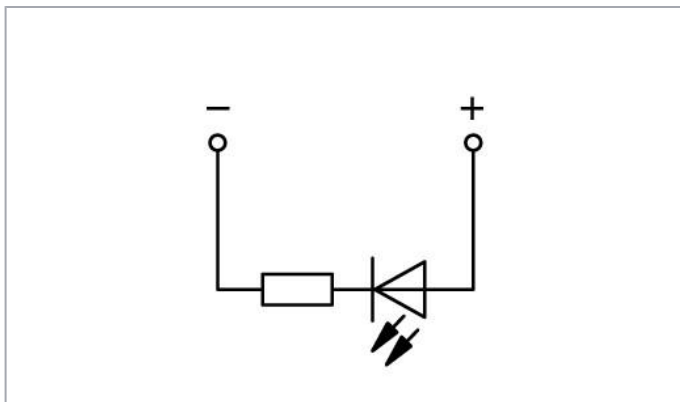

Data

Electrical data

Voltage type 1	DC
Nominal voltage	24 V

Subject to changes. Please also observe the further product documentation!

WAGO Kontakttechnik GmbH & Co. KG  
Hansastr. 27  
32423 Minden  
Phone: +49571 887-0 | Fax: +49571 887-169  
Email: [info.de@wago.com](mailto:info.de@wago.com) | Web: [www.wago.com](http://www.wago.com)

Do you have any questions about our products?  
We are always happy to take your call at 01788 568 008.

**Ratings per IEC/EN**

Rated current	0.025 A
---------------	---------

**Connection data**

Total number of potentials	1
Number of levels	1
Wiring type	Front-entry wiring

**Physical data**

Width	5 mm / 0.197 inch
Height	87.5 mm / 3.445 inch

**Mechanical data**

Design	horizontal type
Mounting type	DIN-35 rail
Marking level	Center marking

**Material data**

Color	gray
Insulation material	Polyamide (PA66)
Fire load	0.159 MJ
Weight	7.6 g

**Commercial data**

Product Group	18 (X-COM-System)
Packaging type	BOX
Country of origin	DE
GTIN	4050821418405
Customs tariff number	85369010000

**Approvals / Certificates****Country specific Approvals**

Logo	Approval	Additional Approval Text	Certificate name
	CCA	EN 60947	NTR NL-

Subject to changes. Please also observe the further product documentation!



DEKRA Certification B.V.

7626

CSA  
DEKRA Certification B.V.

C22.2 No. 158



1101144

KEMA/KEUR  
DEKRA Certification B.V.

EN 60947



2190419.01

## Ship Approvals

Logo	Approval	Additional Approval Text	Certificate name
	<b>ABS</b> American Bureau of Shipping	EN 60947	20- HG1941090- PDA
	<b>DNV GL</b> Det Norske Veritas, Germanischer Lloyd	-	TAE00001V2



## Required accessories

## End plate

	<b>Item no.: 769-309</b> End and intermediate plate; 1.1 mm thick; gray	<a href="http://www.wago.com/769-309">www.wago.com/769-309</a>
	<b>Item no.: 769-310</b> End and intermediate plate; 1.1 mm thick; orange	<a href="http://www.wago.com/769-310">www.wago.com/769-310</a>

## Compatible products

## assembling

	<b>Item no.: 209-106</b> Mounting carrier; for isolated mounting on DIN 35 rails; gray	<a href="http://www.wago.com/209-106">www.wago.com/209-106</a>
	<b>Item no.: 249-116</b> Screwless end stop; 6 mm wide; for DIN-rail 35 x 15 and 35 x 7.5; gray	<a href="http://www.wago.com/249-116">www.wago.com/249-116</a>

## End plate

**Item no.: 769-313**

Subject to changes. Please also observe the further product documentation!



Separator plate; 1.1 mm thick; oversized; orange

[www.wago.com/769-313](http://www.wago.com/769-313)

---

**protection**
**Item no.: 769-438**

Pin cover; with marker slot for miniature WSB; gray

[www.wago.com/769-438](http://www.wago.com/769-438)**Item no.: 769-439**

Pin cover; with marker slot for miniature WSB; orange

[www.wago.com/769-439](http://www.wago.com/769-439)

---

**Jumper**
**Item no.: 280-402**

Jumper; insulated; gray

[www.wago.com/280-402](http://www.wago.com/280-402)**Item no.: 280-409**

Jumper; insulated; gray

[www.wago.com/280-409](http://www.wago.com/280-409)**Item no.: 780-452**

Staggered jumper; from 1 to 2; insulated; gray

[www.wago.com/780-452](http://www.wago.com/780-452)**Item no.: 780-453**

Staggered jumper; from 1 to 3; insulated; gray

[www.wago.com/780-453](http://www.wago.com/780-453)**Item no.: 780-454**

Staggered jumper; from 1 to 4; insulated; gray

[www.wago.com/780-454](http://www.wago.com/780-454)**Item no.: 780-455**

Staggered jumper; from 1 to 5; insulated; gray

[www.wago.com/780-455](http://www.wago.com/780-455)**Item no.: 780-456**

Staggered jumper; from 1 to 6; insulated; gray

[www.wago.com/780-456](http://www.wago.com/780-456)**Item no.: 780-457**

Staggered jumper; from 1 to 7; insulated; gray

[www.wago.com/780-457](http://www.wago.com/780-457)**Item no.: 780-458**

Staggered jumper; from 1 to 8; insulated; gray

[www.wago.com/780-458](http://www.wago.com/780-458)

---

**Coding**
**Item no.: 769-435**

Coding pin; for coding of female plugs; for carrier terminal blocks / male connectors; orange

[www.wago.com/769-435](http://www.wago.com/769-435)

---

**Female plug**
**Item no.: 769-101**1-conductor female plug; 4 mm<sup>2</sup>; 1-pole; 4,00 mm<sup>2</sup>; gray[www.wago.com/769-101](http://www.wago.com/769-101)**Item no.: 769-101/000-006**1-conductor female plug; 4 mm<sup>2</sup>; 1-pole; 4,00 mm<sup>2</sup>; blue[www.wago.com/769-101/000-006](http://www.wago.com/769-101/000-006)**Item no.: 769-101/000-016**1-conductor female plug; 4 mm<sup>2</sup>; 1-pole; 4,00 mm<sup>2</sup>; green-yellow[www.wago.com/769-101/000-016](http://www.wago.com/769-101/000-016)

---

 Subject to changes. Please also observe the further product documentation!

WAGO Kontakttechnik GmbH &amp; Co. KG

Hansastr. 27















32423 Minden

Phone: +49571 887-0 | Fax: +49571 887-169

Email: [info.de@wago.com](mailto:info.de@wago.com) | Web: [www.wago.com](http://www.wago.com)

Do you have any questions about our products?

We are always happy to take your call at 01788 568 008.

	<b>Item no.: 769-101/022-000</b> 1-conductor female plug; angled; 4 mm <sup>2</sup> ; 1-pole; 4,00 mm <sup>2</sup> ; gray	<a href="http://www.wago.com/769-101/022-000">www.wago.com/769-101/022-000</a>
	<b>Item no.: 769-101/022-016</b> 1-conductor female plug; angled; 4 mm <sup>2</sup> ; 1-pole; 4,00 mm <sup>2</sup> ; green-yellow	<a href="http://www.wago.com/769-101/022-016">www.wago.com/769-101/022-016</a>
	<b>Item no.: 769-102</b> 1-conductor female plug; 4 mm <sup>2</sup> ; 2-pole; 4,00 mm <sup>2</sup> ; gray	<a href="http://www.wago.com/769-102">www.wago.com/769-102</a>
	<b>Item no.: 769-102/000-006</b> 1-conductor female plug; 4 mm <sup>2</sup> ; 2-pole; 4,00 mm <sup>2</sup> ; blue	<a href="http://www.wago.com/769-102/000-006">www.wago.com/769-102/000-006</a>
	<b>Item no.: 769-102/000-036</b> 1-conductor female plug; 4 mm <sup>2</sup> ; 2-pole; 4,00 mm <sup>2</sup> ; gray, green-yellow	<a href="http://www.wago.com/769-102/000-036">www.wago.com/769-102/000-036</a>
	<b>Item no.: 769-102/000-037</b> 1-conductor female plug; 4 mm <sup>2</sup> ; 2-pole; 4,00 mm <sup>2</sup> ; green-yellow, gray	<a href="http://www.wago.com/769-102/000-037">www.wago.com/769-102/000-037</a>
	<b>Item no.: 769-102/022-000</b> 1-conductor female plug; angled; 4 mm <sup>2</sup> ; 2-pole; 4,00 mm <sup>2</sup> ; gray	<a href="http://www.wago.com/769-102/022-000">www.wago.com/769-102/022-000</a>
	<b>Item no.: 769-103</b> 1-conductor female plug; 4 mm <sup>2</sup> ; 3-pole; 4,00 mm <sup>2</sup> ; gray	<a href="http://www.wago.com/769-103">www.wago.com/769-103</a>
	<b>Item no.: 769-103/000-006</b> 1-conductor female plug; 4 mm <sup>2</sup> ; 3-pole; 4,00 mm <sup>2</sup> ; blue	<a href="http://www.wago.com/769-103/000-006">www.wago.com/769-103/000-006</a>
	<b>Item no.: 769-103/000-036</b> 1-conductor female plug; 4 mm <sup>2</sup> ; 3-pole; 4,00 mm <sup>2</sup> ; gray, green-yellow	<a href="http://www.wago.com/769-103/000-036">www.wago.com/769-103/000-036</a>
	<b>Item no.: 769-103/000-037</b> 1-conductor female plug; 4 mm <sup>2</sup> ; 3-pole; 4,00 mm <sup>2</sup> ; green-yellow, gray	<a href="http://www.wago.com/769-103/000-037">www.wago.com/769-103/000-037</a>
	<b>Item no.: 769-103/000-038</b> 1-conductor female plug; 4 mm <sup>2</sup> ; 3-pole; 4,00 mm <sup>2</sup> ; gray, blue, green-yellow	<a href="http://www.wago.com/769-103/000-038">www.wago.com/769-103/000-038</a>
	<b>Item no.: 769-103/000-039</b> 1-conductor female plug; 4 mm <sup>2</sup> ; 3-pole; 4,00 mm <sup>2</sup> ; green-yellow, blue, gray	<a href="http://www.wago.com/769-103/000-039">www.wago.com/769-103/000-039</a>
	<b>Item no.: 769-103/022-000</b> 1-conductor female plug; angled; 4 mm <sup>2</sup> ; 3-pole; 4,00 mm <sup>2</sup> ; gray	<a href="http://www.wago.com/769-103/022-000">www.wago.com/769-103/022-000</a>

Subject to changes. Please also observe the further product documentation!



**Item no.: 769-104**

1-conductor female plug; 4 mm²; 4-pole; 4,00 mm²; gray

[www.wago.com/769-104](http://www.wago.com/769-104)



**Item no.: 769-104/000-006**

1-conductor female plug; 4 mm²; 4-pole; 4,00 mm²; blue

[www.wago.com/769-104/000-006](http://www.wago.com/769-104/000-006)



**Item no.: 769-104/000-036**

1-conductor female plug; 4 mm²; 4-pole; 4,00 mm²; gray, green-yellow

[www.wago.com/769-104/000-036](http://www.wago.com/769-104/000-036)



**Item no.: 769-104/000-037**

1-conductor female plug; 4 mm²; 4-pole; 4,00 mm²; green-yellow, gray

[www.wago.com/769-104/000-037](http://www.wago.com/769-104/000-037)



**Item no.: 769-104/000-038**

1-conductor female plug; 4 mm²; 4-pole; 4,00 mm²; gray, blue, green-yellow

[www.wago.com/769-104/000-038](http://www.wago.com/769-104/000-038)



**Item no.: 769-104/000-039**

1-conductor female plug; 4 mm²; 4-pole; 4,00 mm²; green-yellow, blue, gray

[www.wago.com/769-104/000-039](http://www.wago.com/769-104/000-039)



**Item no.: 769-104/022-000**

1-conductor female plug; angled; 4 mm²; 4-pole; 4,00 mm²; gray

[www.wago.com/769-104/022-000](http://www.wago.com/769-104/022-000)



**Item no.: 769-105**

1-conductor female plug; 4 mm²; 5-pole; 4,00 mm²; gray

[www.wago.com/769-105](http://www.wago.com/769-105)



**Item no.: 769-105/000-006**

1-conductor female plug; 4 mm²; 5-pole; 4,00 mm²; blue

[www.wago.com/769-105/000-006](http://www.wago.com/769-105/000-006)



**Item no.: 769-105/000-036**

1-conductor female plug; 4 mm²; 5-pole; 4,00 mm²; gray, green-yellow

[www.wago.com/769-105/000-036](http://www.wago.com/769-105/000-036)



**Item no.: 769-105/000-037**

1-conductor female plug; 4 mm²; 5-pole; 4,00 mm²; green-yellow, gray

[www.wago.com/769-105/000-037](http://www.wago.com/769-105/000-037)



**Item no.: 769-105/000-038**

1-conductor female plug; 4 mm²; 5-pole; 4,00 mm²; gray, blue, green-yellow

[www.wago.com/769-105/000-038](http://www.wago.com/769-105/000-038)



**Item no.: 769-105/000-039**

1-conductor female plug; 4 mm²; 5-pole; 4,00 mm²; green-yellow, blue, gray

[www.wago.com/769-105/000-039](http://www.wago.com/769-105/000-039)



**Item no.: 769-105/022-000**

1-conductor female plug; angled; 4 mm²; 5-pole; 4,00 mm²; gray

[www.wago.com/769-105/022-000](http://www.wago.com/769-105/022-000)

Subject to changes. Please also observe the further product documentation!

WAGO Kontakttechnik GmbH & Co. KG

Hansastr. 27















32423 Minden

Phone: +49571 887-0 | Fax: +49571 887-169

Email: [info.de@wago.com](mailto:info.de@wago.com) | Web: [www.wago.com](http://www.wago.com)

Do you have any questions about our products?

We are always happy to take your call at 01788 568 008.

	<b>Item no.: 769-106</b> 1-conductor female plug; 4 mm <sup>2</sup> ; 6-pole; 4,00 mm <sup>2</sup> ; gray	<a href="http://www.wago.com/769-106">www.wago.com/769-106</a>
	<b>Item no.: 769-106/000-006</b> 1-conductor female plug; 4 mm <sup>2</sup> ; 6-pole; 4,00 mm <sup>2</sup> ; blue	<a href="http://www.wago.com/769-106/000-006">www.wago.com/769-106/000-006</a>
	<b>Item no.: 769-106/000-036</b> 1-conductor female plug; 4 mm <sup>2</sup> ; 6-pole; 4,00 mm <sup>2</sup> ; gray, green-yellow	<a href="http://www.wago.com/769-106/000-036">www.wago.com/769-106/000-036</a>
	<b>Item no.: 769-106/000-037</b> 1-conductor female plug; 4 mm <sup>2</sup> ; 6-pole; 4,00 mm <sup>2</sup> ; green-yellow, gray	<a href="http://www.wago.com/769-106/000-037">www.wago.com/769-106/000-037</a>
	<b>Item no.: 769-106/000-038</b> 1-conductor female plug; 4 mm <sup>2</sup> ; 6-pole; 4,00 mm <sup>2</sup> ; gray, blue, green-yellow	<a href="http://www.wago.com/769-106/000-038">www.wago.com/769-106/000-038</a>
	<b>Item no.: 769-106/000-039</b> 1-conductor female plug; 4 mm <sup>2</sup> ; 6-pole; 4,00 mm <sup>2</sup> ; green-yellow, blue, gray	<a href="http://www.wago.com/769-106/000-039">www.wago.com/769-106/000-039</a>
	<b>Item no.: 769-106/022-000</b> 1-conductor female plug; angled; 4 mm <sup>2</sup> ; 6-pole; 4,00 mm <sup>2</sup> ; gray	<a href="http://www.wago.com/769-106/022-000">www.wago.com/769-106/022-000</a>
	<b>Item no.: 769-107</b> 1-conductor female plug; 4 mm <sup>2</sup> ; 7-pole; 4,00 mm <sup>2</sup> ; gray	<a href="http://www.wago.com/769-107">www.wago.com/769-107</a>
	<b>Item no.: 769-107/000-006</b> 1-conductor female plug; 4 mm <sup>2</sup> ; 7-pole; 4,00 mm <sup>2</sup> ; blue	<a href="http://www.wago.com/769-107/000-006">www.wago.com/769-107/000-006</a>
	<b>Item no.: 769-107/000-036</b> 1-conductor female plug; 4 mm <sup>2</sup> ; 7-pole; 4,00 mm <sup>2</sup> ; gray, green-yellow	<a href="http://www.wago.com/769-107/000-036">www.wago.com/769-107/000-036</a>
	<b>Item no.: 769-107/000-037</b> 1-conductor female plug; 4 mm <sup>2</sup> ; 7-pole; 4,00 mm <sup>2</sup> ; green-yellow, gray	<a href="http://www.wago.com/769-107/000-037">www.wago.com/769-107/000-037</a>
	<b>Item no.: 769-107/000-038</b> 1-conductor female plug; 4 mm <sup>2</sup> ; 7-pole; 4,00 mm <sup>2</sup> ; gray, blue, green-yellow	<a href="http://www.wago.com/769-107/000-038">www.wago.com/769-107/000-038</a>
	<b>Item no.: 769-107/000-039</b> 1-conductor female plug; 4 mm <sup>2</sup> ; 7-pole; 4,00 mm <sup>2</sup> ; green-yellow, blue, gray	<a href="http://www.wago.com/769-107/000-039">www.wago.com/769-107/000-039</a>
	<b>Item no.: 769-107/022-000</b> 1-conductor female plug; angled; 4 mm <sup>2</sup> ; 7-pole; 4,00 mm <sup>2</sup> ; gray	<a href="http://www.wago.com/769-107/022-000">www.wago.com/769-107/022-000</a>

Subject to changes. Please also observe the further product documentation!



**Item no.: 769-108**

1-conductor female plug; 4 mm<sup>2</sup>; 8-pole; 4,00 mm<sup>2</sup>; gray

[www.wago.com/769-108](http://www.wago.com/769-108)



**Item no.: 769-108/000-006**

1-conductor female plug; 4 mm<sup>2</sup>; 8-pole; 4,00 mm<sup>2</sup>; blue

[www.wago.com/769-108/000-006](http://www.wago.com/769-108/000-006)



**Item no.: 769-108/000-036**

1-conductor female plug; 4 mm<sup>2</sup>; 8-pole; 4,00 mm<sup>2</sup>; gray, green-yellow

[www.wago.com/769-108/000-036](http://www.wago.com/769-108/000-036)



**Item no.: 769-108/000-037**

1-conductor female plug; 4 mm<sup>2</sup>; 8-pole; 4,00 mm<sup>2</sup>; green-yellow, gray

[www.wago.com/769-108/000-037](http://www.wago.com/769-108/000-037)



**Item no.: 769-108/000-038**

1-conductor female plug; 4 mm<sup>2</sup>; 8-pole; 4,00 mm<sup>2</sup>; gray, blue, green-yellow

[www.wago.com/769-108/000-038](http://www.wago.com/769-108/000-038)



**Item no.: 769-108/000-039**

1-conductor female plug; 4 mm<sup>2</sup>; 8-pole; 4,00 mm<sup>2</sup>; green-yellow, blue, gray

[www.wago.com/769-108/000-039](http://www.wago.com/769-108/000-039)



**Item no.: 769-108/022-000**

1-conductor female plug; angled; 4 mm<sup>2</sup>; 8-pole; 4,00 mm<sup>2</sup>; gray

[www.wago.com/769-108/022-000](http://www.wago.com/769-108/022-000)



**Item no.: 769-109**

1-conductor female plug; 4 mm<sup>2</sup>; 9-pole; 4,00 mm<sup>2</sup>; gray

[www.wago.com/769-109](http://www.wago.com/769-109)



**Item no.: 769-109/000-006**

1-conductor female plug; 4 mm<sup>2</sup>; 9-pole; 4,00 mm<sup>2</sup>; blue

[www.wago.com/769-109/000-006](http://www.wago.com/769-109/000-006)



**Item no.: 769-109/000-036**

1-conductor female plug; 4 mm<sup>2</sup>; 9-pole; 4,00 mm<sup>2</sup>; gray, green-yellow

[www.wago.com/769-109/000-036](http://www.wago.com/769-109/000-036)



**Item no.: 769-109/000-037**

1-conductor female plug; 4 mm<sup>2</sup>; 9-pole; 4,00 mm<sup>2</sup>; green-yellow, gray

[www.wago.com/769-109/000-037](http://www.wago.com/769-109/000-037)



**Item no.: 769-109/000-038**

1-conductor female plug; 4 mm<sup>2</sup>; 9-pole; 4,00 mm<sup>2</sup>; gray, blue, green-yellow

[www.wago.com/769-109/000-038](http://www.wago.com/769-109/000-038)



**Item no.: 769-109/000-039**

1-conductor female plug; 4 mm<sup>2</sup>; 9-pole; 4,00 mm<sup>2</sup>; green-yellow, blue, gray

[www.wago.com/769-109/000-039](http://www.wago.com/769-109/000-039)



**Item no.: 769-109/022-000**

1-conductor female plug; angled; 4 mm<sup>2</sup>; 9-pole; 4,00 mm<sup>2</sup>; gray

[www.wago.com/769-109/022-000](http://www.wago.com/769-109/022-000)

Subject to changes. Please also observe the further product documentation!

WAGO Kontakttechnik GmbH & Co. KG

Hansastr. 27

32423 Minden

Phone: +49571 887-0 | Fax: +49571 887-169

Email: [info.de@wago.com](mailto:info.de@wago.com) | Web: [www.wago.com](http://www.wago.com)

Do you have any questions about our products?

We are always happy to take your call at 01788 568 008.





**Item no.: 769-110**

1-conductor female plug; 4 mm<sup>2</sup>; 10-pole; 4,00 mm<sup>2</sup>; gray

[www.wago.com/769-110](http://www.wago.com/769-110)



**Item no.: 769-110/000-006**

1-conductor female plug; 4 mm<sup>2</sup>; 10-pole; 4,00 mm<sup>2</sup>; blue

[www.wago.com/769-110/000-006](http://www.wago.com/769-110/000-006)



**Item no.: 769-110/000-036**

1-conductor female plug; 4 mm<sup>2</sup>; 10-pole; 4,00 mm<sup>2</sup>; gray, green-yellow

[www.wago.com/769-110/000-036](http://www.wago.com/769-110/000-036)



**Item no.: 769-110/000-037**

1-conductor female plug; 4 mm<sup>2</sup>; 10-pole; 4,00 mm<sup>2</sup>; green-yellow, gray

[www.wago.com/769-110/000-037](http://www.wago.com/769-110/000-037)



**Item no.: 769-110/000-038**

1-conductor female plug; 4 mm<sup>2</sup>; 10-pole; 4,00 mm<sup>2</sup>; gray, blue, green-yellow

[www.wago.com/769-110/000-038](http://www.wago.com/769-110/000-038)



**Item no.: 769-110/000-039**

1-conductor female plug; 4 mm<sup>2</sup>; 10-pole; 4,00 mm<sup>2</sup>; green-yellow, blue, gray

[www.wago.com/769-110/000-039](http://www.wago.com/769-110/000-039)



**Item no.: 769-110/022-000**

1-conductor female plug; angled; 4 mm<sup>2</sup>; 10-pole; 4,00 mm<sup>2</sup>; gray

[www.wago.com/769-110/022-000](http://www.wago.com/769-110/022-000)



**Item no.: 769-111**

1-conductor female plug; 4 mm<sup>2</sup>; 11-pole; 4,00 mm<sup>2</sup>; gray

[www.wago.com/769-111](http://www.wago.com/769-111)



**Item no.: 769-111/000-006**

1-conductor female plug; 4 mm<sup>2</sup>; 11-pole; 4,00 mm<sup>2</sup>; blue

[www.wago.com/769-111/000-006](http://www.wago.com/769-111/000-006)



**Item no.: 769-111/000-036**

1-conductor female plug; 4 mm<sup>2</sup>; 11-pole; 4,00 mm<sup>2</sup>; gray, green-yellow

[www.wago.com/769-111/000-036](http://www.wago.com/769-111/000-036)



**Item no.: 769-111/000-037**

1-conductor female plug; 4 mm<sup>2</sup>; 11-pole; 4,00 mm<sup>2</sup>; green-yellow, gray

[www.wago.com/769-111/000-037](http://www.wago.com/769-111/000-037)



**Item no.: 769-111/000-038**

1-conductor female plug; 4 mm<sup>2</sup>; 11-pole; 4,00 mm<sup>2</sup>; gray, blue, green-yellow

[www.wago.com/769-111/000-038](http://www.wago.com/769-111/000-038)



**Item no.: 769-111/000-039**

1-conductor female plug; 4 mm<sup>2</sup>; 11-pole; 4,00 mm<sup>2</sup>; green-yellow, blue, gray

[www.wago.com/769-111/000-039](http://www.wago.com/769-111/000-039)



**Item no.: 769-111/022-000**

1-conductor female plug; angled; 4 mm<sup>2</sup>; 11-pole; 4,00 mm<sup>2</sup>; gray

[www.wago.com/769-111/022-000](http://www.wago.com/769-111/022-000)

Subject to changes. Please also observe the further product documentation!

WAGO Kontakttechnik GmbH & Co. KG

Hansastr. 27

32423 Minden

Phone: +49571 887-0 | Fax: +49571 887-169

Email: [info.de@wago.com](mailto:info.de@wago.com) | Web: [www.wago.com](http://www.wago.com)

Do you have any questions about our products?

We are always happy to take your call at 01788 568 008.



**Item no.: 769-112**

1-conductor female plug; 4 mm<sup>2</sup>; 12-pole; 4,00 mm<sup>2</sup>; gray

[www.wago.com/769-112](http://www.wago.com/769-112)



**Item no.: 769-112/000-006**

1-conductor female plug; 4 mm<sup>2</sup>; 12-pole; 4,00 mm<sup>2</sup>; blue

[www.wago.com/769-112/000-006](http://www.wago.com/769-112/000-006)



**Item no.: 769-112/000-036**

1-conductor female plug; 4 mm<sup>2</sup>; 12-pole; 4,00 mm<sup>2</sup>; gray, green-yellow

[www.wago.com/769-112/000-036](http://www.wago.com/769-112/000-036)



**Item no.: 769-112/000-037**

1-conductor female plug; 4 mm<sup>2</sup>; 12-pole; 4,00 mm<sup>2</sup>; green-yellow, gray

[www.wago.com/769-112/000-037](http://www.wago.com/769-112/000-037)



**Item no.: 769-112/000-038**

1-conductor female plug; 4 mm<sup>2</sup>; 12-pole; 4,00 mm<sup>2</sup>; gray, blue, green-yellow

[www.wago.com/769-112/000-038](http://www.wago.com/769-112/000-038)



**Item no.: 769-112/000-039**

1-conductor female plug; 4 mm<sup>2</sup>; 12-pole; 4,00 mm<sup>2</sup>; green-yellow, blue, gray

[www.wago.com/769-112/000-039](http://www.wago.com/769-112/000-039)



**Item no.: 769-112/022-000**

1-conductor female plug; angled; 4 mm<sup>2</sup>; 12-pole; 4,00 mm<sup>2</sup>; gray

[www.wago.com/769-112/022-000](http://www.wago.com/769-112/022-000)



**Item no.: 769-113**

1-conductor female plug; 4 mm<sup>2</sup>; 13-pole; 4,00 mm<sup>2</sup>; gray

[www.wago.com/769-113](http://www.wago.com/769-113)



**Item no.: 769-113/000-036**

1-conductor female plug; 4 mm<sup>2</sup>; 13-pole; 4,00 mm<sup>2</sup>; gray, green-yellow

[www.wago.com/769-113/000-036](http://www.wago.com/769-113/000-036)



**Item no.: 769-113/000-037**

1-conductor female plug; 4 mm<sup>2</sup>; 13-pole; 4,00 mm<sup>2</sup>; green-yellow, gray

[www.wago.com/769-113/000-037](http://www.wago.com/769-113/000-037)



**Item no.: 769-113/000-038**

1-conductor female plug; 4 mm<sup>2</sup>; 13-pole; 4,00 mm<sup>2</sup>; gray, blue, green-yellow

[www.wago.com/769-113/000-038](http://www.wago.com/769-113/000-038)



**Item no.: 769-113/000-039**

1-conductor female plug; 4 mm<sup>2</sup>; 13-pole; 4,00 mm<sup>2</sup>; green-yellow, blue, gray

[www.wago.com/769-113/000-039](http://www.wago.com/769-113/000-039)



**Item no.: 769-113/022-000**

1-conductor female plug; angled; 4 mm<sup>2</sup>; 13-pole; 4,00 mm<sup>2</sup>; gray

[www.wago.com/769-113/022-000](http://www.wago.com/769-113/022-000)



**Item no.: 769-114**

1-conductor female plug; 4 mm<sup>2</sup>; 14-pole; 4,00 mm<sup>2</sup>; gray

[www.wago.com/769-114](http://www.wago.com/769-114)

Subject to changes. Please also observe the further product documentation!

WAGO Kontakttechnik GmbH & Co. KG

Hansastr. 27

32423 Minden

Phone: +49571 887-0 | Fax: +49571 887-169

Email: [info.de@wago.com](mailto:info.de@wago.com) | Web: [www.wago.com](http://www.wago.com)

Do you have any questions about our products?

We are always happy to take your call at 01788 568 008.



**Item no.: 769-114/000-006**  
1-conductor female plug; 4 mm<sup>2</sup>; 14-pole; 4,00 mm<sup>2</sup>; blue

[www.wago.com/769-114/000-006](http://www.wago.com/769-114/000-006)



**Item no.: 769-114/000-036**  
1-conductor female plug; 4 mm<sup>2</sup>; 14-pole; 4,00 mm<sup>2</sup>; gray, green-yellow

[www.wago.com/769-114/000-036](http://www.wago.com/769-114/000-036)



**Item no.: 769-114/000-037**  
1-conductor female plug; 4 mm<sup>2</sup>; 14-pole; 4,00 mm<sup>2</sup>; green-yellow, gray

[www.wago.com/769-114/000-037](http://www.wago.com/769-114/000-037)



**Item no.: 769-114/000-038**  
1-conductor female plug; 4 mm<sup>2</sup>; 14-pole; 4,00 mm<sup>2</sup>; gray, blue, green-yellow

[www.wago.com/769-114/000-038](http://www.wago.com/769-114/000-038)



**Item no.: 769-114/000-039**  
1-conductor female plug; 4 mm<sup>2</sup>; 14-pole; 4,00 mm<sup>2</sup>; green-yellow, blue, gray

[www.wago.com/769-114/000-039](http://www.wago.com/769-114/000-039)



**Item no.: 769-114/022-000**  
1-conductor female plug; angled; 4 mm<sup>2</sup>; 14-pole; 4,00 mm<sup>2</sup>; gray

[www.wago.com/769-114/022-000](http://www.wago.com/769-114/022-000)



**Item no.: 769-115**  
1-conductor female plug; 4 mm<sup>2</sup>; 15-pole; 4,00 mm<sup>2</sup>; gray

[www.wago.com/769-115](http://www.wago.com/769-115)



**Item no.: 769-115/000-036**  
1-conductor female plug; 4 mm<sup>2</sup>; 15-pole; 4,00 mm<sup>2</sup>; gray, green-yellow

[www.wago.com/769-115/000-036](http://www.wago.com/769-115/000-036)



**Item no.: 769-115/000-037**  
1-conductor female plug; 4 mm<sup>2</sup>; 15-pole; 4,00 mm<sup>2</sup>; green-yellow, gray

[www.wago.com/769-115/000-037](http://www.wago.com/769-115/000-037)



**Item no.: 769-115/000-038**  
1-conductor female plug; 4 mm<sup>2</sup>; 15-pole; 4,00 mm<sup>2</sup>; gray, blue, green-yellow

[www.wago.com/769-115/000-038](http://www.wago.com/769-115/000-038)



**Item no.: 769-115/000-039**  
1-conductor female plug; 4 mm<sup>2</sup>; 15-pole; 4,00 mm<sup>2</sup>; green-yellow, blue, gray

[www.wago.com/769-115/000-039](http://www.wago.com/769-115/000-039)



**Item no.: 769-115/022-000**  
1-conductor female plug; angled; 4 mm<sup>2</sup>; 15-pole; 4,00 mm<sup>2</sup>; gray

[www.wago.com/769-115/022-000](http://www.wago.com/769-115/022-000)



**Item no.: 769-121**  
2-conductor female connector; 4 mm<sup>2</sup>; 1-pole; 4,00 mm<sup>2</sup>; gray

















[www.wago.com/769-121](http://www.wago.com/769-121)

















**Item no.: 769-121/000-016**  
2-conductor female connector; 4 mm<sup>2</sup>; 1-pole; 4,00 mm<sup>2</sup>; green-yellow

[www.wago.com/769-121/000-016](http://www.wago.com/769-121/000-016)

Subject to changes. Please also observe the further product documentation!

	<b>Item no.: 769-122</b> 2-conductor female connector; 4 mm <sup>2</sup> ; 2-pole; 4,00 mm <sup>2</sup> ; gray	<a href="http://www.wago.com/769-122">www.wago.com/769-122</a>
	<b>Item no.: 769-123</b> 2-conductor female connector; 4 mm <sup>2</sup> ; 3-pole; 4,00 mm <sup>2</sup> ; gray	<a href="http://www.wago.com/769-123">www.wago.com/769-123</a>
	<b>Item no.: 769-124</b> 2-conductor female connector; 4 mm <sup>2</sup> ; 4-pole; 4,00 mm <sup>2</sup> ; gray	<a href="http://www.wago.com/769-124">www.wago.com/769-124</a>
	<b>Item no.: 769-125</b> 2-conductor female connector; 4 mm <sup>2</sup> ; 5-pole; 4,00 mm <sup>2</sup> ; gray	<a href="http://www.wago.com/769-125">www.wago.com/769-125</a>
	<b>Item no.: 769-126</b> 2-conductor female connector; 4 mm <sup>2</sup> ; 6-pole; 4,00 mm <sup>2</sup> ; gray	<a href="http://www.wago.com/769-126">www.wago.com/769-126</a>
	<b>Item no.: 769-127</b> 2-conductor female connector; 4 mm <sup>2</sup> ; 7-pole; 4,00 mm <sup>2</sup> ; gray	<a href="http://www.wago.com/769-127">www.wago.com/769-127</a>
	<b>Item no.: 769-128</b> 2-conductor female connector; 4 mm <sup>2</sup> ; 8-pole; 4,00 mm <sup>2</sup> ; gray	<a href="http://www.wago.com/769-128">www.wago.com/769-128</a>
	<b>Item no.: 769-129</b> 2-conductor female connector; 4 mm <sup>2</sup> ; 9-pole; 4,00 mm <sup>2</sup> ; gray	<a href="http://www.wago.com/769-129">www.wago.com/769-129</a>
	<b>Item no.: 769-130</b> 2-conductor female connector; 4 mm <sup>2</sup> ; 10-pole; 4,00 mm <sup>2</sup> ; gray	<a href="http://www.wago.com/769-130">www.wago.com/769-130</a>
	<b>Item no.: 769-131</b> 2-conductor female connector; 4 mm <sup>2</sup> ; 11-pole; 4,00 mm <sup>2</sup> ; gray	<a href="http://www.wago.com/769-131">www.wago.com/769-131</a>
	<b>Item no.: 769-132</b> 2-conductor female connector; 4 mm <sup>2</sup> ; 12-pole; 4,00 mm <sup>2</sup> ; gray	<a href="http://www.wago.com/769-132">www.wago.com/769-132</a>
	<b>Item no.: 769-133</b> 2-conductor female connector; 4 mm <sup>2</sup> ; 13-pole; 4,00 mm <sup>2</sup> ; gray	<a href="http://www.wago.com/769-133">www.wago.com/769-133</a>
	<b>Item no.: 769-134</b> 2-conductor female connector; 4 mm <sup>2</sup> ; 14-pole; 4,00 mm <sup>2</sup> ; gray	<a href="http://www.wago.com/769-134">www.wago.com/769-134</a>
	<b>Item no.: 769-135</b> 2-conductor female connector; 4 mm <sup>2</sup> ; 15-pole; 4,00 mm <sup>2</sup> ; gray	<a href="http://www.wago.com/769-135">www.wago.com/769-135</a>
	<b>Item no.: 769-501</b> Start module for 1-conductor female connector; with integrated end plate; 4 mm <sup>2</sup> ; 1-pole; 4,00 mm <sup>2</sup> ; gray	<a href="http://www.wago.com/769-501">www.wago.com/769-501</a>
	<b>Item no.: 769-501/000-006</b> Start module for 1-conductor female connector; 4 mm <sup>2</sup> ; 1-pole; 4,00 mm <sup>2</sup> ; blue	<a href="http://www.wago.com/769-501/000-006">www.wago.com/769-501/000-006</a>
	<b>Item no.: 769-501/000-016</b> Start module for 1-conductor female connector; with integrated end plate; 4 mm <sup>2</sup> ; 1-pole; 4,00 mm <sup>2</sup> ; green-yellow	<a href="http://www.wago.com/769-501/000-016">www.wago.com/769-501/000-016</a>

Subject to changes. Please also observe the further product documentation!

	<b>Item no.: 769-502</b> Center module for 1-conductor female connector; 4 mm <sup>2</sup> ; 1-pole; 4,00 mm <sup>2</sup> ; gray	<a href="http://www.wago.com/769-502">www.wago.com/769-502</a>
	<b>Item no.: 769-502/000-006</b> Center module for 1-conductor female connector; 4 mm <sup>2</sup> ; 1-pole; 4,00 mm <sup>2</sup> ; blue	<a href="http://www.wago.com/769-502/000-006">www.wago.com/769-502/000-006</a>
	<b>Item no.: 769-502/000-016</b> Center module for 1-conductor female connector; 4 mm <sup>2</sup> ; 1-pole; 4,00 mm <sup>2</sup> ; green-yellow	<a href="http://www.wago.com/769-502/000-016">www.wago.com/769-502/000-016</a>
	<b>Item no.: 769-503</b> End module for 1-conductor female connector; 4 mm <sup>2</sup> ; 1-pole; 4,00 mm <sup>2</sup> ; gray	<a href="http://www.wago.com/769-503">www.wago.com/769-503</a>
	<b>Item no.: 769-503/000-006</b> End module for 1-conductor female connector; 4 mm <sup>2</sup> ; 1-pole; 4,00 mm <sup>2</sup> ; blue	<a href="http://www.wago.com/769-503/000-006">www.wago.com/769-503/000-006</a>
	<b>Item no.: 769-503/000-016</b> End module for 1-conductor female connector; 4 mm <sup>2</sup> ; 1-pole; 4,00 mm <sup>2</sup> ; green-yellow	<a href="http://www.wago.com/769-503/000-016">www.wago.com/769-503/000-016</a>
	<b>Item no.: 769-504</b> Start module for 2-conductor female connector; with integrated end plate; 4 mm <sup>2</sup> ; 1-pole; 4,00 mm <sup>2</sup> ; gray	<a href="http://www.wago.com/769-504">www.wago.com/769-504</a>
	<b>Item no.: 769-504/000-006</b> Start module for 2-conductor female connector; with integrated end plate; 4 mm <sup>2</sup> ; 1-pole; 4,00 mm <sup>2</sup> ; blue	<a href="http://www.wago.com/769-504/000-006">www.wago.com/769-504/000-006</a>
	<b>Item no.: 769-504/000-016</b> Start module for 2-conductor female connector; 4 mm <sup>2</sup> ; 1-pole; 4,00 mm <sup>2</sup> ; green-yellow	<a href="http://www.wago.com/769-504/000-016">www.wago.com/769-504/000-016</a>
	<b>Item no.: 769-505</b> Center module for 2-conductor female connector; 4 mm <sup>2</sup> ; 1-pole; 4,00 mm <sup>2</sup> ; gray	<a href="http://www.wago.com/769-505">www.wago.com/769-505</a>
	<b>Item no.: 769-505/000-006</b> Center module for 2-conductor female connector; 4 mm <sup>2</sup> ; 1-pole; 4,00 mm <sup>2</sup> ; blue	<a href="http://www.wago.com/769-505/000-006">www.wago.com/769-505/000-006</a>
	<b>Item no.: 769-505/000-016</b> Center module for 2-conductor female connector; 4 mm <sup>2</sup> ; 1-pole; 4,00 mm <sup>2</sup> ; green-yellow	<a href="http://www.wago.com/769-505/000-016">www.wago.com/769-505/000-016</a>
	<b>Item no.: 769-506</b> End module for 2-conductor female connector; 4 mm <sup>2</sup> ; 1-pole; 4,00 mm <sup>2</sup> ; gray	<a href="http://www.wago.com/769-506">www.wago.com/769-506</a>
	<b>Item no.: 769-506/000-006</b> End module for 2-conductor female connector; 4 mm <sup>2</sup> ; 1-pole; 4,00 mm <sup>2</sup> ; blue	<a href="http://www.wago.com/769-506/000-006">www.wago.com/769-506/000-006</a>
	<b>Item no.: 769-506/000-016</b> End module for 2-conductor female connector; 4 mm <sup>2</sup> ; 1-pole; 4,00 mm <sup>2</sup> ; green-yellow	<a href="http://www.wago.com/769-506/000-016">www.wago.com/769-506/000-016</a>

Subject to changes. Please also observe the further product documentation!



**Item no.: 769-512**

Start module for 1-conductor female connector; angled; 4 mm<sup>2</sup>; 1-pole; 4,00 mm<sup>2</sup>; gray

[www.wago.com/769-512](http://www.wago.com/769-512)

**Item no.: 769-512/000-006**

Start module for 1-conductor female connector; angled; 4 mm<sup>2</sup>; 1-pole; 4,00 mm<sup>2</sup>; blue

[www.wago.com/769-512/000-006](http://www.wago.com/769-512/000-006)

**Item no.: 769-512/000-016**

Start module for 1-conductor female connector; angled; 4 mm<sup>2</sup>; 1-pole; 4,00 mm<sup>2</sup>; green-yellow

[www.wago.com/769-512/000-016](http://www.wago.com/769-512/000-016)

**Item no.: 769-513**

Center module for 1-conductor female connector; angled; 4 mm<sup>2</sup>; 1-pole; 4,00 mm<sup>2</sup>; gray

[www.wago.com/769-513](http://www.wago.com/769-513)

**Item no.: 769-513/000-006**

Center module for 1-conductor female connector; angled; 4 mm<sup>2</sup>; 1-pole; 4,00 mm<sup>2</sup>; blue

[www.wago.com/769-513/000-006](http://www.wago.com/769-513/000-006)

**Item no.: 769-513/000-016**

Center module for 1-conductor female connector; angled; 4 mm<sup>2</sup>; 1-pole; 4,00 mm<sup>2</sup>; green-yellow

[www.wago.com/769-513/000-016](http://www.wago.com/769-513/000-016)

**Item no.: 769-515**

End module for 1-conductor female connector; angled; 4 mm<sup>2</sup>; 1-pole; 4,00 mm<sup>2</sup>; gray

[www.wago.com/769-515](http://www.wago.com/769-515)

**Item no.: 769-515/000-006**

End module for 1-conductor female connector; angled; 4 mm<sup>2</sup>; 1-pole; 4,00 mm<sup>2</sup>; blue

[www.wago.com/769-515/000-006](http://www.wago.com/769-515/000-006)

**Item no.: 769-515/000-016**

End module for 1-conductor female connector; angled; 4 mm<sup>2</sup>; 1-pole; 4,00 mm<sup>2</sup>; green-yellow

[www.wago.com/769-515/000-016](http://www.wago.com/769-515/000-016)

#### Push-In type wire jumper



**Item no.: 249-123**

Push-in type wire jumper; 0.75 mm<sup>2</sup>; insulated; 180 mm long; black

[www.wago.com/249-123](http://www.wago.com/249-123)



**Item no.: 249-125**

Push-in type wire jumper; insulated; 60 mm long; black

[www.wago.com/249-125](http://www.wago.com/249-125)



**Item no.: 249-126**

Push-in type wire jumper; 0.75 mm<sup>2</sup>; insulated; 110 mm long; black

[www.wago.com/249-126](http://www.wago.com/249-126)



**Item no.: 249-127**

Push-in type wire jumper; 0.75 mm<sup>2</sup>; insulated; 250 mm long; black

[www.wago.com/249-127](http://www.wago.com/249-127)

#### Carrier rail



**Item no.: 210-112**

Steel carrier rail; 35 x 7.5 mm; 1 mm thick; 2 m long; slotted; according to EN 60715; "Hole width 25 mm; silver-colored" [www.wago.com/210-112](http://www.wago.com/210-112)

Subject to changes. Please also observe the further product documentation!

WAGO Kontakttechnik GmbH & Co. KG

Hansastr. 27















32423 Minden

Phone: +49571 887-0 | Fax: +49571 887-169

Email: [info.de@wago.com](mailto:info.de@wago.com) | Web: [www.wago.com](http://www.wago.com)

Do you have any questions about our products?















We are always happy to take your call at 01788 568 008.

	<b>Item no.: 210-113</b> Steel carrier rail; 35 x 7.5 mm; 1 mm thick; 2 m long; unslotted; according to EN 60715; silver-colored	<a href="http://www.wago.com/210-113">www.wago.com/210-113</a>
	<b>Item no.: 210-114</b> Steel carrier rail; 35 x 15 mm; 1.5 mm thick; 2 m long; unslotted; similar to EN 60715; silver-colored	<a href="http://www.wago.com/210-114">www.wago.com/210-114</a>
	<b>Item no.: 210-115</b> Steel carrier rail; 35 x 7.5 mm; 1 mm thick; 2 m long; slotted; according to EN 60715; "Hole width 18 mm; silver-colored	<a href="http://www.wago.com/210-115">www.wago.com/210-115</a>
	<b>Item no.: 210-118</b> Steel carrier rail; 35 x 15 mm; 2.3 mm thick; 2 m long; unslotted; according to EN 60715; silver-colored	<a href="http://www.wago.com/210-118">www.wago.com/210-118</a>
	<b>Item no.: 210-196</b> Aluminum carrier rail; 35 x 8.2 mm; 1.6 mm thick; 2 m long; unslotted; similar to EN 60715; silver-colored	<a href="http://www.wago.com/210-196">www.wago.com/210-196</a>
	<b>Item no.: 210-197</b> Steel carrier rail; 35 x 15 mm; 1.5 mm thick; 2 m long; slotted; similar to EN 60715; silver-colored	<a href="http://www.wago.com/210-197">www.wago.com/210-197</a>
	<b>Item no.: 210-198</b> Copper carrier rail; 35 x 15 mm; 2.3 mm thick; 2 m long; unslotted; according to EN 60715; copper-colored	<a href="http://www.wago.com/210-198">www.wago.com/210-198</a>
	<b>Item no.: 210-504</b> Steel carrier rail; 35 x 7.5 mm; 1 mm thick; 2 m long; slotted; galvanized; according to EN 60715; silver-colored	<a href="http://www.wago.com/210-504">www.wago.com/210-504</a>
	<b>Item no.: 210-505</b> Steel carrier rail; 35 x 7.5 mm; 1 mm thick; 2 m long; unslotted; galvanized; according to EN 60715; silver-colored	<a href="http://www.wago.com/210-505">www.wago.com/210-505</a>
	<b>Item no.: 210-506</b> Steel carrier rail; 35 x 15 mm; 1.5 mm thick; 2 m long; unslotted; galvanized; similar to EN 60715; silver-colored	<a href="http://www.wago.com/210-506">www.wago.com/210-506</a>
	<b>Item no.: 210-508</b> Steel carrier rail; 35 x 15 mm; 1.5 mm thick; 2 m long; slotted; galvanized; similar to EN 60715; silver-colored	<a href="http://www.wago.com/210-508">www.wago.com/210-508</a>
<b>check</b>		
	<b>Item no.: 210-137</b> Test plug; 2.3 mm Ø; with 500 mm cable; yellow	<a href="http://www.wago.com/210-137">www.wago.com/210-137</a>
	<b>Item no.: 280-404</b> Test plug adapter; 5 mm wide; for test plug (2.3 mm Ø); suitable for 1.5 mm <sup>2</sup> - 4 mm <sup>2</sup> tbs; gray	<a href="http://www.wago.com/280-404">www.wago.com/280-404</a>
	<b>Item no.: 280-418</b> Test plug module; modular; suitable for all WAGO 280 and 780 Series rail-mounted terminal blocks with jumper slots in the current bar; gray	<a href="http://www.wago.com/280-418">www.wago.com/280-418</a>
	<b>Item no.: 280-419</b> Spacer module; modular; bridging commoned terminal blocks; gray	<a href="http://www.wago.com/280-419">www.wago.com/280-419</a>

**Marking accessories**

	<b>Item no.: 2009-145</b> Mini-WSB Inline; for Smart Printer; 1700 pieces on roll; stretchable 5 - 5.2 mm; plain; snap-on type; white	<a href="http://www.wago.com/2009-145">www.wago.com/2009-145</a>
	<b>Item no.: 2009-145/000-002</b>	

Subject to changes. Please also observe the further product documentation!

	Mini-WSB Inline; for Smart Printer; 1700 pieces on roll; stretchable 5 - 5.2 mm; plain; snap-on type; yellow	<a href="http://www.wago.com/2009-145/000-002">www.wago.com/2009-145/000-002</a>
	<b>Item no.: 2009-145/000-005</b> Mini-WSB Inline; for Smart Printer; 1700 pieces on roll; stretchable 5 - 5.2 mm; plain; snap-on type; red	<a href="http://www.wago.com/2009-145/000-005">www.wago.com/2009-145/000-005</a>
	<b>Item no.: 2009-145/000-006</b> Mini-WSB Inline; for Smart Printer; 1700 pieces on roll; stretchable 5 - 5.2 mm; plain; snap-on type; blue	<a href="http://www.wago.com/2009-145/000-006">www.wago.com/2009-145/000-006</a>
	<b>Item no.: 2009-145/000-007</b> Mini-WSB Inline; for Smart Printer; 1700 pieces on roll; stretchable 5 - 5.2 mm; plain; snap-on type; gray	<a href="http://www.wago.com/2009-145/000-007">www.wago.com/2009-145/000-007</a>
	<b>Item no.: 2009-145/000-012</b> Mini-WSB Inline; for Smart Printer; 1700 pieces on roll; stretchable 5 - 5.2 mm; plain; snap-on type; orange	<a href="http://www.wago.com/2009-145/000-012">www.wago.com/2009-145/000-012</a>
	<b>Item no.: 2009-145/000-023</b> Mini-WSB Inline; for Smart Printer; 1700 pieces on roll; stretchable 5 - 5.2 mm; plain; snap-on type; green	<a href="http://www.wago.com/2009-145/000-023">www.wago.com/2009-145/000-023</a>
	<b>Item no.: 2009-145/000-024</b> Mini-WSB Inline; for Smart Printer; 1700 pieces on roll; stretchable 5 - 5.2 mm; plain; snap-on type; violet	<a href="http://www.wago.com/2009-145/000-024">www.wago.com/2009-145/000-024</a>
	<b>Item no.: 248-501</b> Miniature WSB Quick marking system; plain; Marker width 5 mm; 10 strips with 10 markers per card	<a href="http://www.wago.com/248-501">www.wago.com/248-501</a>
	<b>Item no.: 248-501/000-002</b> Mini-WSB marking card; as card; not stretchable; plain; snap-on type; yellow	<a href="http://www.wago.com/248-501/000-002">www.wago.com/248-501/000-002</a>
	<b>Item no.: 248-501/000-005</b> Mini-WSB marking card; as card; not stretchable; plain; snap-on type; red	<a href="http://www.wago.com/248-501/000-005">www.wago.com/248-501/000-005</a>
	<b>Item no.: 248-501/000-006</b> Mini-WSB marking card; as card; not stretchable; plain; snap-on type; blue	<a href="http://www.wago.com/248-501/000-006">www.wago.com/248-501/000-006</a>
	<b>Item no.: 248-501/000-007</b> Mini-WSB marking card; as card; not stretchable; plain; snap-on type; gray	<a href="http://www.wago.com/248-501/000-007">www.wago.com/248-501/000-007</a>
	<b>Item no.: 248-501/000-012</b> Mini-WSB marking card; as card; not stretchable; plain; snap-on type; orange	<a href="http://www.wago.com/248-501/000-012">www.wago.com/248-501/000-012</a>
	<b>Item no.: 248-501/000-017</b> Mini-WSB marking card; as card; not stretchable; plain; snap-on type; light green	<a href="http://www.wago.com/248-501/000-017">www.wago.com/248-501/000-017</a>

Subject to changes. Please also observe the further product documentation!





Item no.: 248-501/000-023

Mini-WSB marking card; as card; not stretchable; plain; snap-on type; green

[www.wago.com/248-501/000-023](http://www.wago.com/248-501/000-023)



Item no.: 248-501/000-024

Mini-WSB marking card; as card; not stretchable; plain; snap-on type; violet

[www.wago.com/248-501/000-024](http://www.wago.com/248-501/000-024)

tools



Item no.: 210-720

Operating tool; Blade: 3.5 x 0.5 mm; with a partially insulated shaft; multicoloured

[www.wago.com/210-720](http://www.wago.com/210-720)

Downloads

Documentation

Bid Text

769-209/281-413 doc - Datei	2. 10. 2017	doc 24.1 kB	Download
--------------------------------	-------------	----------------	----------

769-209/281-413 X81 - Datei	19. 2. 2019	xml 3.0 kB	Download
--------------------------------	-------------	---------------	----------

Additional Information

Technical explanations	3. 4. 2019	pdf 2.2 MB	Download
------------------------	------------	---------------	----------

CAD/CAE-Data

CAD data

2D/3D Models 769-209/281-413	URL	Download
------------------------------	-----	----------

CAE data

EPLAN Data Portal 769-209/281-413	URL	Download
-----------------------------------	-----	----------

WSCAD Universe 769-209/281-413	URL	Download
--------------------------------	-----	----------

ZUKEN Portal 769-209/281-413	URL	Download
------------------------------	-----	----------

EPLAN Data Portal 769-209/281-413	URL	Download
-----------------------------------	-----	----------

WSCAD Universe 769-209/281-413	URL	Download
--------------------------------	-----	----------

Subject to changes. Please also observe the further product documentation!

WAGO Kontakttechnik GmbH & Co. KG  
 Hansastr. 27  
 32423 Minden  
 Phone: +49571 887-0 | Fax: +49571 887-169  
 Email: [info.de@wago.com](mailto:info.de@wago.com) | Web: [www.wago.com](http://www.wago.com)

Do you have any questions about our products?  
 We are always happy to take your call at 01788 568 008.

## Environmental Product Compliance

### Compliance Search

Environmental Product Compliance 769-209/281-413

URL

Download

2-pin component carrier block; with 2 jumper positions; LED (red); 24 VDC; for DIN-rail  
35 x 15 and 35 x 7.5; gray

## Installation Notes

### Installation

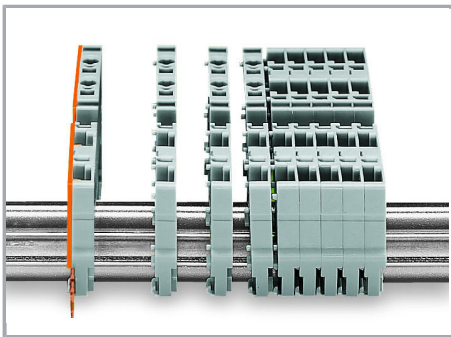

Snap individual carrier terminal blocks onto the DIN-rail and slide together.

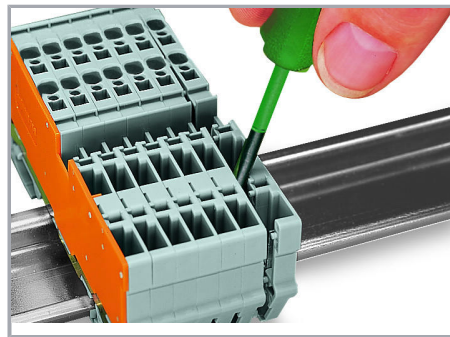

Open the assembly by laterally sliding a block via operating tool and remove terminal block via release lever.

### Commoning

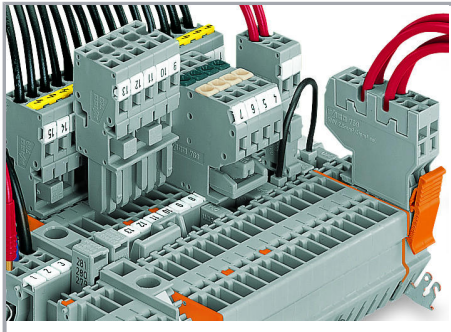

Commoning with adjacent or staggered jumpers.

Push jumpers down until fully inserted.

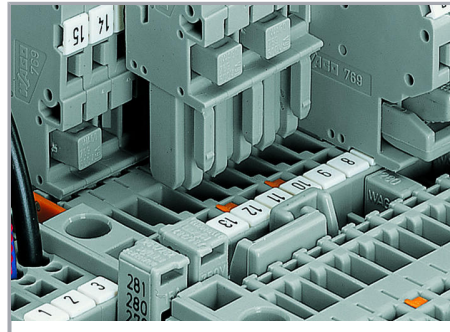

Commoning carrier terminal blocks via staggered jumpers.

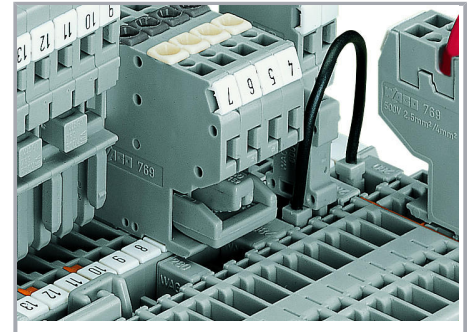

Commoning a 2-conductor female plug via staggered jumper and carrier terminal blocks via adjacent jumpers.

Subject to changes. Please also observe the further product documentation!

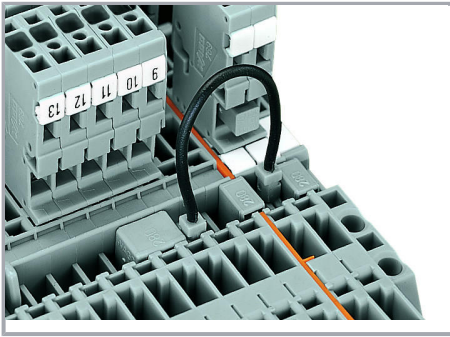

Commoning carrier terminal blocks via push-in type wire jumpers or adjacent jumpers – even over an intermediate plate.

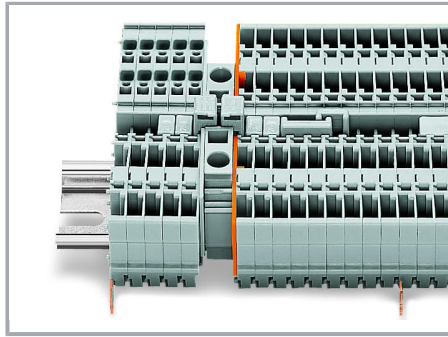

Commoning “supply terminal blocks” (up to 10 mm<sup>2</sup>/8 AWG) with carrier terminal blocks via step-down jumpers.

### Testing

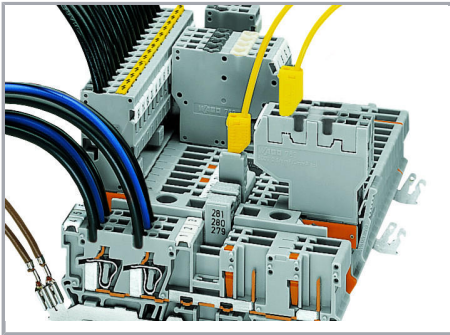

Testing with a 2.3 mm Ø test plug (max. 42 V).

### Coding

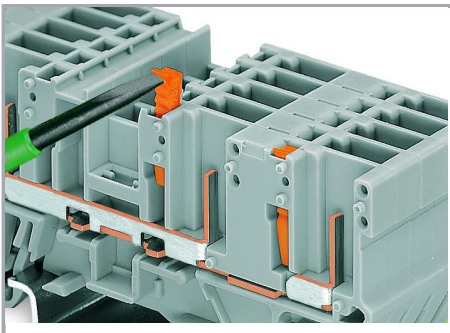

Snap coding pin in proper direction on carrier terminal block.

Shown: Coding pin removal from carrier terminal block.

### Locking system

Subject to changes. Please also observe the further product documentation!

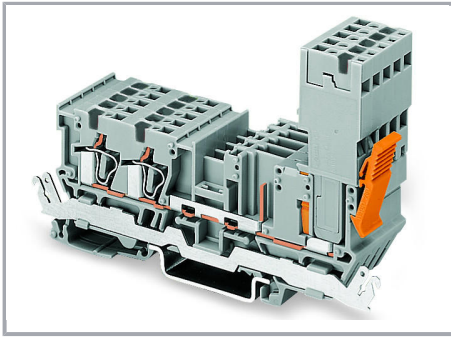

Securing a female plug via locking lever on the terminal block side.

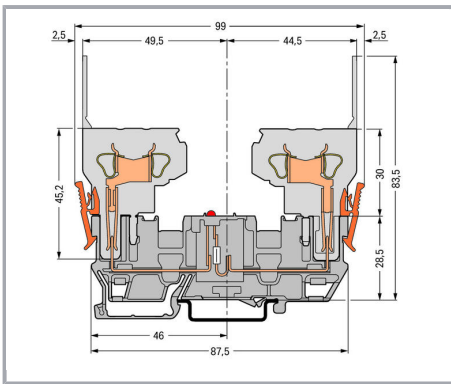

LED carrier terminal block

For other dimensions, see carrier terminal block (769-151).

Subject to changes. Please also observe the further product documentation!

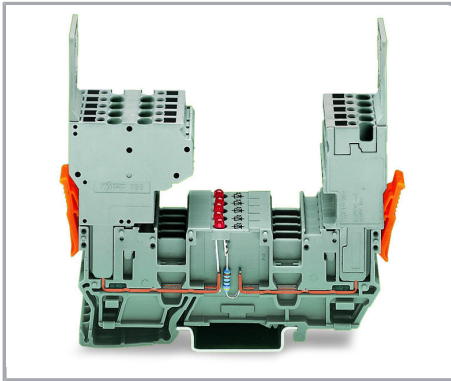

2-conductor and 1-conductor female plugs  
(may be reversed)

LED carrier terminal blocks can be  
commoned via 280 and 780 Series Jumpers  
and tested using a test plug adapter (280-4..).

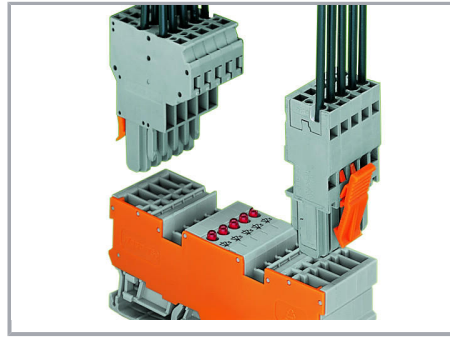

2-pin LED carrier terminal block with 2  
jumper positions

2-conductor female connector

1-conductor female plug, straight

## Product family

**X-COM**

[Show all products from the family](#)

Subject to changes. Please also observe the further product documentation!