

## Data sheet | Item number: 280-944/281-589

Component terminal block; double-deck; with end plate; with 1.5KE33C TVS diode; 24 VDC; for DIN-rail 35 x 15 and 35 x 7.5; 2.5 mm<sup>2</sup>; CAGE CLAMP®; 2,50 mm<sup>2</sup>; gray

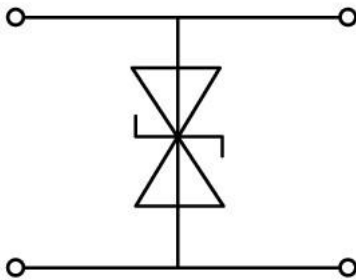

[www.wago.com/280-944/281-589](http://www.wago.com/280-944/281-589)

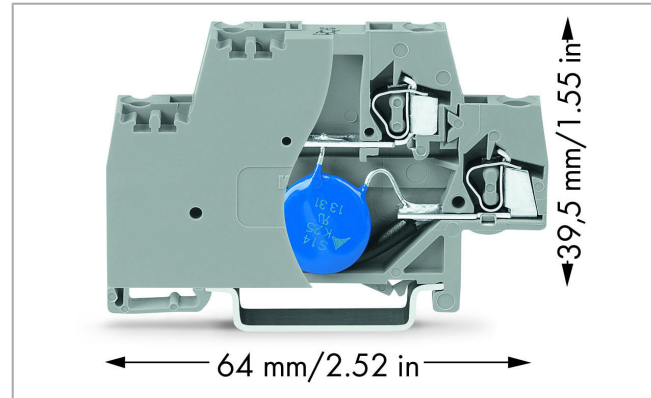
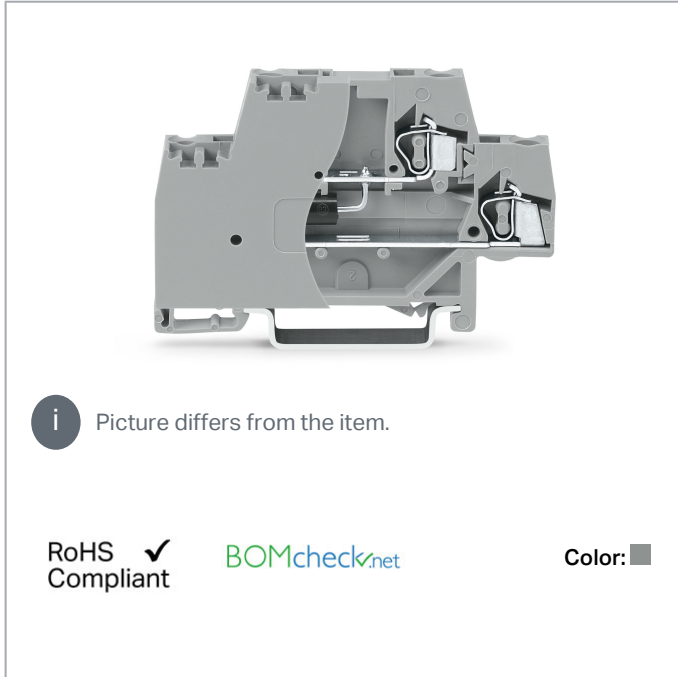

### Item description

#### Short description:

This component terminal block with surge suppression device and end plate is equipped with a TVS diode.

#### Features:

- Protect your system against overvoltage
- Slim, space-saving design
- Control operational costs by preventing expensive, unplanned downtime

Subject to changes. Please also observe the further product documentation!

WAGO Kontakttechnik GmbH & Co. KG  
Hansastr. 27  
32423 Minden  
Phone: +49571 887-0 | Fax: +49571 887-169  
Email: [info.de@wago.com](mailto:info.de@wago.com) | Web: [www.wago.com](http://www.wago.com)

Do you have any questions about our products?  
We are always happy to take your call at +49 (571) 887-44222.



- High operational reliability and system uptime

## Data

### Electrical data

Nominal operating voltage	DC 24 V
Continuous operating voltage (max.)	DC 28 V
Rated continuous current	20 A
Nominal discharge current (8/20 $\mu$ s), line	169 A
Protection level (8/20 $\mu$ s)	$\leq$ DC 59 V
Response time (line/line)	$\leq$
Capacitance	$\leq$ 2.7 nF

### Connection data

Connection points (number)	4
Connection technology	CAGE CLAMP®
Solid conductor	0.08 ... 2.5 mm <sup>2</sup> / 28 ... 14 AWG
Fine-stranded conductor	0.08 ... 2.5 mm <sup>2</sup> / 28 ... 14 AWG
Strip length	8 ... 9 mm / 0.31 ... 0.35 inch

### Physical data

Width	10 mm / 0.394 inch
Height from upper-edge of DIN-rail	39.5 mm / 1.555 inch
Depth	64 mm / 2.52 inch

### Mechanical data

Design	with end plate
Mounting type	DIN-35 rail

### Material data

Color	gray
Fire load	0.265 MJ
Weight	13.6 g

### Commercial data







Product Group	1 (Rail Mounted Terminal Blocks)
---------------	----------------------------------

Subject to changes. Please also observe the further product documentation!

Packaging type	BOX
Country of origin	DE
GTIN	4050821515081
Customs tariff number	85369010000

## Compatible products



### Jumper

	<b>Item no.: 280-482</b> Jumper; 2-way; insulated; gray	<a href="http://www.wago.com/280-482">www.wago.com/280-482</a>
	<b>Item no.: 280-483</b> Jumper; 3-way; insulated; gray	<a href="http://www.wago.com/280-483">www.wago.com/280-483</a>
	<b>Item no.: 280-484</b> Jumper; 4-way; insulated; gray	<a href="http://www.wago.com/280-484">www.wago.com/280-484</a>
	<b>Item no.: 280-485</b> Jumper; 5-way; insulated; gray	<a href="http://www.wago.com/280-485">www.wago.com/280-485</a>
	<b>Item no.: 280-490</b> Jumper; 10-way; insulated; gray	<a href="http://www.wago.com/280-490">www.wago.com/280-490</a>
	<b>Item no.: 280-492</b> Jumper; 2-way; insulated; gray	<a href="http://www.wago.com/280-492">www.wago.com/280-492</a>

### tools













	<b>Item no.: 210-720</b> Operating tool; Blade: 3.5 x 0.5 mm; with a partially insulated shaft; multicoloured	<a href="http://www.wago.com/210-720">www.wago.com/210-720</a>
--	--	--

### Marking accessories



	<b>Item no.: 2009-145</b> Mini-WSB Inline; for Smart Printer; 1700 pieces on roll; stretchable 5 - 5.2 mm; plain; snap-on type; white	<a href="http://www.wago.com/2009-145">www.wago.com/2009-145</a>
	<b>Item no.: 2009-145/000-002</b> Mini-WSB Inline; for Smart Printer; 1700 pieces on roll; stretchable 5 - 5.2 mm; plain; snap-on type; yellow	<a href="http://www.wago.com/2009-145/000-002">www.wago.com/2009-145/000-002</a>
	<b>Item no.: 2009-145/000-005</b> Mini-WSB Inline; for Smart Printer; 1700 pieces on roll; stretchable 5 - 5.2 mm; plain; snap-on type; red	<a href="http://www.wago.com/2009-145/000-005">www.wago.com/2009-145/000-005</a>
	<b>Item no.: 2009-145/000-006</b> Mini-WSB Inline; for Smart Printer; 1700 pieces on roll; stretchable 5 - 5.2 mm; plain; snap-on type; blue	<a href="http://www.wago.com/2009-145/000-006">www.wago.com/2009-145/000-006</a>
	<b>Item no.: 2009-145/000-007</b> Mini-WSB Inline; for Smart Printer; 1700 pieces on roll; stretchable 5 - 5.2 mm; plain; snap-on type; gray	<a href="http://www.wago.com/2009-145/000-007">www.wago.com/2009-145/000-007</a>

**Item no.: 2009-145/000-012**

Subject to changes. Please also observe the further product documentation!

	Mini-WSB Inline; for Smart Printer; 1700 pieces on roll; stretchable 5 - 5.2 mm; plain; snap-on type; orange	<a href="http://www.wago.com/2009-145/000-012">www.wago.com/2009-145/000-012</a>
	<b>Item no.: 2009-145/000-023</b> Mini-WSB Inline; for Smart Printer; 1700 pieces on roll; stretchable 5 - 5.2 mm; plain; snap-on type; green	<a href="http://www.wago.com/2009-145/000-023">www.wago.com/2009-145/000-023</a>
	<b>Item no.: 2009-145/000-024</b> Mini-WSB Inline; for Smart Printer; 1700 pieces on roll; stretchable 5 - 5.2 mm; plain; snap-on type; violet	<a href="http://www.wago.com/2009-145/000-024">www.wago.com/2009-145/000-024</a>
	<b>Item no.: 248-501</b> Miniature WSB Quick marking system; plain; Marker width 5 mm; 10 strips with 10 markers per card	<a href="http://www.wago.com/248-501">www.wago.com/248-501</a>
	<b>Item no.: 248-501/000-002</b> Mini-WSB marking card; as card; not stretchable; plain; snap-on type; yellow	<a href="http://www.wago.com/248-501/000-002">www.wago.com/248-501/000-002</a>
	<b>Item no.: 248-501/000-005</b> Mini-WSB marking card; as card; not stretchable; plain; snap-on type; red	<a href="http://www.wago.com/248-501/000-005">www.wago.com/248-501/000-005</a>
	<b>Item no.: 248-501/000-006</b> Mini-WSB marking card; as card; not stretchable; plain; snap-on type; blue	<a href="http://www.wago.com/248-501/000-006">www.wago.com/248-501/000-006</a>
	<b>Item no.: 248-501/000-007</b> Mini-WSB marking card; as card; not stretchable; plain; snap-on type; gray	<a href="http://www.wago.com/248-501/000-007">www.wago.com/248-501/000-007</a>
	<b>Item no.: 248-501/000-012</b> Mini-WSB marking card; as card; not stretchable; plain; snap-on type; orange	<a href="http://www.wago.com/248-501/000-012">www.wago.com/248-501/000-012</a>
	<b>Item no.: 248-501/000-017</b> Mini-WSB marking card; as card; not stretchable; plain; snap-on type; light green	<a href="http://www.wago.com/248-501/000-017">www.wago.com/248-501/000-017</a>
	<b>Item no.: 248-501/000-023</b> Mini-WSB marking card; as card; not stretchable; plain; snap-on type; green	<a href="http://www.wago.com/248-501/000-023">www.wago.com/248-501/000-023</a>
	<b>Item no.: 248-501/000-024</b> Mini-WSB marking card; as card; not stretchable; plain; snap-on type; violet	<a href="http://www.wago.com/248-501/000-024">www.wago.com/248-501/000-024</a>

#### Insulation stop

	<b>Item no.: 280-470</b> Insulation stop; 0.08 - 0.2 mm <sup>2</sup> "s" (0.14 mm <sup>2</sup> "f-st"); 5 pieces/strip; white	<a href="http://www.wago.com/280-470">www.wago.com/280-470</a>
	<b>Item no.: 280-471</b> Insulation stop; 0.25 - 0.5 mm <sup>2</sup> ; 5 pieces/strip; light gray	<a href="http://www.wago.com/280-471">www.wago.com/280-471</a>

Subject to changes. Please also observe the further product documentation!



Item no.: 280-472  
Insulation stop; 0.75 - 1 mm<sup>2</sup>; 5 pieces/strip

[www.wago.com/280-472](http://www.wago.com/280-472)

## Downloads

### Documentation

#### Bid Text

280-944/281-589 doc - Datei	11. 2. 2015	doc 26.1 kB	Download
280-944/281-589 X81 - Datei	19. 2. 2019	xml 3.3 kB	Download

#### Additional Information

Disposal; Electrical and electronic equipment, Packaging	V 1.0.0	pdf 265.8 kB	Download
--	---------	-----------------	----------

## CAD/CAE-Data

### CAE data

EPLAN Data Portal 280-944/281-589	URL	Download
WSCAD Universe 280-944/281-589	URL	Download
EPLAN Data Portal 280-944/281-589	URL	Download
WSCAD Universe 280-944/281-589	URL	Download

## Environmental Product Compliance

### Compliance Search

Environmental Product Compliance 280-944/281-589 Component terminal block; double-deck; with end plate; with 1.5KE33C TVS diode; 24 VDC; for DIN-rail 35 x 15 and 35 x 7.5; 2.5 mm <sup>2</sup> ; CAGE CLAMP®; 2,50 mm <sup>2</sup> ; gray	URL	Download
--	-----	----------

## Installation Notes

Subject to changes. Please also observe the further product documentation!

WAGO Kontakttechnik GmbH & Co. KG  
Hansastr. 27  
32423 Minden  
Phone: +49571 887-0 | Fax: +49571 887-169  
Email: [info.de@wago.com](mailto:info.de@wago.com) | Web: [www.wago.com](http://www.wago.com)

Do you have any questions about our products?  
We are always happy to take your call at +49 (571) 887-44222.