

2138530-1 ✓ ACTIVE

AMP | AMPSEAL

TE Internal #: 2138530-1

Backshell, PBT, 14 Position, AMPSEAL

[View on TE.com >](#)



Connectors > Connector Accessories > Connector Backshells > AMPSEAL Backshells



Connector Backshell Product Type: **Backshell**

Primary Product Material: **PBT**

Number of Positions: **14**

Sealable: **No**

Operating Temperature Range: **-40 – 105 °C [-40 – 221 °F]**

[All AMPSEAL Backshells \(5\)](#)

Features

Product Type Features

Connector Backshell Product Type	Backshell
Sealable	No

Configuration Features

Number of Positions	14
---------------------	----

Body Features

Cable Exit Angle	180°
Primary Product Color	Black
Primary Product Material	PBT

Usage Conditions

Operating Temperature (Max)	70 °C, 75 °C, 80 °C, 85 °C, 90 °C, 100 °C, 105 °C[158 °F][167 °F][176 °F][185 °F][194 °F] [212 °F][221 °F]
Operating Temperature Range	-40 – 105 °C[-40 – 221 °F]

Industry Standards



IP Rating	IP69
-----------	------

UL Flammability Rating	UL 94HB
------------------------	---------

Packaging Features

Packaging Quantity	1
--------------------	---

Packaging Method	Bag
------------------	-----

Other

Serviceable	Yes
-------------	-----

Product Compliance

[For compliance documentation, visit the product page on TE.com>](#)

EU RoHS Directive 2011/65/EU	Compliant
------------------------------	-----------

EU ELV Directive 2000/53/EC	Compliant
-----------------------------	-----------

China RoHS 2 Directive MIIT Order No 32, 2016	No Restricted Materials Above Threshold
---	---

EU REACH Regulation (EC) No. 1907/2006	Current ECHA Candidate List: JUNE 2023 (235) Candidate List Declared Against: JUNE 2023 (235) Does not contain REACH SVHC
--	---

Halogen Content	Low Halogen - Br, Cl, F, I < 900 ppm per homogenous material. Also BFR/CFR/PVC Free
-----------------	---

Solder Process Capability	Not applicable for solder process capability
---------------------------	--

Product Compliance Disclaimer

This information is provided based on reasonable inquiry of our suppliers and represents our current actual knowledge based on the information they provided. This information is subject to change. The part numbers that TE has identified as EU RoHS compliant have a maximum concentration of 0.1% by weight in homogenous materials for lead, hexavalent chromium, mercury, PBB, PBDE, DBP, BBP, DEHP, DIBP, and 0.01% for cadmium, or qualify for an exemption to these limits as defined in the Annexes of Directive 2011/65/EU (RoHS2). Finished electrical and electronic equipment products will be CE marked as required by Directive 2011/65/EU. Components may not be CE marked. Additionally, the part numbers that TE has identified as EU ELV compliant have a maximum concentration of 0.1% by weight in homogenous materials for lead, hexavalent chromium, and mercury, and 0.01% for cadmium, or qualify for an exemption to these limits as defined in the Annexes of Directive 2000/53/EC (ELV). Regarding the REACH Regulation, the information TE provides on SVHC in articles for this part number is based on the latest European Chemicals Agency (ECHA) 'Guidance on requirements for substances in articles' posted at this URL: <https://echa.europa.eu/guidance-documents/guidance-on-reach>

Compatible Parts



Also in the Series | AMPSEAL

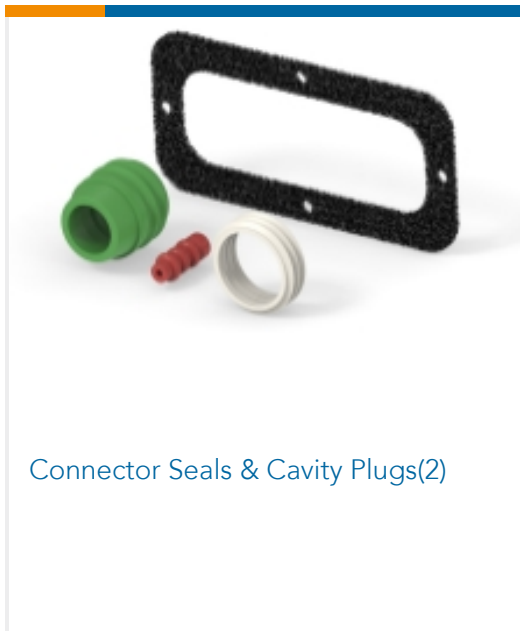
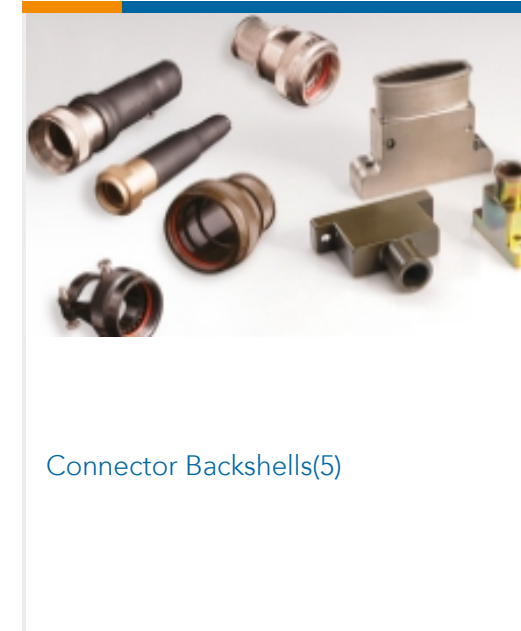
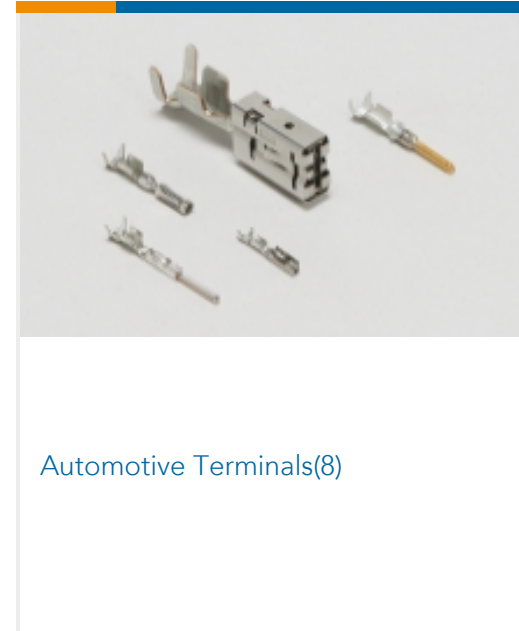
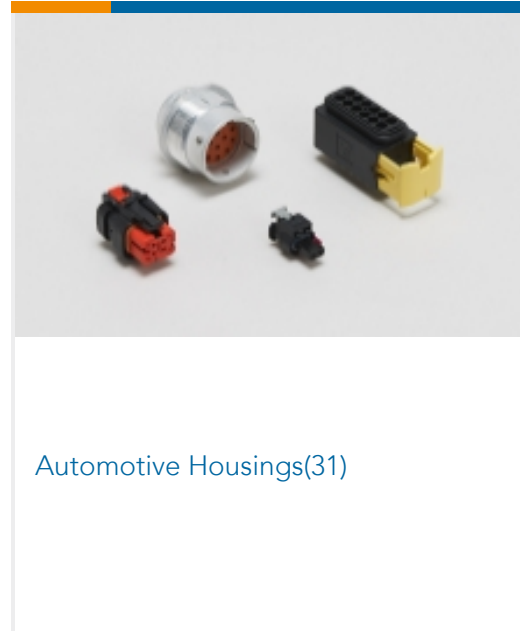
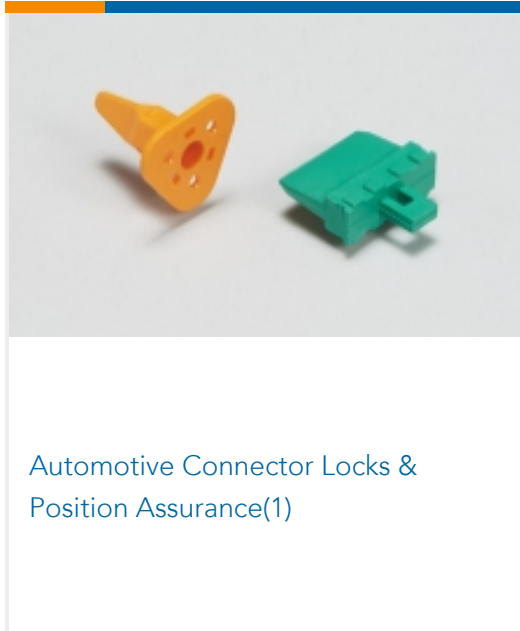

Customers Also Bought

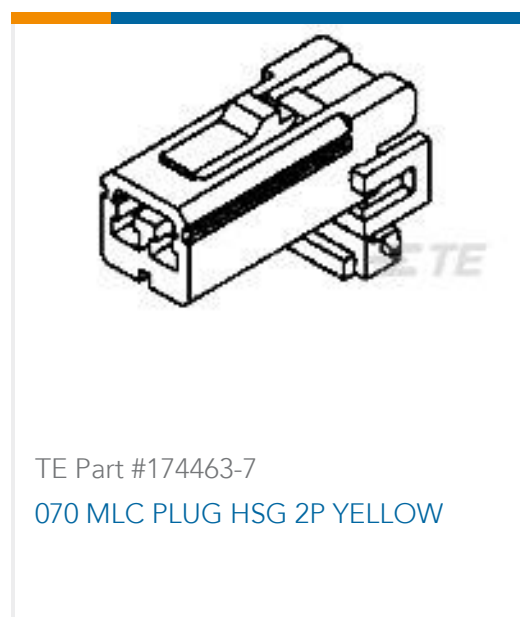
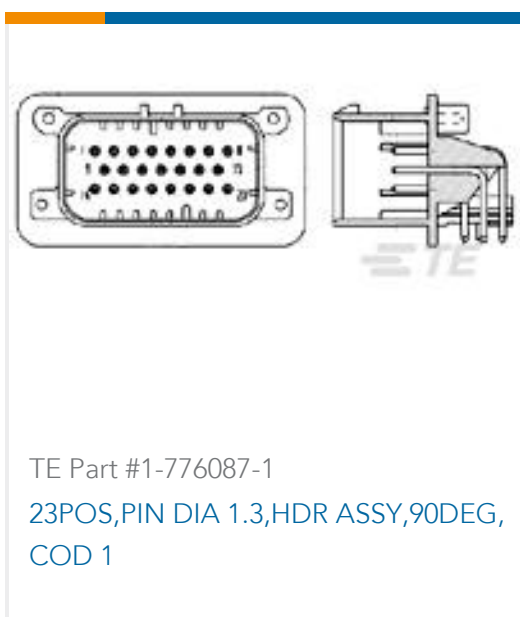
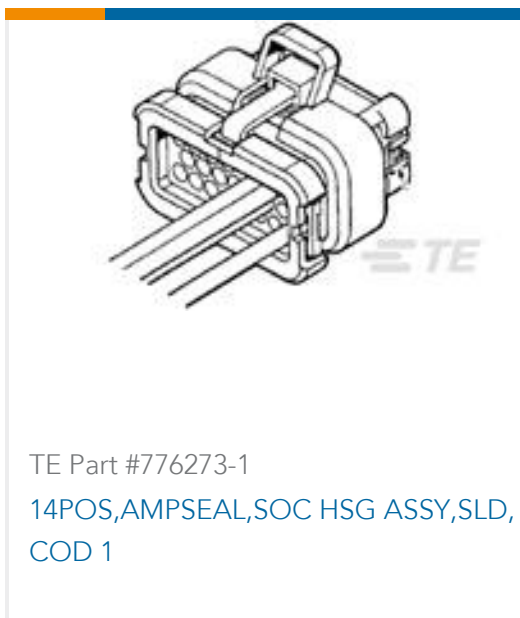



Documents

Product Drawings

[STRAIN RELIEF,14 POSITION AMPSEAL](#)

English

CAD Files

[3D PDF](#)

3D

Customer View Model

[ENG_CVM_CVM_2138530-1_D.2d_dxf.zip](#)

English

Customer View Model

[ENG_CVM_CVM_2138530-1_D.3d_igs.zip](#)

English

Customer View Model

[ENG_CVM_CVM_2138530-1_D.3d_stp.zip](#)

English

By downloading the CAD file I accept and agree to the [Terms and Conditions](#) of use.

Datasheets & Catalog Pages

[AMPSEAL Connector Catalog](#)

English

Product Specifications

[Application Specification](#)

English