

## Data sheet | Item number: 232-213/026-000

1-conductor female plug; angled; 2.5 mm<sup>2</sup>; Pin spacing 5 mm; 13-pole; 2,50 mm<sup>2</sup>; gray

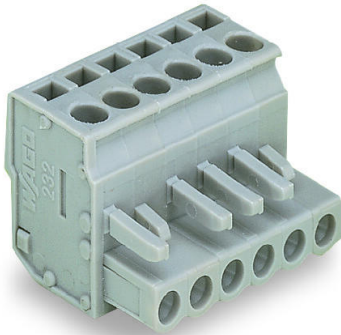

[www.wago.com/232-213/026-000](http://www.wago.com/232-213/026-000)



 Picture differs from the item.

RoHS  Compliant



Color: 

Derating Curve  
1-conductor female connector (231-102/026-000) with  
THT male header (231-432/001-000)  
Pin spacing: 5 mm / Conductor cross-section: 2.5 mm<sup>2</sup> \*F-st\*  
Based on: EN 60512-5-2 / Reduction factor: 0.8

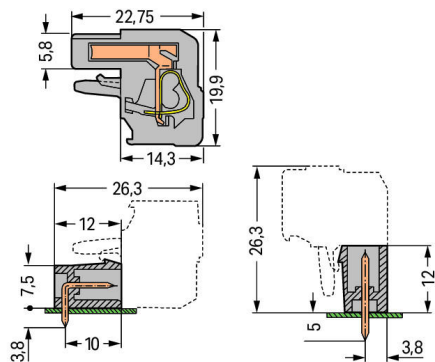
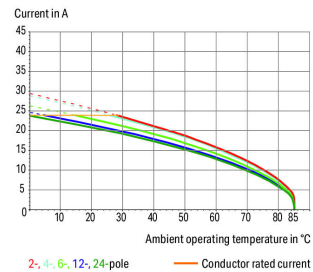

$$L = (\text{pole no.} \times \text{pin spacing}) + 1.5 \text{ mm} + 0.9 \text{ mm}$$

2- to 3-pole female connectors – one latch only

### Item description

- Universal connection for all conductor types

Subject to changes. Please also observe the further product documentation!

WAGO Kontakttechnik GmbH & Co. KG  
Hansastr. 27  
32423 Minden  
Phone: +49571 887-0 | Fax: +49571 887-169  
Email: [info.de@wago.com](mailto:info.de@wago.com) | Web: [www.wago.com](http://www.wago.com)

Do you have any questions about our products?  
We are always happy to take your call at +49 (571) 887-44222.



- Easy cable pre-assembly and on-unit wiring via vertical and horizontal CAGE CLAMP® actuation
- Integrated test ports
- With coding fingers

**Safety information 1:**

The MCS – MULTI CONNECTION SYSTEM includes connectors without breaking capacity in accordance with DIN EN 61984. When used as intended, these connectors must not be connected/disconnected when live or under load. The circuit design should ensure header pins, which can be touched, are not live when unmated.

**Data****Electrical data****Ratings per IEC/EN**

Ratings per	IEC/EN 60664-1
Nominal voltage (III/3)	320 V
Rated surge voltage (III/3)	4 kV
Rated voltage (III/2)	320 V
Rated surge voltage (III/2)	4 kV
Nominal voltage (II/2)	630 V
Rated surge voltage (II/2)	4 kV
Rated current	14 A
Legend (ratings)	(III / 2) ≙ Overvoltage category III / Pollution degree 2

**Ratings per UL**

Approvals per	UL 1059
Rated voltage UL (Use Group B)	300 V
Rated current UL (Use Group B)	15 A
Rated voltage UL (Use Group D)	300 V
Rated current UL (Use Group D)	10 A

**Ratings per UL**

Rated voltage UL 1977	600 V
Rated current UL 1977	15 A

**Ratings per CSA**

Approvals per	CSA
Rated voltage CSA (Use Group B)	300 V

Subject to changes. Please also observe the further product documentation!



Rated current CSA (Use Group B)	15 A
Rated voltage CSA (Use Group D)	300 V
Rated current CSA (Use Group D)	10 A

### Connection data

Connection technology	CAGE CLAMP®
Actuation type	Operating tool
Solid conductor	0.08 ... 2.5 mm <sup>2</sup> / 28 ... 12 AWG
Fine-stranded conductor	0.08 ... 2.5 mm <sup>2</sup> / 28 ... 12 AWG
Fine-stranded conductor; with insulated ferrule	0.25 ... 1.5 mm <sup>2</sup>
Fine-stranded conductor; with uninsulated ferrule	0.25 ... 2.5 mm <sup>2</sup>
Strip length	8 ... 9 mm / 0.31 ... 0.35 inch
Pole No.	13
Total number of connection points	13
Total number of potentials	13
Number of connection types	1
Number of levels	1
Conductor entry direction to mating direction	90°

### Physical data

Pin spacing	5 mm / 0.197 inch
Width	67.4 mm / 2.654 inch
Height	19.9 mm / 0.783 inch
Depth	22.75 mm / 0.896 inch

### Mechanical data

Design	angled
--------	--------

### Plug-in connection

Contact type (pluggable connector)	Female connector/socket
Connector (connection type)	for conductor
Mismating protection	No

### Material data

Color	gray
Material group	I

Subject to changes. Please also observe the further product documentation!

Insulation material	Polyamide (PA66)
Flammability class per UL94	V0
Clamping spring material	Chrome nickel spring steel (CrNi)
Contact material	Copper alloy
Contact plating	tin-plated
Fire load	0.397 MJ
Weight	24.3 g

### Environmental requirements



Limit temperature range	-60 ... +85 °C
-------------------------	----------------

### Commercial data

Product Group	3 (Multi Conn. System)
Packaging type	BOX
Country of origin	PL
GTIN	4044918388337
Customs tariff number	85366990990

### Approvals / Certificates

#### Country specific Approvals

Logo	Approval	Additional Approval Text	Certificate name
	<b>CB</b> DEKRA Certification B.V.	IEC 61984	NL-39756
	<b>CSA</b> DEKRA Certification B.V.	C22.2	1466354
	<b>KEMA/KEUR</b> DEKRA Certification B.V.	EN 61984	2190761.01

#### Ship Approvals

Logo	Approval	Additional Approval Text	Certificate name
	<b>ABS</b> American Bureau of Shipping	-	19- HG15869876- PDA

Subject to changes. Please also observe the further product documentation!



**BV**  
Bureau Veritas S.A.

IEC 60998

11915/D0 BV





**DNV GL**  
Det Norske Veritas, Germanischer Lloyd

-

TAE 000016Z

### UL-Approvals

Logo	Approval	Additional Approval Text	Certificate name
	<b>UL</b> Underwriters Laboratories Inc.	UL 1059	20190731-E45172
	<b>UL</b> Underwriters Laboratories Inc.	UL 1977	E45171

### Counterpart



**Item no.231-613**  
1-conductor male connector; 2.5 mm<sup>2</sup>; Pin spacing 5 mm; 13-pole; 2,50 mm<sup>2</sup>; gray

[www.wago.com/231-613](http://www.wago.com/231-613)



**Item no.231-143/001-000**  
THT male header; 1.0 x 1.0 mm solder pin; straight; Pin spacing 5 mm; 13-pole; gray

[www.wago.com/231-143/001-000](http://www.wago.com/231-143/001-000)



**Item no.231-443/001-000**  
THT male header; 1.0 x 1.0 mm solder pin; angled; Pin spacing 5 mm; 13-pole; gray

[www.wago.com/231-443/001-000](http://www.wago.com/231-443/001-000)

### Compatible products

#### tools



**Item no.: 209-130**  
Operating tool; suitable for 264, 280 and 281 Series; 1-way; of insulating material; white











[www.wago.com/209-130](http://www.wago.com/209-130)



**Item no.: 231-131**  
Push-button; loose

[www.wago.com/231-131](http://www.wago.com/231-131)

Subject to changes. Please also observe the further product documentation!

	<b>Item no.: 231-159</b> Operating tool; natural	<a href="http://www.wago.com/231-159">www.wago.com/231-159</a>
	<b>Item no.: 231-231</b> Combination operating tool; red	<a href="http://www.wago.com/231-231">www.wago.com/231-231</a>
	<b>Item no.: 231-291</b> Operating tool; loose; red	<a href="http://www.wago.com/231-291">www.wago.com/231-291</a>
	<b>Item no.: 280-432</b> Operating tool; made of insulating material; 2-way; white	<a href="http://www.wago.com/280-432">www.wago.com/280-432</a>
	<b>Item no.: 280-433</b> Operating tool; made of insulating material; 3-way	<a href="http://www.wago.com/280-433">www.wago.com/280-433</a>
	<b>Item no.: 280-434</b> Operating tool; made of insulating material; 4-way	<a href="http://www.wago.com/280-434">www.wago.com/280-434</a>
	<b>Item no.: 280-435</b> Operating tool; made of insulating material; 5-way; gray	<a href="http://www.wago.com/280-435">www.wago.com/280-435</a>
	<b>Item no.: 280-436</b> Operating tool; made of insulating material; 6-way	<a href="http://www.wago.com/280-436">www.wago.com/280-436</a>
	<b>Item no.: 280-437</b> Operating tool; made of insulating material; 7-way	<a href="http://www.wago.com/280-437">www.wago.com/280-437</a>
	<b>Item no.: 280-438</b> Operating tool; made of insulating material; 8-way	<a href="http://www.wago.com/280-438">www.wago.com/280-438</a>
	<b>Item no.: 280-440</b> Operating tool; made of insulating material; 10-way	<a href="http://www.wago.com/280-440">www.wago.com/280-440</a>

**General accessories**

	<b>Item no.: 231-668</b> Lockout caps; for covering unused clamping units; gray	<a href="http://www.wago.com/231-668">www.wago.com/231-668</a>
------------------------------------------------------------------------------------	------------------------------------------------------------------------------------	----------------------------------------------------------------

**Marking accessories**

<b>Item no.: 210-331/500-103</b> Marking strips; as a DIN A4 sheet; MARKED; 1-12 (300x); Height of marker strip: 2.3 mm/0.091 in; Strip length 182 mm; Horizontal marking; Self-adhesive; white	<a href="http://www.wago.com/210-331/500-103">www.wago.com/210-331/500-103</a>
<b>Item no.: 210-331/500-104</b> Marking strips; as a DIN A4 sheet; MARKED; 13-24 (300x); Height of marker strip: 2.3 mm/0.091 in; Strip length 182 mm; Horizontal marking; Self-adhesive; white	<a href="http://www.wago.com/210-331/500-104">www.wago.com/210-331/500-104</a>
<b>Item no.: 210-332/500-202</b> Marking strips; as a DIN A4 sheet; MARKED; 1-16 (160x); Height of marker strip: 3 mm; Strip length 182 mm; Horizontal marking; Self-adhesive; white	<a href="http://www.wago.com/210-332/500-202">www.wago.com/210-332/500-202</a>
<b>Item no.: 210-332/500-204</b> Marking strips; as a DIN A4 sheet; MARKED; 17-32 (160x); Height of marker strip: 3 mm; Strip length 182 mm; Horizontal marking; Self-adhesive; white	<a href="http://www.wago.com/210-332/500-204">www.wago.com/210-332/500-204</a>

Subject to changes. Please also observe the further product documentation!

**Item no.: 210-332/500-205**

Marking strips; as a DIN A4 sheet; MARKED; 1-32 (80x); Height of marker strip: 3 mm; Strip length 182 mm; Horizontal marking; Self-adhesive; white

[www.wago.com/210-332/500-205](http://www.wago.com/210-332/500-205)

**Item no.: 210-332/500-206**

Marking strips; as a DIN A4 sheet; MARKED; 33-48 (160x); Height of marker strip: 3 mm; Strip length 182 mm; Horizontal marking; Self-adhesive; white

[www.wago.com/210-332/500-206](http://www.wago.com/210-332/500-206)

**check**



**Item no.: 210-136**

Test plug; 2 mm Ø; with 500 mm cable; red

[www.wago.com/210-136](http://www.wago.com/210-136)



**Item no.: 210-137**

Test plug; 2.3 mm Ø; with 500 mm cable; yellow

[www.wago.com/210-137](http://www.wago.com/210-137)



**Item no.: 231-661**

Test plugs for female connectors; for 5 mm and 5.08 mm pin spacing; 2,50 mm<sup>2</sup>; light gray

[www.wago.com/231-661](http://www.wago.com/231-661)

**ferrule**



**Item no.: 216-101**

Ferrule; Sleeve for 0.5 mm<sup>2</sup> / AWG 22; uninsulated; electro-tin plated; silver-colored

[www.wago.com/216-101](http://www.wago.com/216-101)



**Item no.: 216-102**

Ferrule; Sleeve for 0.75 mm<sup>2</sup> / AWG 20; uninsulated; electro-tin plated; silver-colored

[www.wago.com/216-102](http://www.wago.com/216-102)



**Item no.: 216-103**

Ferrule; Sleeve for 1 mm<sup>2</sup> / AWG 18; uninsulated; electro-tin plated

[www.wago.com/216-103](http://www.wago.com/216-103)



**Item no.: 216-104**

Ferrule; Sleeve for 1.5 mm<sup>2</sup> / AWG 16; uninsulated; electro-tin plated; silver-colored

[www.wago.com/216-104](http://www.wago.com/216-104)



**Item no.: 216-106**

Ferrule; Sleeve for 2.5 mm<sup>2</sup> / AWG 14; uninsulated; electro-tin plated; silver-colored

[www.wago.com/216-106](http://www.wago.com/216-106)



**Item no.: 216-121**

Ferrule; Sleeve for 0.5 mm<sup>2</sup> / AWG 22; uninsulated; electro-tin plated; silver-colored

[www.wago.com/216-121](http://www.wago.com/216-121)



**Item no.: 216-122**

Ferrule; Sleeve for 0.75 mm<sup>2</sup> / AWG 20; uninsulated; electro-tin plated; silver-colored

[www.wago.com/216-122](http://www.wago.com/216-122)



**Item no.: 216-123**

Ferrule; Sleeve for 1 mm<sup>2</sup> / AWG 18; uninsulated; electro-tin plated; silver-colored

[www.wago.com/216-123](http://www.wago.com/216-123)



**Item no.: 216-124**

Ferrule; Sleeve for 1.5 mm<sup>2</sup> / AWG 16; uninsulated; electro-tin plated

[www.wago.com/216-124](http://www.wago.com/216-124)



**Item no.: 216-131**

Ferrule; Sleeve for 0.25 mm<sup>2</sup> / AWG 24; uninsulated; electro-tin plated; silver-colored

[www.wago.com/216-131](http://www.wago.com/216-131)



**Item no.: 216-132**

Ferrule; Sleeve for 0.34 mm<sup>2</sup> / AWG 24; uninsulated; electro-tin plated

[www.wago.com/216-132](http://www.wago.com/216-132)

**Item no.: 216-141**

Ferrule; Sleeve for 0.5 mm<sup>2</sup> / 20 AWG; uninsulated; electro-tin plated; electrolytic copper; gastight

[www.wago.com/216-141](http://www.wago.com/216-141)

Subject to changes. Please also observe the further product documentation!

WAGO Kontakttechnik GmbH & Co. KG

Hansastr. 27

32423 Minden

Phone: +49571 887-0 | Fax: +49571 887-169

Email: [info.de@wago.com](mailto:info.de@wago.com) | Web: [www.wago.com](http://www.wago.com)















Do you have any questions about our products?

We are always happy to take your call at +49 (571) 887-44222.

	crimped; acc. to DIN 46228, Part 1/08.92	
	<b>Item no.: 216-142</b> Ferrule; Sleeve for 0.75 mm <sup>2</sup> / 18 AWG; uninsulated; electro-tin plated; electrolytic copper; gastight crimped; acc. to DIN 46228, Part 1/08.92	<a href="http://www.wago.com/216-142">www.wago.com/216-142</a>
	<b>Item no.: 216-143</b> Ferrule; Sleeve for 1 mm <sup>2</sup> / AWG 18; uninsulated; electro-tin plated; electrolytic copper; gastight crimped; acc. to DIN 46228, Part 1/08.92	<a href="http://www.wago.com/216-143">www.wago.com/216-143</a>
	<b>Item no.: 216-144</b> Ferrule; Sleeve for 1.5 mm <sup>2</sup> / AWG 16; uninsulated; electro-tin plated; electrolytic copper; gastight crimped; acc. to DIN 46228, Part 1/08.92; silver-colored	<a href="http://www.wago.com/216-144">www.wago.com/216-144</a>
	<b>Item no.: 216-151</b> Ferrule; Sleeve for 0.25 mm <sup>2</sup> / AWG 24; uninsulated; electro-tin plated	<a href="http://www.wago.com/216-151">www.wago.com/216-151</a>
	<b>Item no.: 216-152</b> Ferrule; Sleeve for 0.34 mm <sup>2</sup> / AWG 24; uninsulated; electro-tin plated	<a href="http://www.wago.com/216-152">www.wago.com/216-152</a>
	<b>Item no.: 216-201</b> Ferrule; Sleeve for 0.5 mm <sup>2</sup> / 20 AWG; insulated; electro-tin plated; white	<a href="http://www.wago.com/216-201">www.wago.com/216-201</a>
	<b>Item no.: 216-202</b> Ferrule; Sleeve for 0.75 mm <sup>2</sup> / 18 AWG; insulated; electro-tin plated; gray	<a href="http://www.wago.com/216-202">www.wago.com/216-202</a>
	<b>Item no.: 216-203</b> Ferrule; Sleeve for 1 mm <sup>2</sup> / AWG 18; insulated; electro-tin plated; red	<a href="http://www.wago.com/216-203">www.wago.com/216-203</a>
	<b>Item no.: 216-204</b> Ferrule; Sleeve for 1.5 mm <sup>2</sup> / AWG 16; insulated; electro-tin plated; black	<a href="http://www.wago.com/216-204">www.wago.com/216-204</a>
	<b>Item no.: 216-221</b> Ferrule; Sleeve for 0.5 mm <sup>2</sup> / 20 AWG; insulated; electro-tin plated; white	<a href="http://www.wago.com/216-221">www.wago.com/216-221</a>
	<b>Item no.: 216-222</b> Ferrule; Sleeve for 0.75 mm <sup>2</sup> / 18 AWG; insulated; electro-tin plated; gray	<a href="http://www.wago.com/216-222">www.wago.com/216-222</a>
	<b>Item no.: 216-223</b> Ferrule; Sleeve for 1 mm <sup>2</sup> / AWG 18; insulated; electro-tin plated; red	<a href="http://www.wago.com/216-223">www.wago.com/216-223</a>
	<b>Item no.: 216-224</b> Ferrule; Sleeve for 1.5 mm <sup>2</sup> / AWG 16; insulated; electro-tin plated; black	<a href="http://www.wago.com/216-224">www.wago.com/216-224</a>
	<b>Item no.: 216-241</b> Ferrule; Sleeve for 0.5 mm <sup>2</sup> / 20 AWG; insulated; electro-tin plated; electrolytic copper; gastight crimped; acc. to DIN 46228, Part 4/09.90; white	<a href="http://www.wago.com/216-241">www.wago.com/216-241</a>
	<b>Item no.: 216-242</b> Ferrule; Sleeve for 0.75 mm <sup>2</sup> / 18 AWG; insulated; electro-tin plated; electrolytic copper; gastight crimped; acc. to DIN 46228, Part 4/09.90; gray	<a href="http://www.wago.com/216-242">www.wago.com/216-242</a>
	<b>Item no.: 216-243</b> Ferrule; Sleeve for 1 mm <sup>2</sup> / AWG 18; insulated; electro-tin plated; electrolytic copper; gastight crimped; acc. to DIN 46228, Part 4/09.90; red	<a href="http://www.wago.com/216-243">www.wago.com/216-243</a>
	<b>Item no.: 216-244</b>	

Subject to changes. Please also observe the further product documentation!



	Ferrule; Sleeve for 1.5 mm <sup>2</sup> / AWG 16; insulated; electro-tin plated; electrolytic copper; gastight crimped; acc. to DIN 46228, Part 4/09.90; black	<a href="http://www.wago.com/216-244">www.wago.com/216-244</a>
	<b>Item no.: 216-262</b> Ferrule; Sleeve for 0.75 mm <sup>2</sup> / 18 AWG; insulated; electro-tin plated; electrolytic copper; gastight crimped; acc. to DIN 46228, Part 4/09.90; gray	<a href="http://www.wago.com/216-262">www.wago.com/216-262</a>
	<b>Item no.: 216-263</b> Ferrule; Sleeve for 1 mm <sup>2</sup> / AWG 18; insulated; electro-tin plated; electrolytic copper; gastight crimped; acc. to DIN 46228, Part 4/09.90; red	<a href="http://www.wago.com/216-263">www.wago.com/216-263</a>
	<b>Item no.: 216-264</b> Ferrule; Sleeve for 1.5 mm <sup>2</sup> / AWG 16; insulated; electro-tin plated; electrolytic copper; gastight crimped; acc. to DIN 46228, Part 4/09.90; black	<a href="http://www.wago.com/216-264">www.wago.com/216-264</a>
	<b>Item no.: 216-284</b> Ferrule; Sleeve for 1.5 mm <sup>2</sup> / AWG 16; insulated; electro-tin plated; electrolytic copper; gastight crimped; acc. to DIN 46228, Part 4/09.90; black	<a href="http://www.wago.com/216-284">www.wago.com/216-284</a>
	<b>Item no.: 216-301</b> Ferrule; Sleeve for 0.25 mm <sup>2</sup> / AWG 24; insulated; electro-tin plated; yellow	<a href="http://www.wago.com/216-301">www.wago.com/216-301</a>
	<b>Item no.: 216-302</b> Ferrule; Sleeve for 0.34 mm <sup>2</sup> / 22 AWG; insulated; electro-tin plated; green	<a href="http://www.wago.com/216-302">www.wago.com/216-302</a>
	<b>Item no.: 216-321</b> Ferrule; Sleeve for 0.25 mm <sup>2</sup> / AWG 24; insulated; electro-tin plated; yellow	<a href="http://www.wago.com/216-321">www.wago.com/216-321</a>
	<b>Item no.: 216-322</b> Ferrule; Sleeve for 0.34 mm <sup>2</sup> / 22 AWG; insulated; electro-tin plated; green	<a href="http://www.wago.com/216-322">www.wago.com/216-322</a>
<b>Insulation stop</b>		
	<b>Item no.: 231-670</b> Insulation stop; 0.08-0.2 mm <sup>2</sup> / 0.2 mm <sup>2</sup> "s"; white	<a href="http://www.wago.com/231-670">www.wago.com/231-670</a>
	<b>Item no.: 231-671</b> Insulation stop; 0.25 - 0.5 mm <sup>2</sup> ; light gray	<a href="http://www.wago.com/231-671">www.wago.com/231-671</a>
	<b>Item no.: 231-672</b> Insulation stop; 0.75 - 1 mm <sup>2</sup> ; dark gray	<a href="http://www.wago.com/231-672">www.wago.com/231-672</a>
<b>Jumper</b>		
	<b>Item no.: 231-902</b> Jumper; for conductor entry; gray	<a href="http://www.wago.com/231-902">www.wago.com/231-902</a>
	<b>Item no.: 231-903</b> Jumper; for conductor entry; 3-way; insulated; gray	<a href="http://www.wago.com/231-903">www.wago.com/231-903</a>
	<b>Item no.: 231-905</b> Jumper; for conductor entry; 5-way; insulated; gray	<a href="http://www.wago.com/231-905">www.wago.com/231-905</a>
	<b>Item no.: 231-907</b> Jumper; for conductor entry; 7-way; insulated; gray	<a href="http://www.wago.com/231-907">www.wago.com/231-907</a>
	<b>Item no.: 231-910</b> Jumper; for conductor entry; 10-way; insulated; gray	<a href="http://www.wago.com/231-910">www.wago.com/231-910</a>

Subject to changes. Please also observe the further product documentation!



## Downloads

### Documentation

#### Additional Information

Technical explanations	3. 4. 2019	pdf 2.0 MB	Download
------------------------	------------	---------------	----------

## CAD/CAE-Data

### CAD data

2D/3D Models 232-213/026-000	URL	Download
------------------------------	-----	----------

### CAE data

EPLAN Data Portal 232-213/026-000	URL	Download
-----------------------------------	-----	----------

ZUKEN Portal 232-213/026-000	URL	Download
------------------------------	-----	----------

EPLAN Data Portal 232-213/026-000	URL	Download
-----------------------------------	-----	----------

## Environmental Product Compliance

### Compliance Search

Environmental Product Compliance 232-213/026-000 1-conductor female plug; angled; 2.5 mm <sup>2</sup> ; Pin spacing 5 mm; 13-pole; 2,50 mm <sup>2</sup> ; gray	URL	Download
-------------------------------------------------------------------------------------------------------------------------------------------------------------------	-----	----------

## Installation Notes

### Conductor termination

Subject to changes. Please also observe the further product documentation!

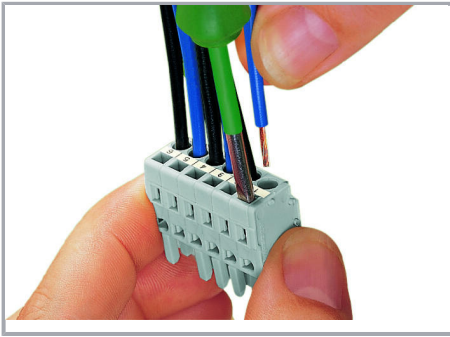

Inserting a conductor via 3.5 mm screwdriver – CAGE CLAMP® actuation parallel to conductor entry.

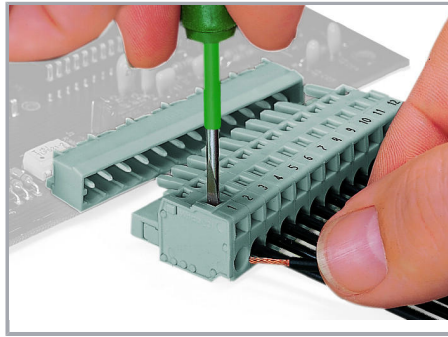

Inserting a conductor via 3.5 mm screwdriver – CAGE CLAMP® actuation perpendicular to conductor entry.

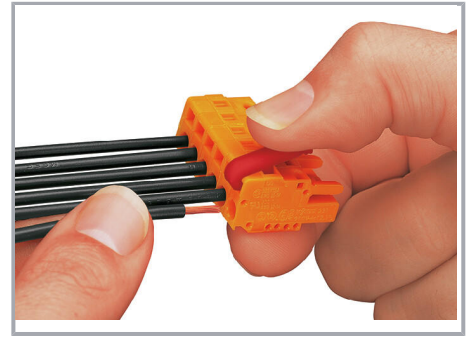

Inserting a conductor into CAGE CLAMP® unit via operating lever (231-291).

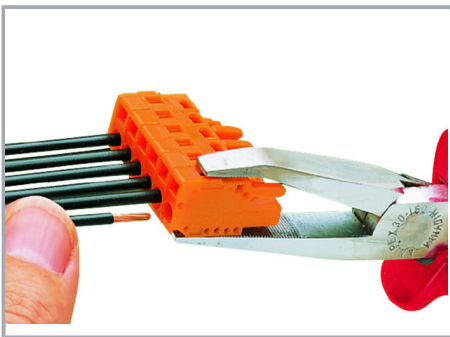

Inserting a conductor via operating tool.

### Coding



Coding a female connector by removing coding finger(s).

### Testing

Subject to changes. Please also observe the further product documentation!

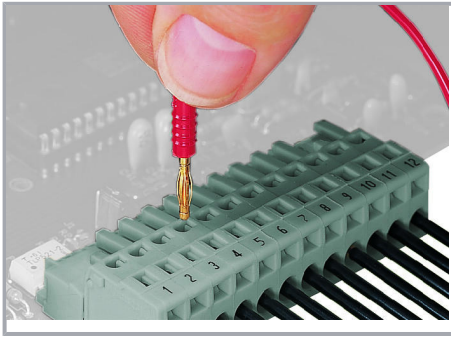

Testing – female connector with CAGE CLAMP®

Integrated test ports for testing perpendicular to conductor entry via 2 or 2.3 mm Ø test plug

### Installation

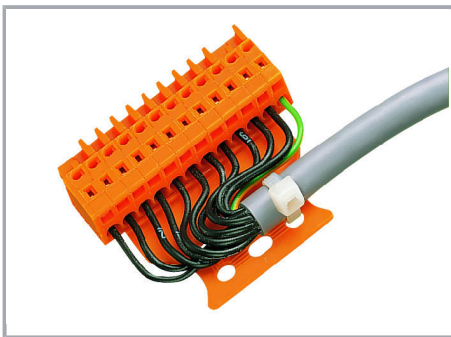

Male connector with strain relief plate

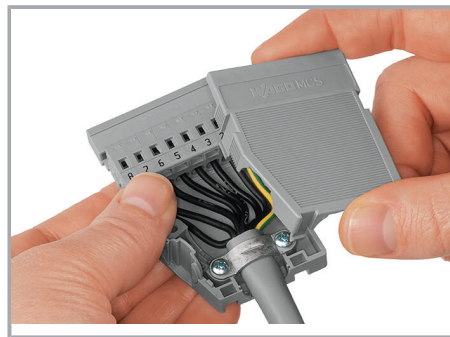

Strain relief housing shown with a male connector equipped with CAGE CLAMP®

### Marking

Subject to changes. Please also observe the further product documentation!

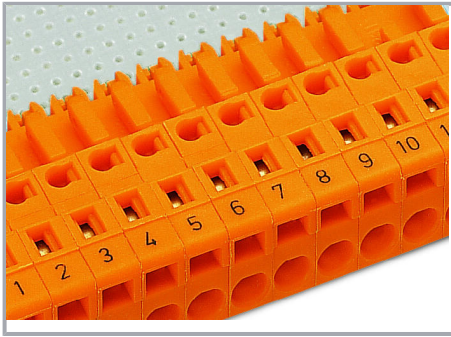

Labeling via direct marking or self-adhesive strips.

### Product family

*MCS* MIDI Classic

[Show all products from the family](#)

Subject to changes. Please also observe the further product documentation!