

91519-1 ✓ ACTIVE

AMP

TE Internal #: 91519-1

Premium Crimp Tooling, Not Releasable, Not Adjustable, Fixed In Tool, TE Product Specification (114-), Hand Crimping Tools

[View on TE.com >](#)



Application Tooling > Hand Crimping Tools



Tool Grade: **Premium Crimp Tooling**

Ratchet Configuration: **Not Releasable, Not Adjustable**

Die Sets Type: **Fixed In Tool**

Specification Type: **TE Product Specification (114-)**

TE Certification: **Yes – Certificate Included**

Features

Other

| | |
|-----------------------------|---|
| Crimp Form-Wire Barrel Type | Open Barrel - F Crimp |
| Tool Grade | Premium Crimp Tooling |
| Ratchet Configuration | Not Releasable, Not Adjustable |
| Die Sets Type | Fixed In Tool |
| Specification Type | TE Product Specification (114-) |
| TE Certification | Yes – Certificate Included |
| Power Technology Type | Battery, Electric, Manual |
| Tooling Type | CERTI-CRIMP II, Straight Action Hand Tool |

Product Compliance

[For compliance documentation, visit the product page on TE.com>](#)

| | |
|---|---|
| EU RoHS Directive 2011/65/EU | Out of Scope |
| EU ELV Directive 2000/53/EC | Out of Scope |
| China RoHS 2 Directive MIIT Order No 32, 2016 | 有害物质含量超出标准 Restricted Substance(s) Above Threshold |
| EU REACH Regulation (EC) No. 1907/2006 | Current ECHA Candidate List: JUNE 2025 (250) Candidate List Declared Against: JUNE 2025 (250) Does not contain REACH SVHC |















| | |
|---------------------------|--|
| Halogen Content | Low Halogen - Br, Cl, F < 900 ppm per homogenous material. Also BFR/CFR/PVC Free |
| Solder Process Capability | Not applicable for solder process capability |

Product Compliance Disclaimer

This information is provided based on reasonable inquiry of our suppliers and represents our current actual knowledge based on the information they provided. This information is subject to change. The part numbers that TE has identified as EU RoHS compliant have a maximum concentration of 0.1% by weight in homogenous materials for lead, hexavalent chromium, mercury, PBB, PBDE, DBP, BBP, DEHP, DIBP, and 0.01% for cadmium, or qualify for an exemption to these limits as defined in the Annexes of Directive 2011/65/EU (RoHS2). Finished electrical and electronic equipment products will be CE marked as required by Directive 2011/65/EU. Components may not be CE marked. Additionally, the part numbers that TE has identified as EU ELV compliant have a maximum concentration of 0.1% by weight in homogenous materials for lead, hexavalent chromium, and mercury, and 0.01% for cadmium, or qualify for an exemption to these limits as defined in the Annexes of Directive 2000/53/EC (ELV). Regarding the REACH Regulation, the information TE provides on SVHC in articles for this part number is based on the latest European Chemicals Agency (ECHA) 'Guidance on requirements for substances in articles' posted at this URL: <https://echa.europa.eu/guidance-documents/guidance-on-reach>

Compatible Parts

| | | | |
|--|--|--|--|
|  <p>TE Part # 213853-1 CPC PLUG ASSEMBLY SIZE 23-19</p> |  <p>TE Part # 1-66359-7 III+ PIN,18-14,TIN-LEAD,STRIP</p> |  <p>TE Part # 1-66361-6 III+PIN,18-14,TIN,LP,SN</p> |  <p>TE Part # 796188-1 SLD CPC PLUG ASSY,23-24,STD SX</p> |
|  <p>TE Part # 796274-1 SLD CPC PLUG ASSY,17-16,STD SX</p> |  <p>TE Part # 1-66359-9 III+PIN,18-14,TIN,STRIP</p> |  <p>TE Part # 1-66359-8 III+PIN,18-14,TIN,STRIP</p> |  <p>TE Part # 1-66361-5 III+ PIN,18-14,TIN-LEAD,LP</p> |
|  <p>TE Part # 1-66359-4 III+ PIN,18-14,TIN,STRIP</p> |  <p>TE Part # 1-66359-6 III+ PIN,18-14,30AU/FL,STRIP</p> |  <p>TE Part # 1-66360-2 III+ SKT,18-14,TIN ,LP</p> |  <p>TE Part # 1-66361-1 III+ PIN,18-14,30AU/FL,SMPACK</p> |



Customers Also Bought

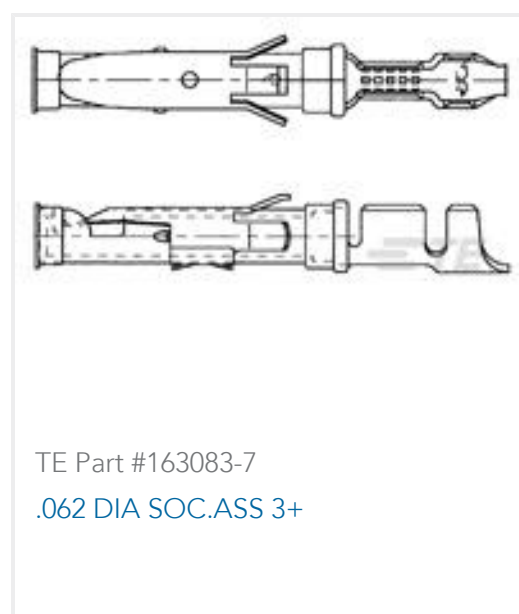

Documents



Datasheets & Catalog Pages

[AMP Circular Connectors for Commercial Signal & Power Applications](#)

English

[Signal Contacts](#)

English

[Bottoming Dies](#)

English

[CERTI-CRIMP II TOOL DATA SHEET MULTIMATE CONTACT FAMILY OPEN BARREL](#)

English

Instruction Sheets

[Instruction Sheet \(U.S.\)](#)

English