

MVSP27x-15,24-V euroclamp

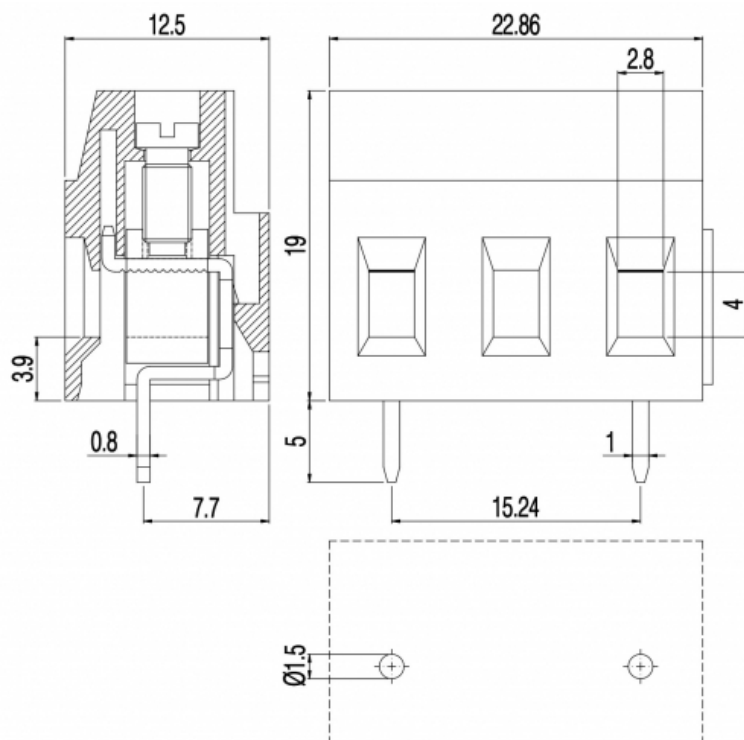
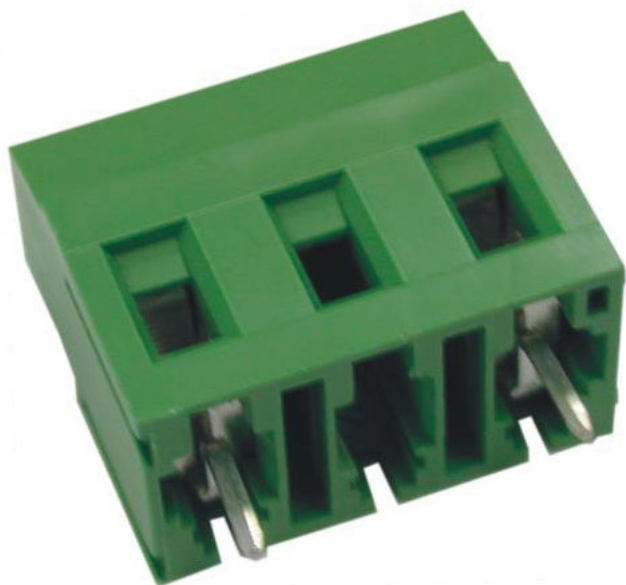

Single-deck terminal block - Modular version - Pitch 15,24mm - 1÷2 poles

GENERAL INFORMATION

pitch:	15,24 mm
housing height:	19,00 mm
housing depth:	12.5 mm
dimensional class:	medium
wire section:	2.5 mm ² / 14 AWG
clamp opening size:	2.8 × 4 mm
wire stripping:	max 9.5 mm
operating temperature:	-40°C ÷ +130°C

ELECTRICAL CHARACTERISTICS

current:	24A
voltage:	750V
test voltage:	3 kVrms/60s

MECHANICAL CHARACTERISTICS

screw:	M3
max. torque:	0.8 Nm / 7.2 in.lbs

APPROVALS DATA



EN 60998-1

current:	24A
voltage:	750V
wire section:	2.5mm ²
torque:	0.8Nm
FILE:	CA02.00599



-

-

-

-

-

-



UL 1059

20A factory / 15A field

600V







14÷30AWG

4.5Lb-in

E178356

MATERIALS

AVAILABLE COLOURS

housing: PA - UL 94 V0  (STD)      
 screw: Galvanized steel
 clamp/spring: Nickeled copper alloy other colours: upon request
 terminal: Tin-plated copper alloy

poles	P/N	pcs/pack	W [Kg]*	W [Kg]*
1	MVSP271-15,24-V	N/A	N/A	N/A
2	MVSP272-15,24-V	N/A	N/A	N/A
..	MVSP27..-15,24-V	N/A	N/A	N/A