

9000 series

Proportional fingertip controllers •
inductive sensing technology



DISTINCTIVE FEATURES

Proportional analog output

One or two axis

Infinite resolution

Low profile design with multiple handle options



ENVIRONMENTAL SPECIFICATIONS

- Operating Temperature: -20 °C to +55 °C (-4 °F to +131 °F)
- Storage Temperature: -20 °C to +55 °C (-4 °F to +131 °F)
- Sealing: IP65 Above panel (subject to final specifications)
- EMC Immunity Level: EN61000-4-3
- EMC Emissions Level: EN61000-6-3: 2001
- ESD: EN61000-4-2



ELECTRICAL SPECIFICATIONS

- Supply Voltage: 4.75V min to 15 V max
- Output Signal Tolerance: $\pm 10\%$ of Output
- Supply Current: Typically 10 mA
- Output Impedance: 1.8 Ω
- Signal Swing: $\pm 10\%$ of VCC to $\pm 50\%$ of VCC
- Output at Center: $\pm 1\%$



MECHANICAL SPECIFICATIONS

- Mechanical Angle of Movement: 18°
- Mechanical Life: 10 million lifecycles
- Mass/weight: 90 g (0.20 lbs)



MATERIALS

- Body: Glass Reinforced ABS
- Boot: Neoprene
- Shaft: Stainless Steel
- Other: Brass, Acetal, Nylon

The company reserves the right to change specifications without notice.



9000 series

Proportional fingertip controllers •
inductive sensing technology



MOUNTING

DROP IN - PANEL CUT OUT AND INSTALLATION

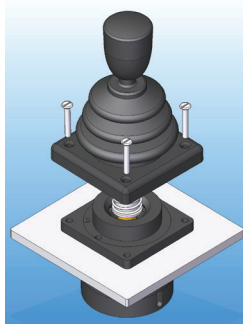
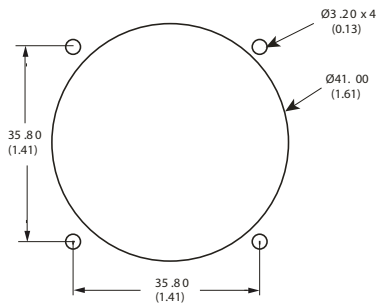

- The joystick is dropped into the panel cut-out. The joystick and boot must be kept in place by bezel (option 6 & 7).

- For panel thickness of <3 mm, m3 x 16 countersunk machine screws are recommended.

- To ensure a good panel seal, gaskets are available as an optional extra.

OPTION A - PANEL CUT OUT AND INSTALLATION

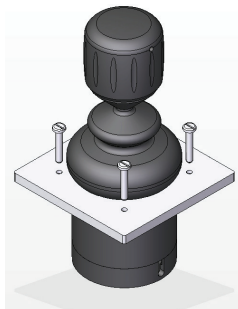
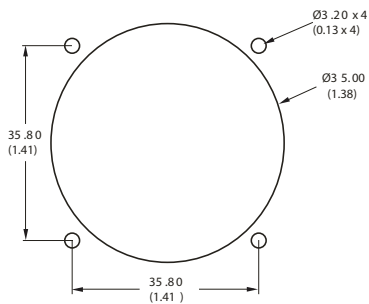

- When mounted this way the panel acts as the bezel and no separate bezel is needed.

- M3 machine screws are recommended.

OPTION B - PANEL CUT OUT AND INSTALLATION

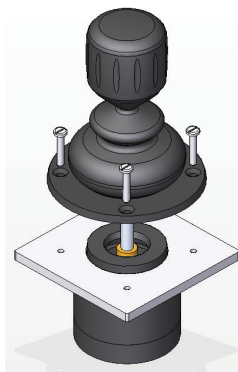
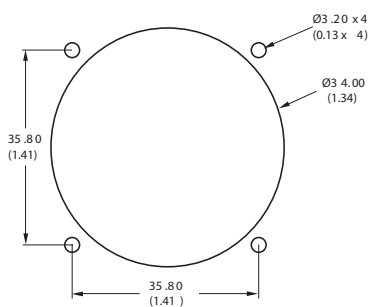

- The joystick flange is mounted beneath the panel and the base of the boot must be brought through the panel cut-out and held in place with the circular bezel (option 4).

- For panel thicknesses of up to 3 mm, m3 x 16 countersunk machine screws are recommended.



NEAR EQUIVALENT CIRCUIT

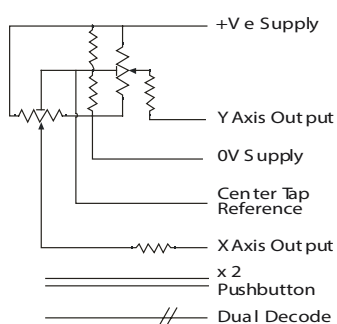

9000 series

Proportional fingertip controllers • inductive sensing technology



BUILD YOUR PART NUMBER

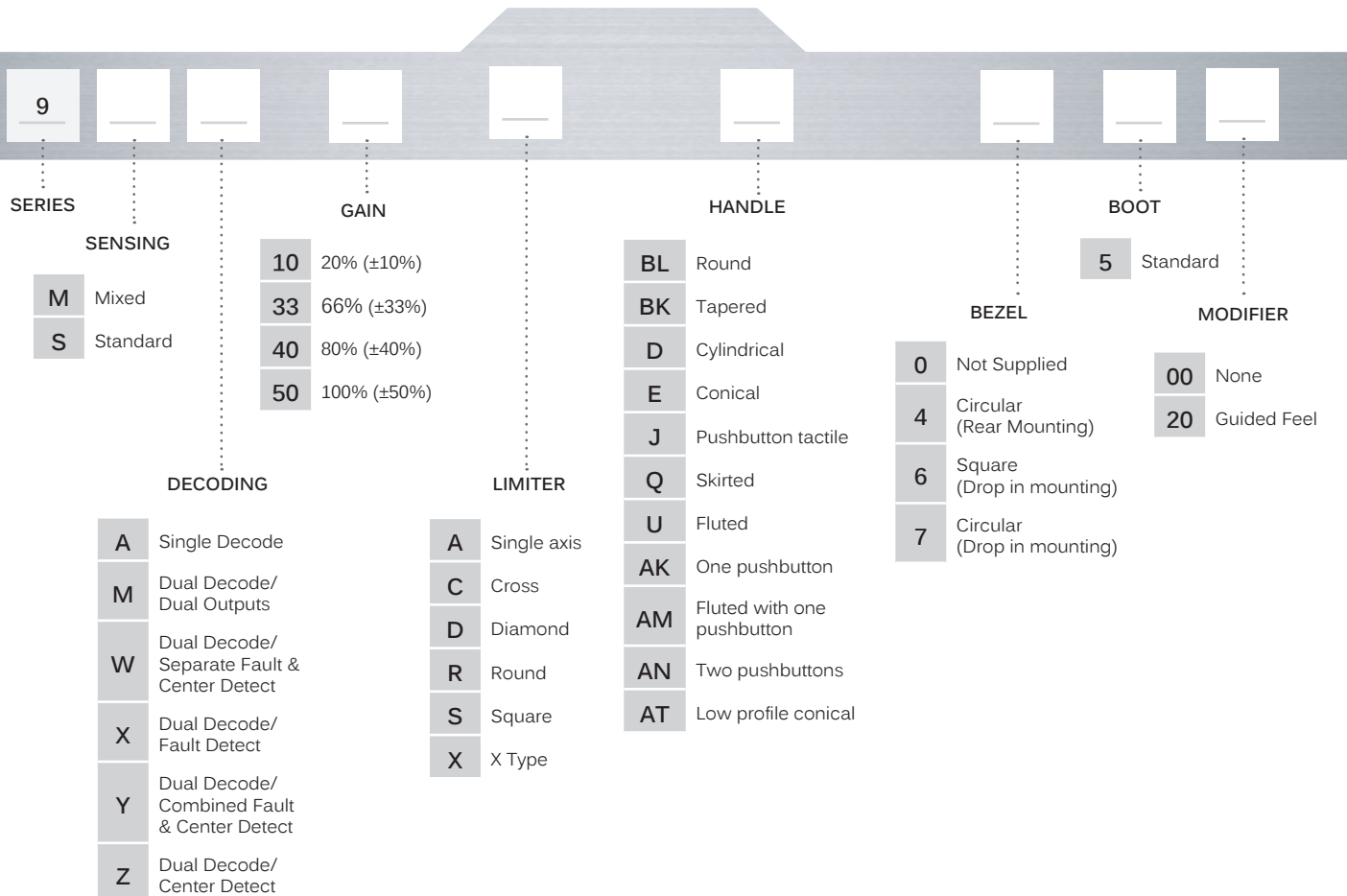

ABOUT THIS SERIES

NOTES:

1. Bezel options: For drop in mounting, please specify bezel option 6 or 7. No bezel is necessary for sub-panel mounting unless the boot is required to seal to the front face of the panel - bezel option 4. Bezels 6 & 7 clamp the boot and top face of the joystick body to the panel, whereas bezel 4 clamps only the boot. Some handles may be larger than some panel cut outs. This may restrict the choice of mounting and bezel options. Please contact APEM for assistance.
2. Springs: The 9000 series is spring return to center. The standard force requires 1.3N (nominally) to off-center the joystick. Note: forces quoted are subject to exact joystick configuration and are provided as a guide only.
3. Dual Decode Interface: For optimum performance of the center detect signals, APEM recommends the signals are pulled high via the input resistor of typically 22k, on the controller circuitry.
4. Center Tap reference: All 9000 series output a center tap reference as standard. This reference is set within the joystick at 50% of VCC (±1%). For optimum accuracy, the outputs should be read relative to the center tap.
5. Non-standard: Further non-standard options including custom handles or special limiter plates are available. Please contact APEM for further details.

9000 series

Proportional fingertip controllers • inductive sensing technology

DIMENSIONS

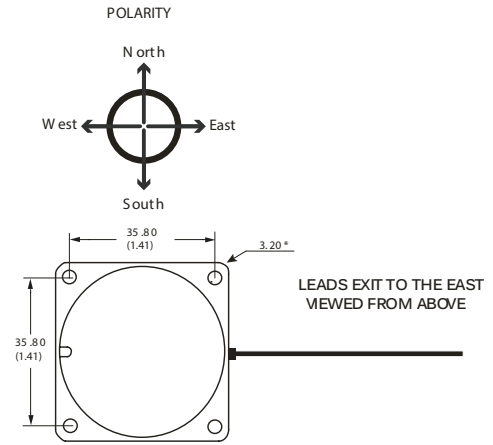
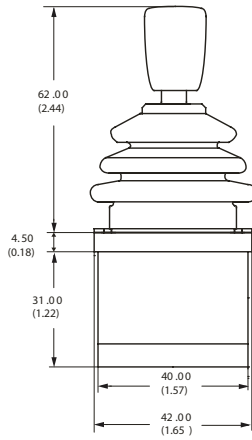

HANDLE OPTIONS

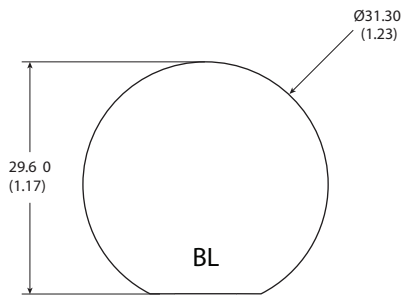

MATERIAL Nylon
 FINISH Non Textured
 STANDARD COLOR Black
 OTHER COLORS Not Available
 NOTES:

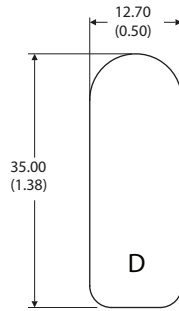

Aluminum
 Anodized
 Black
 Not Available

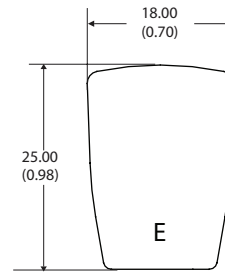

Nylon
 Sparked Matt
 Black
 Upon Request

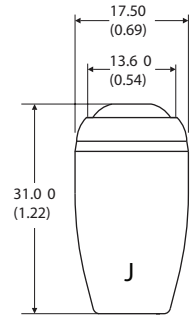

ABS
 Sparked Matt
 Black
 Upon Request
 Uses APEM IS Switches

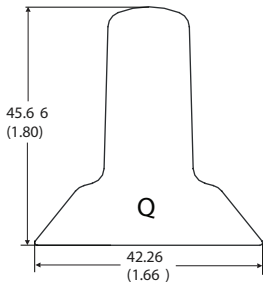

MATERIAL Nylon
 FINISH Sparked Matt
 STANDARD COLOR Black
 OTHER COLORS Upon Request
 NOTES:

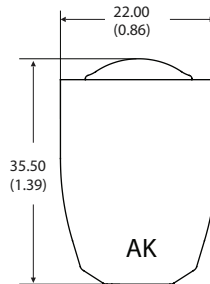

Aluminum
 Anodized
 Black
 Not Available
 Uses APEM IA Switches

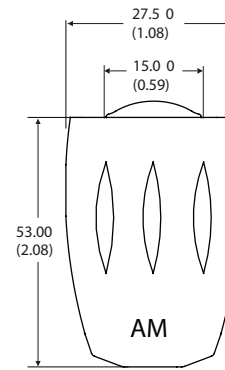

Aluminum
 Anodized
 Black
 Upon Request
 Uses APEM IA Switches

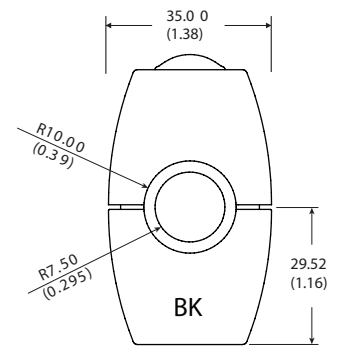

ABS
 Sparked Matt
 Black
 Upon Request
 Uses APEM IA Switches

Proportional fingertip controllers • inductive sensing technology



HANDLE OPTIONS (CONTINUED)

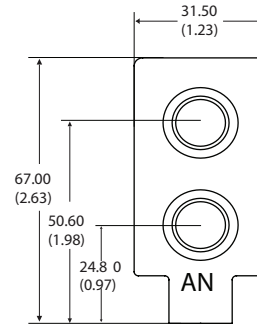
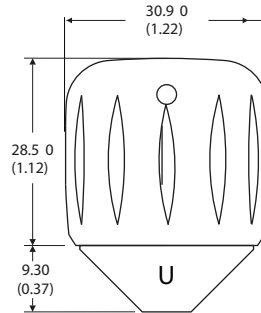
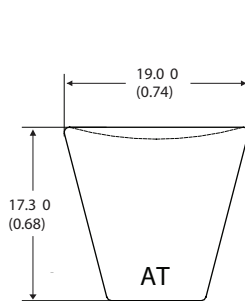

MATERIAL Nylon
 FINISH Sparked Matt
 STANDARD COLOR Black
 OTHER COLORS Upon Request
 NOTES:

Aluminum
 Anodized
 Black
 Not Available

Delrin
 Gloss
 Black
 Not Available
 Uses APEM IS Switches

NOTES:

1. Dimensions are in mm/(inch).
2. Unless otherwise specified, all joysticks are supplied with black switches in the handles.



CONFIGURATION OPTION

CIRCUITRY

The 9000 series joystick operates by passing an oscillating current through a drive coil, directly mounted at the lower end of the operating lever, and immediately above the four sensing coils. When the shaft and drive coil moves away from the center, the signals detected in each opposing pair of coils increase nominally in proportion to deflection.

The phase of those signals determine the direction. Synchronous electronic switches followed by integrating amplifiers provide DC signals directly equivalent to those of potentiometer joysticks, but with fixed output impedance and free of wiper noise and track wear.

DUAL DECODE

Designed for use in the most safety-critical applications, the 9000 series incorporates comprehensive internal monitoring circuitry whereby output signals are continually compared with separately generated 'mirror signals'. In the unlikely event of an internal fault, the dual decode system will generate a separate fault signal, enabling the controller to fail-to-safe. The dual decode system is a complete internal self-monitoring system, providing a far higher standard of protection.

An additional, 'away from center' signal is also available whenever required. Although the monitoring of the joystick is fully internal, the inverse 'mirror signals' can be available as external outputs where the monitor function is incorporated within the controller circuitry.

GUIDED FEEL

The 9000 series may also be specified with guided feel. A joystick with guided feel moves more readily towards the poles (N, S, E and W) and while it can still move away from the poles, the force required to do so is greater. Unless specified otherwise, joysticks are supplied as standard without guiding. This standard configuration allows the user to move the joystick anywhere within the limiter with the same force and without any bias.

FUNCTIONAL OPTIONS

The 9000 series can be configured in three different modes:

- Orthogonal, standard signals - Replicating that of a potentiometer.
- Deliberate signal mixing - Ideal for those applications whereby the method of steering is by controlling two motors. For example one motor uses X+Y signals and the other uses X-Y signals. This mixing is achieved by internally orientating the signals at 45° to normal. Typical applications may be twin propeller boats, tracked vehicles, or wheelchairs.
- Deliberate signal interaction - Enables reduction in one signal as the other increases. This option is particularly beneficial where it is undesirable to maintain full forward speed while turning and vice versa.