

PESD5V0L6UAS; PESD5V0L6US

Low capacitance 6-fold ESD protection diode arrays

Rev. 03 — 18 August 2009

Product data sheet

1. Product profile

1.1 General description

Low capacitance 6-fold ESD protection diode arrays in small plastic packages designed to protect up to six transmission or data lines from the damage caused by ElectroStatic Discharge (ESD) and other transients.

Table 1. Product overview

Type number	Package	
	Name	NXP
PESD5V0L6UAS	TSSOP8	SOT505-1
PESD5V0L6US	SO8	SOT96-1

1.2 Features

- ESD protection of up to six lines
- Low diode capacitance
- Max. peak pulse power: $P_{PP} = 35 \text{ W}$
- Low clamping voltage: $V_{(CL)R} = 15 \text{ V}$
- Ultra low leakage current: $I_{RM} = 8 \text{ nA}$
- ESD protection of up to 20 kV
- IEC 61000-4-2, level 4 (ESD)
- IEC 61000-4-5 (surge); $I_{PP} = 2.5 \text{ A}$

1.3 Applications

- Computers and peripherals
- Communication systems
- Audio and video equipment
- High speed data lines
- Parallel ports

1.4 Quick reference data

Table 2. Quick reference data

Symbol	Parameter	Conditions	Min	Typ	Max	Unit
V_{RWM}	reverse stand-off voltage		-	-	5	V
C_d	diode capacitance	$V_R = 0 \text{ V};$ $f = 1 \text{ MHz}$	-	16	19	pF

2. Pinning information

Table 3. Discrete pinning

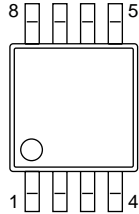
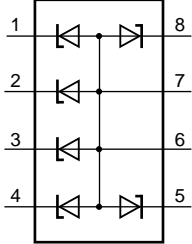
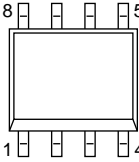
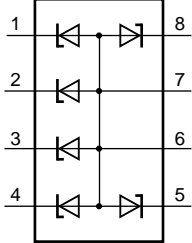
Pin	Description	Simplified outline	Symbol
TSSOP8			
1	cathode 1		 <p style="text-align: right;"><i>sym004</i></p>
2	cathode 2		
3	cathode 3		
4	cathode 4		
5	cathode 5		
6	common anode		
7	common anode		
8	cathode 6		
SO8			
1	cathode 1		 <p style="text-align: right;"><i>sym004</i></p>
2	cathode 2		
3	cathode 3		
4	cathode 4		
5	cathode 5		
6	common anode		
7	common anode		
8	cathode 6		

3. Ordering information

Table 4. Ordering information

Type number	Package		Version
	Name	Description	
PESD5V0L6UAS	TSSOP8	plastic thin shrink small outline package; 8 leads; body width 3 mm	SOT505-1
PESD5V0L6US	SO8	plastic small outline package; 8 leads; body width 3.9 mm	SOT96-1

4. Marking

Table 5. Marking

Type number	Marking code
PESD5V0L6UAS	5V06U
PESD5V0L6US	5V06US

5. Limiting values

Table 6. Limiting values

In accordance with the Absolute Maximum Rating System (IEC 60134).

Symbol	Parameter	Conditions	Min	Max	Unit
Per diode					
P _{PP}	peak pulse power	8/20 μs pulse	[1][2] -	35	W
I _{PP}	peak pulse current	8/20 μs pulse	[1][2] -	2.5	A
T _j	junction temperature		-	150	°C
T _{amb}	ambient temperature		-65	+150	°C
T _{stg}	storage temperature		-65	+150	°C

[1] Non-repetitive current pulse 8/20 μs exponentially decay waveform according to IEC 61000-4-5; see [Figure 1](#).

[2] Measured from pin 1, 2, 3, 4, 5 or 8 to pin 6 or 7.

Table 7. ESD maximum ratings

Symbol	Parameter	Conditions	Min	Max	Unit
ESD	electrostatic discharge capability	IEC 61000-4-2 (contact discharge)	[1][2] -	20	kV
		HBM MIL-STD883	-	10	kV

[1] Device stressed with ten non-repetitive ElectroStatic Discharge (ESD) pulses; see [Figure 2](#).

[2] Measured from pin 1, 2, 3, 4, 5 or 8 to pin 6 or 7.

Table 8. ESD standards compliance

Standard	Conditions
IEC 61000-4-2, level 4 (ESD); see Figure 2	> 15 kV (air); > 8 kV (contact)
HBM MIL-STD883, class 3	> 4 kV

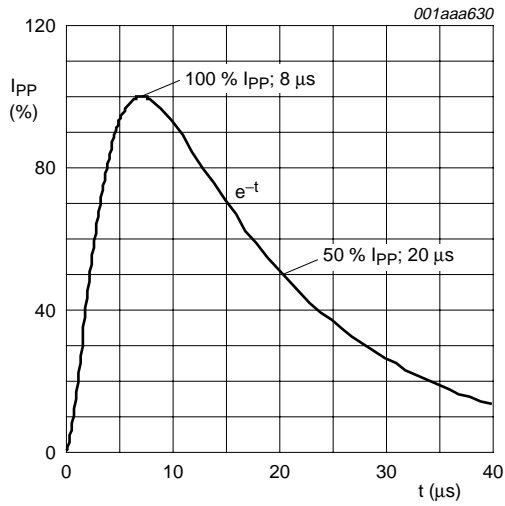

Fig 1. 8/20 μs pulse waveform according to IEC 61000-4-5

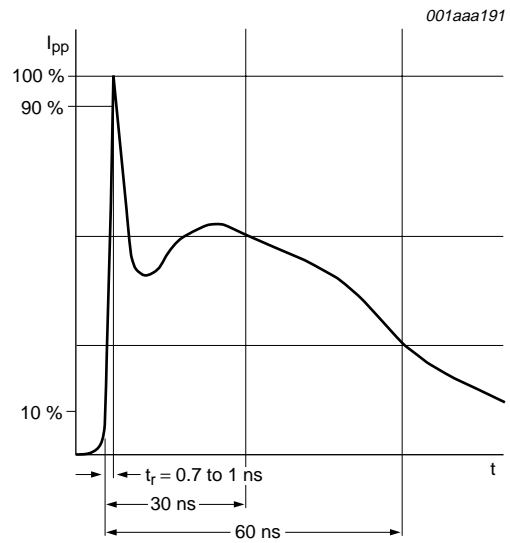

Fig 2. ElectroStatic Discharge (ESD) pulse waveform according to IEC 61000-4-2

6. Characteristics

Table 9. Characteristics

$T_{amb} = 25\text{ }^{\circ}\text{C}$ unless otherwise specified

Symbol	Parameter	Conditions	Min	Typ	Max	Unit
Per diode						
V_{RWM}	reverse stand-off voltage		-	-	5	V
I_{RM}	reverse leakage current	$V_{RWM} = 5\text{ V}$	-	8	25	nA
$V_{(CL)R}$	clamping voltage	$I_{PP} = 1\text{ A}$	[1][2] -	-	10	V
		$I_{PP} = 2.5\text{ A}$	[1][2] -	-	15	V
$V_{(BR)}$	breakdown voltage	$I_R = 1\text{ mA}$	6.4	6.8	7.2	V
r_{dif}	differential resistance	$I_R = 1\text{ mA}$	-	-	100	Ω
C_d	diode capacitance	$V_R = 0\text{ V}$; $f = 1\text{ MHz}$; see Figure 5	-	16	19	pF

[1] Non-repetitive current pulse 8/20 μs exponentially decay waveform according to IEC 61000-4-5; see [Figure 1](#).

[2] Measured between each cathode on pins 1, 2, 3, 4, 5 or 8 and anode on pin 6 or 7.

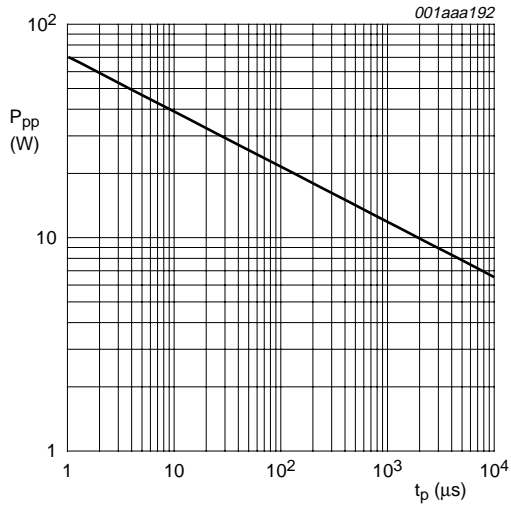

$T_{amb} = 25\text{ }^\circ C$

Fig 3. Peak pulse power as a function of exponential pulse duration t_p ; typical values

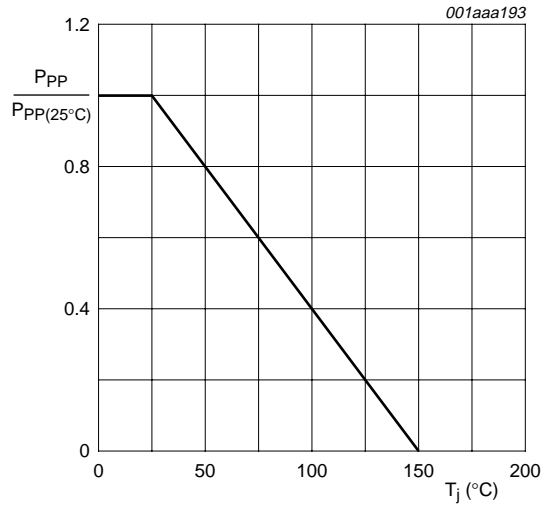
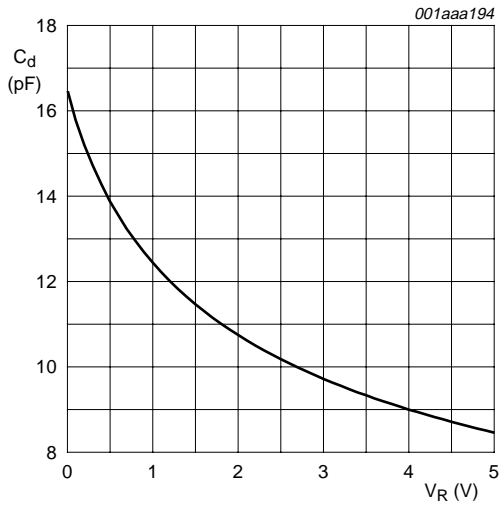

Fig 4. Relative variation of peak pulse power as a function of junction temperature; typical values



$T_{amb} = 25\text{ }^\circ C$; $f = 1\text{ MHz}$

Fig 5. Diode capacitance as a function of reverse voltage; typical values

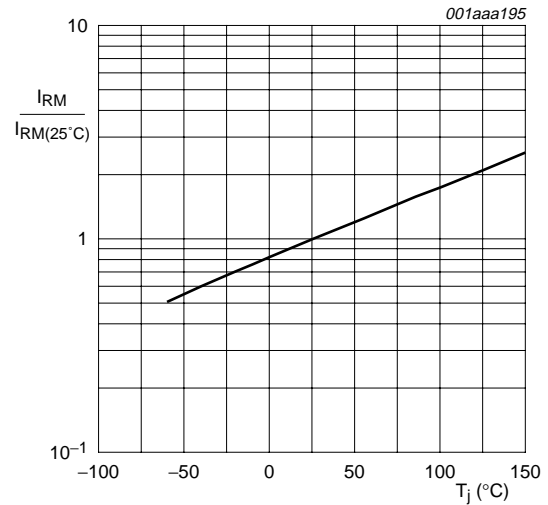

Fig 6. Relative variation of reverse leakage current as a function of junction temperature; typical values

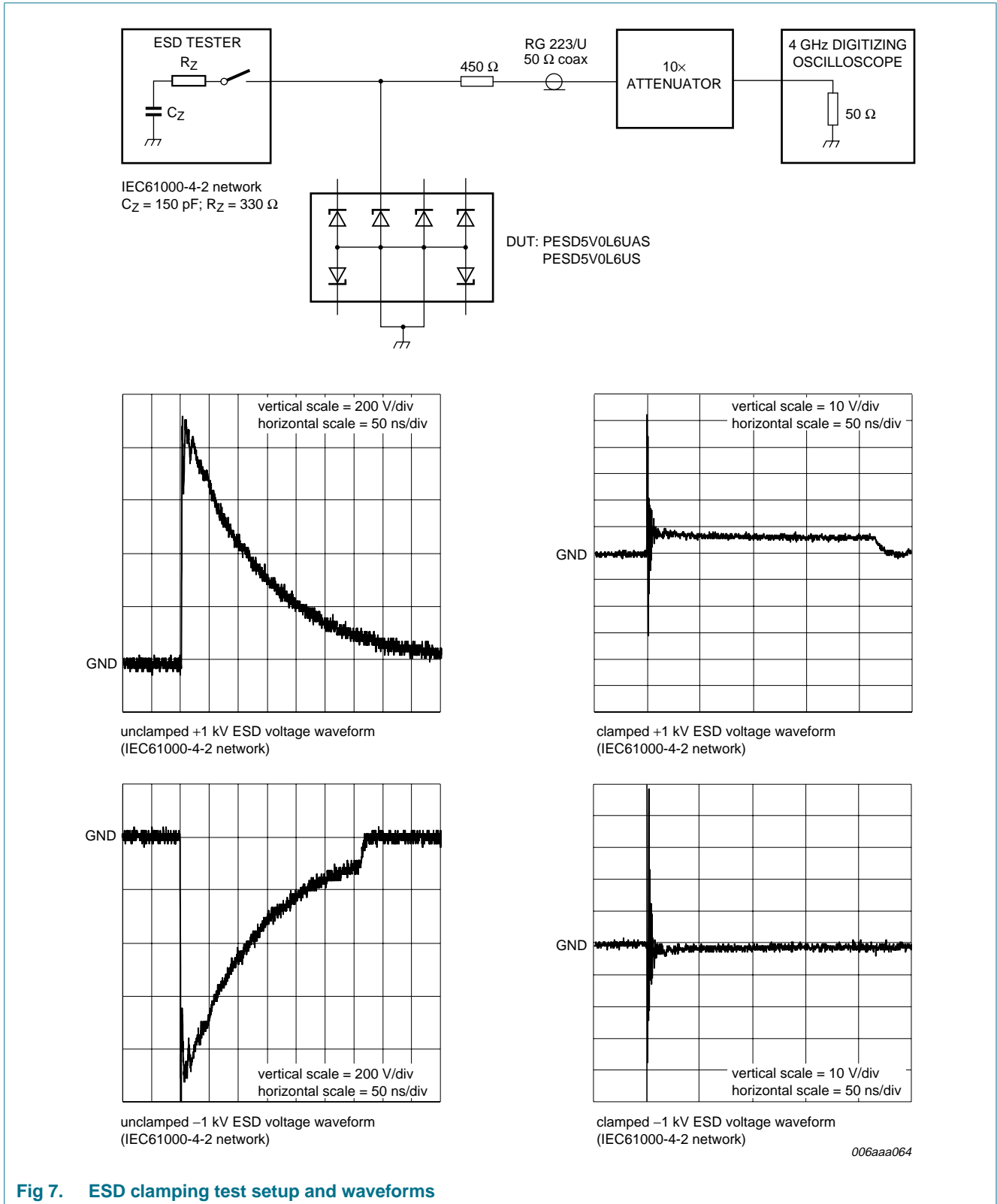

Fig 7. ESD clamping test setup and waveforms

7. Application information

The PESD5V0L6UAS and the PESD5V0L6US are designed for protection of up to six unidirectional data lines from the damage caused by ElectroStatic Discharge (ESD) and surge pulses. The PESD5V0L6UAS and the PESD5V0L6US may be used on lines where the signal polarity is above or below ground.

The PESD5V0L6UAS and the PESD5V0L6US provide a surge capability of 35 W per line for a 8/20 μ s waveform.

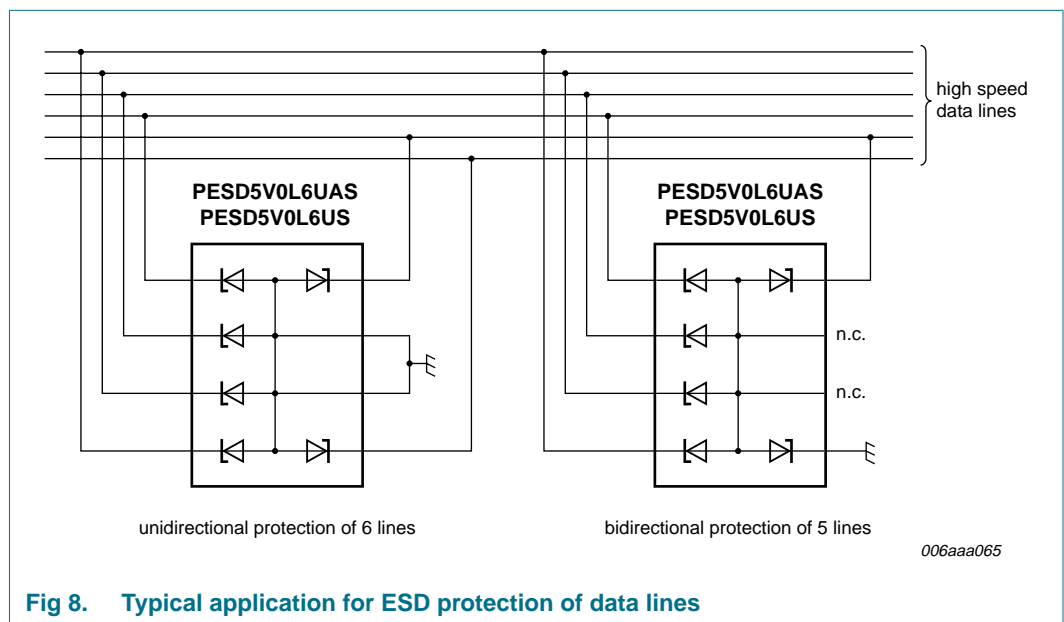

Fig 8. Typical application for ESD protection of data lines

Circuit board layout and protection device placement:

Circuit board layout is critical for the suppression of ESD, EFT and surge transients. The following guidelines are recommended:

1. Place the protection device as close to the input terminal or connector as possible.
2. The path length between the protection device and the protected line should be minimized.
3. Keep parallel signal paths to a minimum.
4. Avoid running protection conductors in parallel with unprotected conductor.
5. Minimize all printed-circuit board conductive loops including power and ground loops.
6. Minimize the length of the transient return path to ground.
7. Avoid using shared transient return paths to a common ground point.
8. Ground planes should be used whenever possible. For multilayer printed-circuit boards, use ground vias.

8. Package outline

TSSOP8: plastic thin shrink small outline package; 8 leads; body width 3 mm

SOT505-1

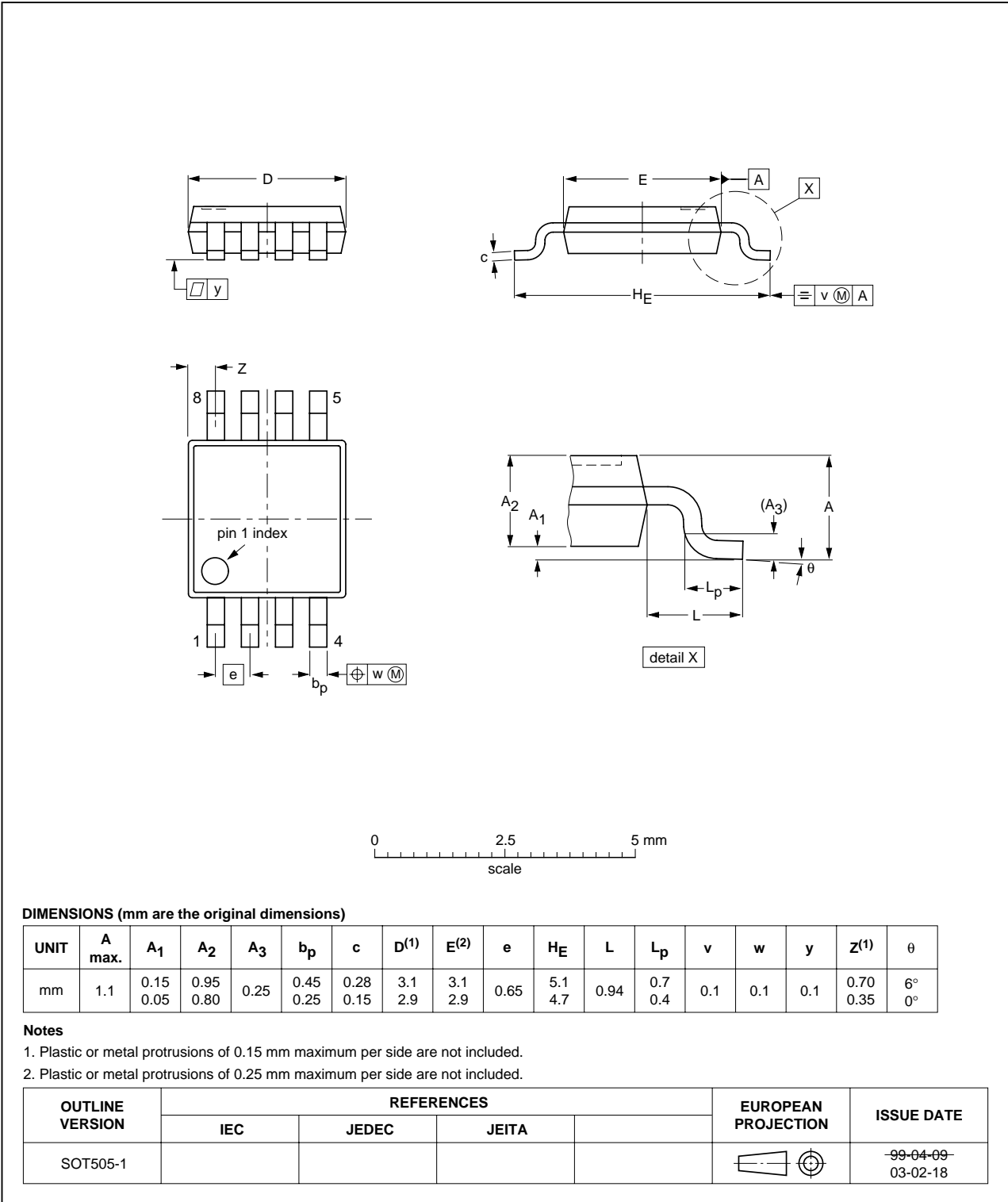

Fig 9. Package outline SOT505-1 (TSSOP8)

SO8: plastic small outline package; 8 leads; body width 3.9 mm

SOT96-1

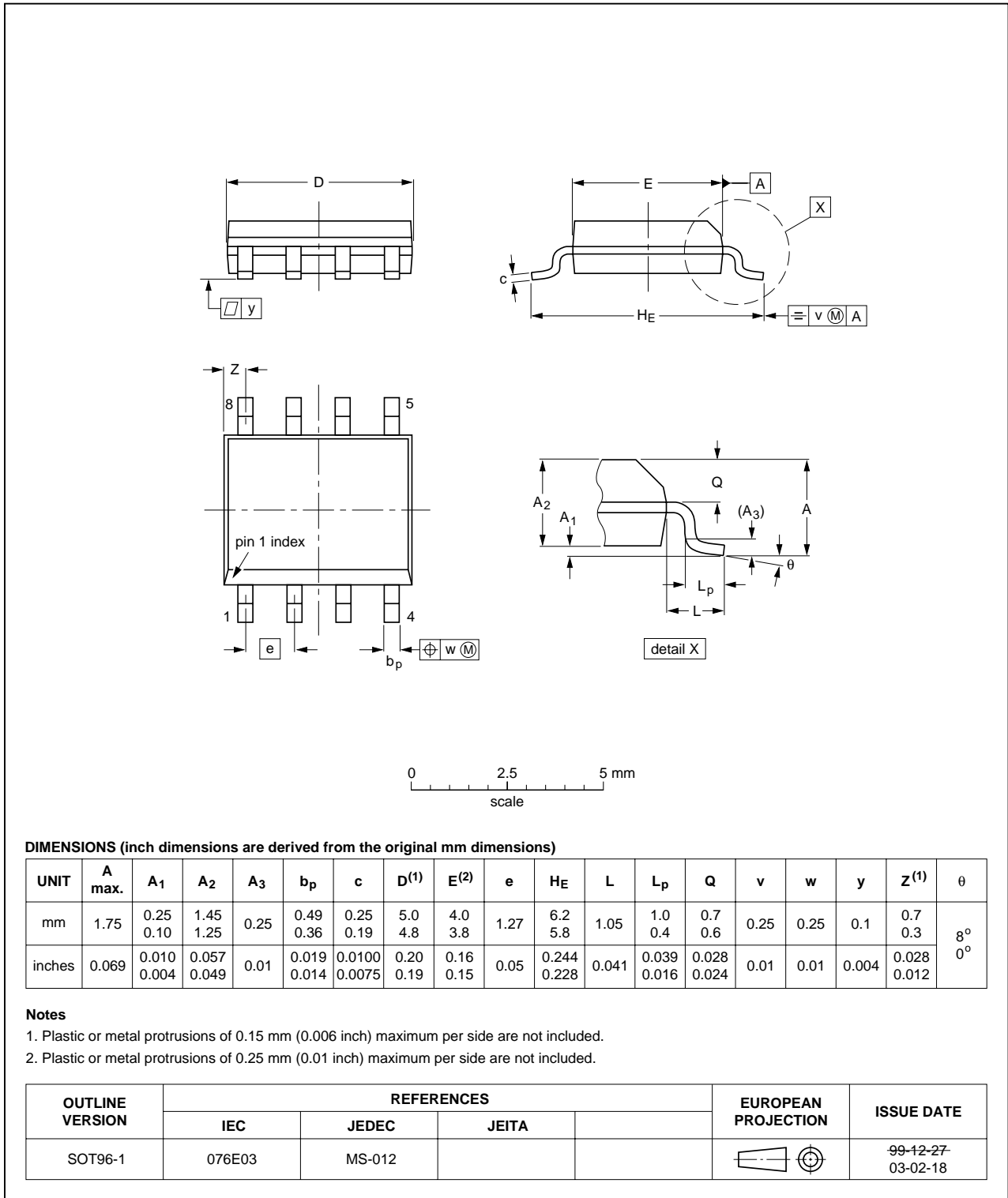

Fig 10. Package outline SOT96-1 (SO8/MS-012)

9. Packing information

Table 10. Packing methods

The indicated -xxx are the last three digits of the 12NC ordering code.^[1]

Type number	Package	Description	Packing quantity	
			1000	2500
PESD5V0L6UAS	SOT505-1	8 mm pitch, 12 mm tape and reel	-	-118
PESD5V0L6US	SOT96-1	8 mm pitch, 12 mm tape and reel	-115	-118

[1] For further information and the availability of packing methods, see [Section 12](#).

10. Revision history

Table 11. Revision history

Document ID	Release date	Data sheet status	Change notice	Supersedes
PESD5V06UAS_US_3	20090818	Product data sheet	-	PESD5V06UAS_US_2
Modifications:		<ul style="list-style-type: none">This data sheet was changed to reflect the new company name NXP Semiconductors, including new legal definitions and disclaimers. No changes were made to the technical content.Table 3 "Discrete pinning": amended		
PESD5V06UAS_US_2	20041109	Product data sheet	-	PESD5V0L6US_1
PESD5V0L6US_1	20040315	Product specification	-	-

11. Legal information

11.1 Data sheet status

Document status ^{[1][2]}	Product status ^[3]	Definition
Objective [short] data sheet	Development	This document contains data from the objective specification for product development.
Preliminary [short] data sheet	Qualification	This document contains data from the preliminary specification.
Product [short] data sheet	Production	This document contains the product specification.

[1] Please consult the most recently issued document before initiating or completing a design.

[2] The term 'short data sheet' is explained in section "Definitions".

[3] The product status of device(s) described in this document may have changed since this document was published and may differ in case of multiple devices. The latest product status information is available on the Internet at URL <http://www.nxp.com>.

11.2 Definitions

Draft — The document is a draft version only. The content is still under internal review and subject to formal approval, which may result in modifications or additions. NXP Semiconductors does not give any representations or warranties as to the accuracy or completeness of information included herein and shall have no liability for the consequences of use of such information.

Short data sheet — A short data sheet is an extract from a full data sheet with the same product type number(s) and title. A short data sheet is intended for quick reference only and should not be relied upon to contain detailed and full information. For detailed and full information see the relevant full data sheet, which is available on request via the local NXP Semiconductors sales office. In case of any inconsistency or conflict with the short data sheet, the full data sheet shall prevail.

11.3 Disclaimers

General — Information in this document is believed to be accurate and reliable. However, NXP Semiconductors does not give any representations or warranties, expressed or implied, as to the accuracy or completeness of such information and shall have no liability for the consequences of use of such information.

Right to make changes — NXP Semiconductors reserves the right to make changes to information published in this document, including without limitation specifications and product descriptions, at any time and without notice. This document supersedes and replaces all information supplied prior to the publication hereof.

Suitability for use — NXP Semiconductors products are not designed, authorized or warranted to be suitable for use in medical, military, aircraft, space or life support equipment, nor in applications where failure or malfunction of an NXP Semiconductors product can reasonably be expected to result in personal injury, death or severe property or environmental

damage. NXP Semiconductors accepts no liability for inclusion and/or use of NXP Semiconductors products in such equipment or applications and therefore such inclusion and/or use is at the customer's own risk.

Applications — Applications that are described herein for any of these products are for illustrative purposes only. NXP Semiconductors makes no representation or warranty that such applications will be suitable for the specified use without further testing or modification.

Limiting values — Stress above one or more limiting values (as defined in the Absolute Maximum Ratings System of IEC 60134) may cause permanent damage to the device. Limiting values are stress ratings only and operation of the device at these or any other conditions above those given in the Characteristics sections of this document is not implied. Exposure to limiting values for extended periods may affect device reliability.

Terms and conditions of sale — NXP Semiconductors products are sold subject to the general terms and conditions of commercial sale, as published at <http://www.nxp.com/profile/terms>, including those pertaining to warranty, intellectual property rights infringement and limitation of liability, unless explicitly otherwise agreed to in writing by NXP Semiconductors. In case of any inconsistency or conflict between information in this document and such terms and conditions, the latter will prevail.

No offer to sell or license — Nothing in this document may be interpreted or construed as an offer to sell products that is open for acceptance or the grant, conveyance or implication of any license under any copyrights, patents or other industrial or intellectual property rights.

Export control — This document as well as the item(s) described herein may be subject to export control regulations. Export might require a prior authorization from national authorities.

Quick reference data — The Quick reference data is an extract of the product data given in the Limiting values and Characteristics sections of this document, and as such is not complete, exhaustive or legally binding.

11.4 Trademarks

Notice: All referenced brands, product names, service names and trademarks are the property of their respective owners.

12. Contact information

For more information, please visit: <http://www.nxp.com>

For sales office addresses, please send an email to: salesaddresses@nxp.com

13. Contents

1	Product profile	1
1.1	General description	1
1.2	Features	1
1.3	Applications	1
1.4	Quick reference data	1
2	Pinning information	2
3	Ordering information	2
4	Marking	2
5	Limiting values	3
6	Characteristics	5
7	Application information	8
8	Package outline	9
9	Packing information	11
10	Revision history	12
11	Legal information	13
11.1	Data sheet status	13
11.2	Definitions	13
11.3	Disclaimers	13
11.4	Trademarks	13
12	Contact information	13
13	Contents	14

Please be aware that important notices concerning this document and the product(s) described herein, have been included in section 'Legal information'.



© NXP B.V. 2009.

All rights reserved.

For more information, please visit: <http://www.nxp.com>

For sales office addresses, please send an email to: salesaddresses@nxp.com

Date of release: 18 August 2009

Document identifier: PESD5V0L6UAS_US_3