

AC Filter 2-Stage, excellent Attenuation

new



Case ME

Case MB

Case MF

See below:  
[Approvals and Compliances](#)

### Description

- Line filter in standard and medical version
- 2 stage
- Compact design
- Very light due to partial potting

### Unique Selling Proposition

- Excellent differential and common-mode attenuation
- Broad band attenuation
- Completely closed steel housing
- Wide temperature range

### Characteristics

- Designed for current applications of 1 - 36 A
- Protection against interference voltage from the mains  
Possible interferences generated in the equipment are strongly attenuated
- Especially designed for industrial applications such as: Frequency Converters, Stepper Motor Drives, UPS-Systems, Inverters
- Suitable for use in equipment according to IEC/UL 62368-1  
Suitable for use in medical equipment according to IEC/UL 60601-1 (1 MOOP, 1 MOPP)

### References

Alternative: High attenuation version [FMBB NEO](#)

### Weblinks

[pdf data sheet](#), [html datasheet](#), [General Product Information](#), [Approvals](#), [Distributor-Stock-Check](#), [Detailed request for product](#), [Microsite](#)

### Technical Data

Ratings IEC	1 - 36A @ Ta 40 °C / 250 VAC; 50Hz
Ratings UL/CSA	1 - 36A @ Ta 40 °C / 125/250VAC; 60Hz
Leakage Current	standard < 6.9 mA (250 V / 50 Hz) low leakage current < 0.15 mA (250 V / 50 Hz) medical (M5) < 5 µA (250 V / 50 Hz) medical (M80) < 80 µA (250 V / 50 Hz)
Dielectric Strength	1.7 kVDC between L-N 2.7 kVDC between L/N-PE Test voltage (2 sec)
Allowable Operation Temperature	-40 °C to 100 °C
Climatic Category	40/100/21 acc. to IEC 60068-1
IP-Protection	rear-side IP20 IEC 60529
Protection Class	Suitable for appliances with protection class I acc. to IEC 61140
Terminal	Quick connect terminal 6.3 x 0.8 mm Bolt and nut M4
Material	Nickel plated steel

Line Filter	Standard and Medical Version, IEC 60939, UL 60939-3, CSA C22.2 no. 8 <a href="#">Technical Details</a>
MTBF	> 200'000h acc. to MIL-HB-217 F

### Approvals and Compliances



Detailed information on product approvals, code requirements, usage instructions and detailed test conditions can be looked up in [Details about Approvals](#)

SCHURTER products are designed for use in industrial environments. They have approvals from independent testing bodies according to national and international standards. Products with specific characteristics and requirements such as required in the automotive sector according to IATF 16949, medical technology according to ISO 13485 or in the aerospace industry can be offered exclusively with customer-specific, individual agreements by SCHURTER.

**Approvals**





The approval mark is used by the testing authorities to certify compliance with the safety requirements placed on electronic products.

Approval Reference Type: FMBB EP

Approval Logo	Certificates	Certification Body	Description
	<a href="#">VDE Approvals</a>	VDE	Certificate Number: 40051449
	<a href="#">UL Approvals</a>	UL	UR File Number: E495089



**Product standards**

Product standards that are referenced

Organization	Design	Standard	Description
	Designed according to	IEC 60939	Passive filters for suppressing electromagnetic interference
	Designed according to	IEC 60127-6	Miniature fuses. Part 6. Fuse-holders for miniature fuse-links
	Designed according to	UL 60939-3	Passive filters for suppressing electromagnetic interference
	Designed according to	CSA C22.2 no. 42	General Use Receptacles, Attachment Plugs, and Similar Wiring Devices
	Designed according to	CSA C22.2 no. 8	Electromagnetic interference (EMI) filters







**Application standards**

Application standards where the product can be used

Organization	Design	Standard	Description
	Suitable for applications acc.	IEC/UL 62368-1	Audio/video, information and communication technology equipment - Part 1: Safety requirements
	Suitable for applications acc.	IEC 60601-1	Medical electrical equipment - Part 1: General requirements for basic safety and essential performance

**Compliances**

The product complies with following Guide Lines

Identification	Details	Initiator	Description
	<a href="#">CE declaration of conformity</a>	SCHURTER AG	The CE marking declares that the product complies with the applicable requirements laid down in the harmonisation of Community legislation on its affixing in accordance with EU Regulation 765/2008.
	<a href="#">UKCA declaration of conformity</a>	SCHURTER AG	The UKCA marking declares that the product complies with the applicable requirements laid down in the British Amendment of Regulation (EC) 765/2008.
	RoHS	SCHURTER AG	Directive RoHS 2011/65/EU, Amendment (EU) 2015/863
	China RoHS	SCHURTER AG	The law SJ / T 11363-2006 (China RoHS) has been in force since 1 March 2007. It is similar to the EU directive RoHS.
	REACH	SCHURTER AG	On 1 June 2007, Regulation (EC) No 1907/2006 on the Registration, Evaluation, Authorization and Restriction of Chemicals 1 (abbreviated as "REACH") entered into force.
	Medical Equipment	SCHURTER AG	Suitable for use in medical equipment according to IEC/UL 60601-1 (1 MOOP, 1 MOPP)

**Dimension [mm]**

Case 09 with quick connect terminals

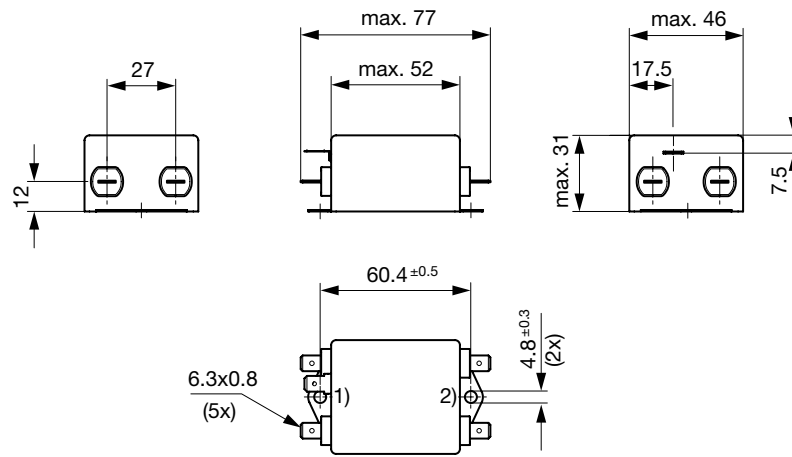

- 1) Line
- 2) Load

Case MB with bolt and nut M4

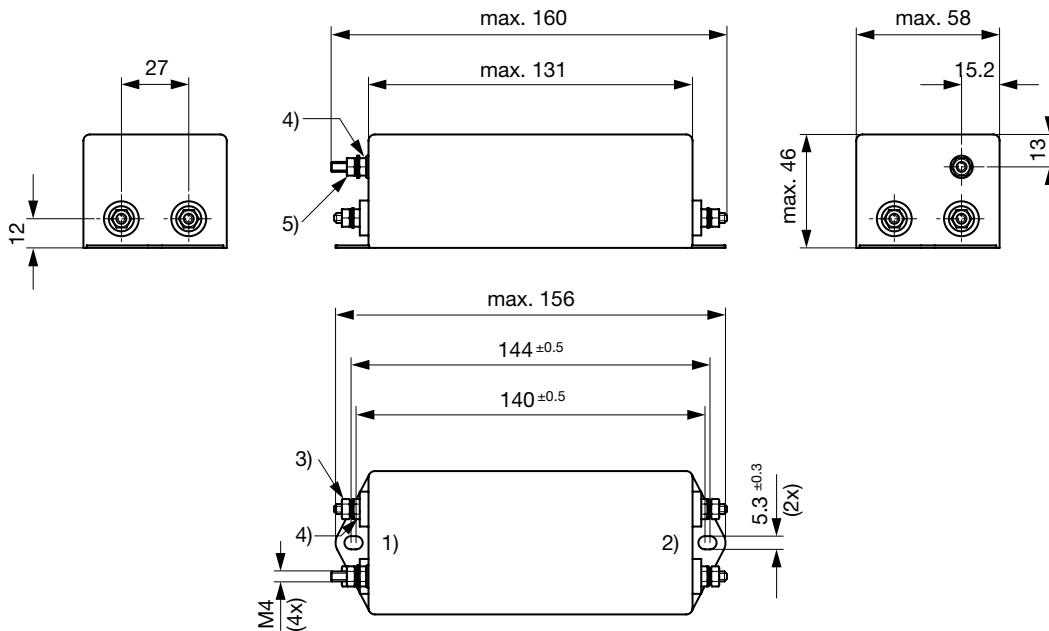

- 1) Line
- 2) Load
- 3) Nut torque 0.8...1 Nm, keep lock-nut fastened
- 4) Lock-nut do not unscrew
- 5) PE: M4x16, 1.2...1.5 Nm, keep lock-nut fastened

Case MC with quick connect terminals

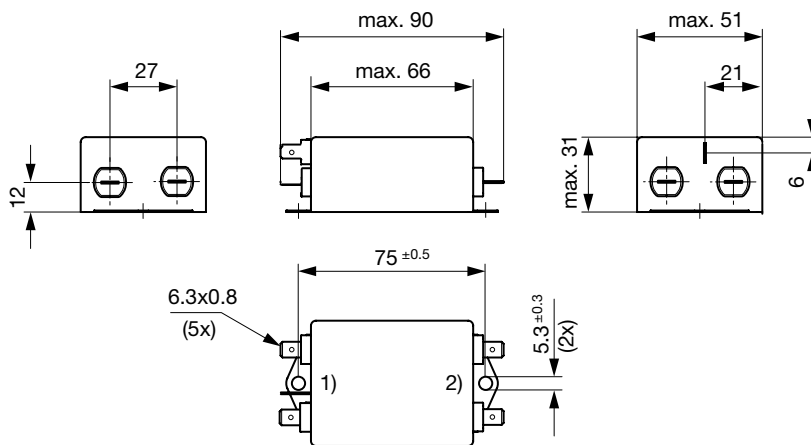

- 1) Line
- 2) Load

Case UB with quick connect terminals

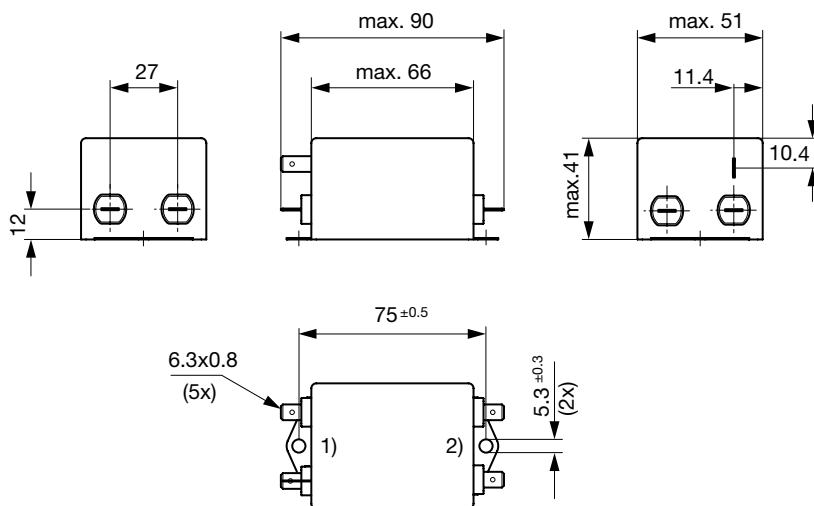

- 1) Line
- 2) Load

Case ME with quick connect terminals

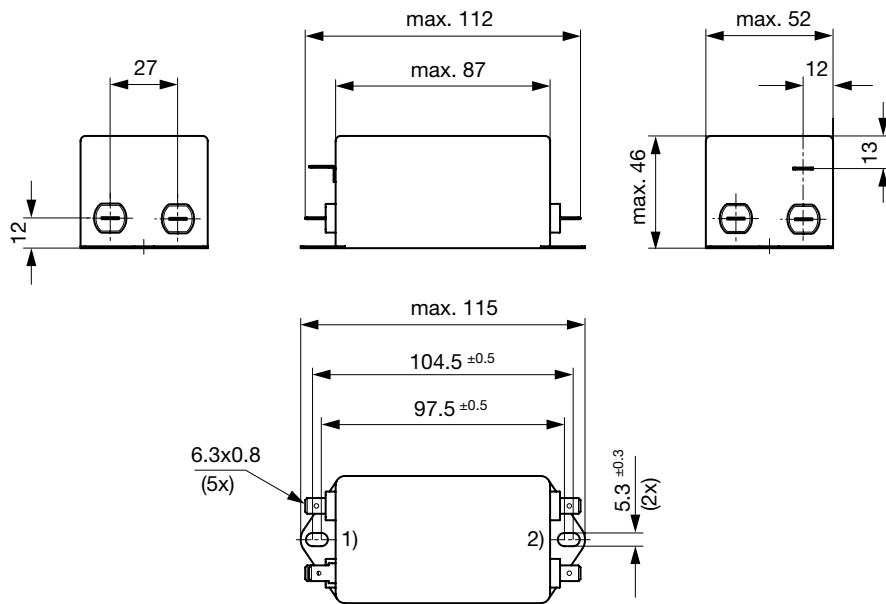

- 1) Line
- 2) Load

Case MF with bolt and nut M4

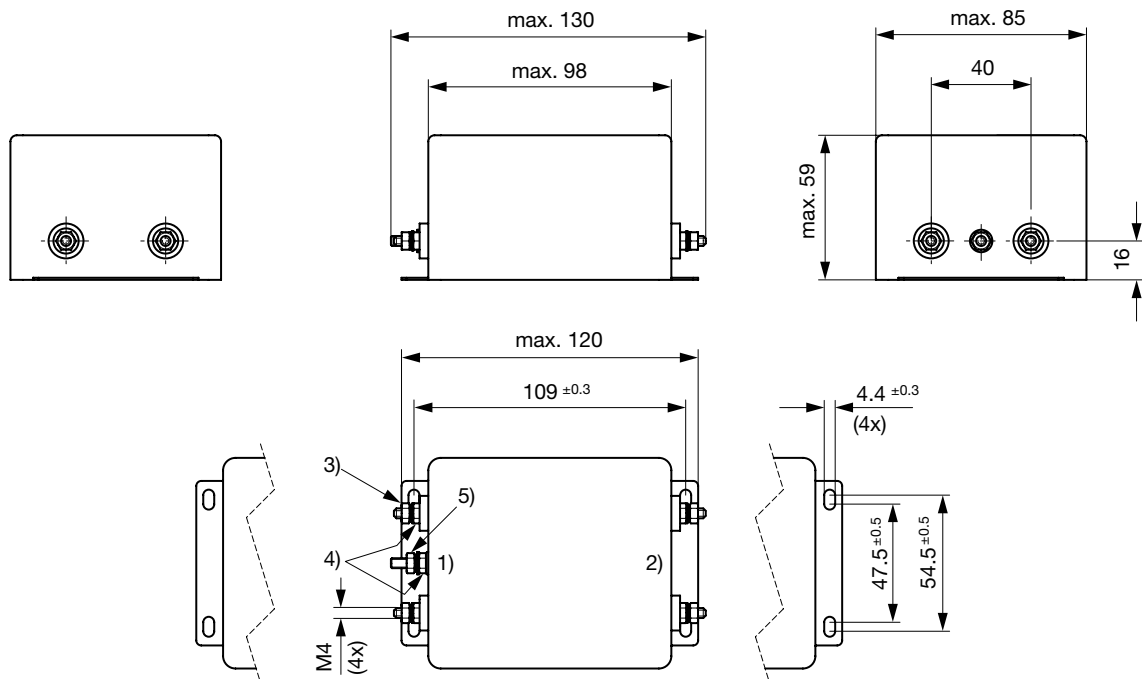

- 1) Line
- 2) Load
- 3) Nut torque 0.8...1 Nm, keep lock-nut fastened
- 4) Lock-nut do not unscrew
- 5) PE: M4x16, 1.2...1.5 Nm, keep lock-nut fastened

Diagrams

Design C, D Standard and medical M80

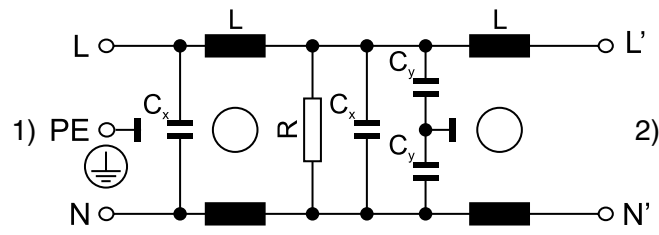

1) Line, 2) Load

Design C, D Medical M5

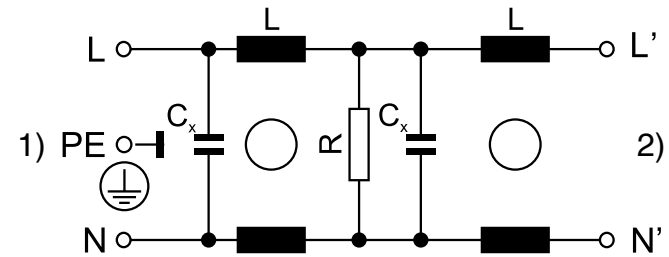

1) Line, 2) Load

Medical M80

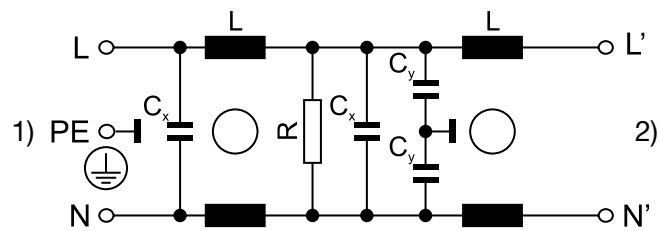

1) Line, 2) Load

**Attenuation Loss** . . . . 0.1/100Ω differential mode ..... 100/0.1Ω differential mode - - - - 50Ω differential mode \_\_\_\_ 50Ω common mode  
 Standard version

1A

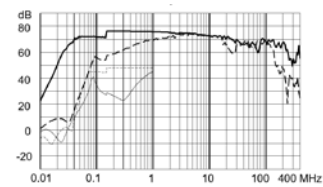

3A

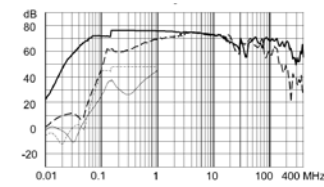

6A

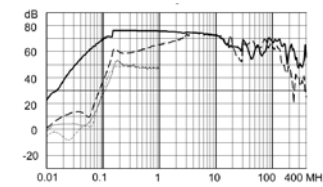

10A

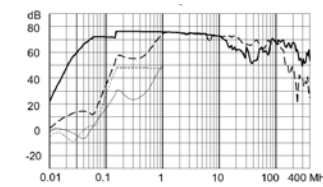

12A

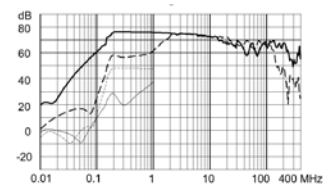

16A

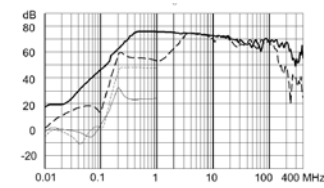

20A

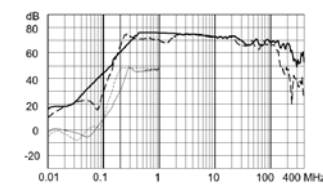

30A

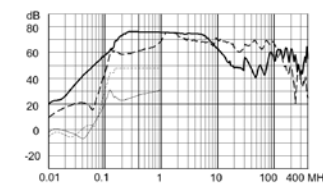

36A

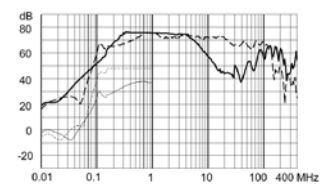



Low leakage current version

1 A

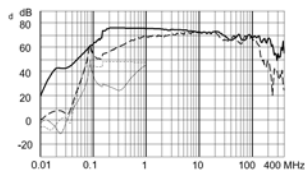

3 A

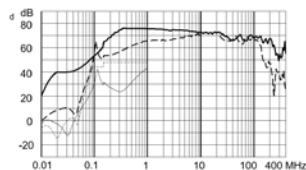

6 A

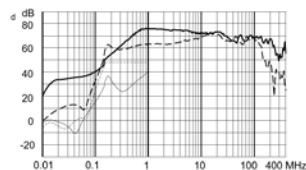

10 A

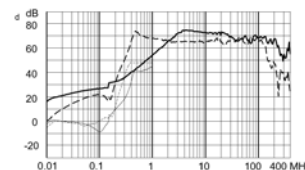

12 A

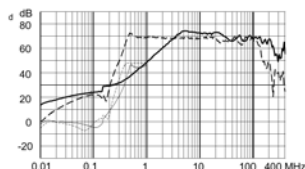

16 A

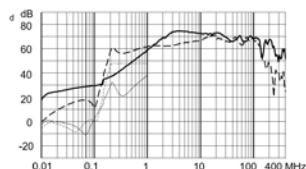

20 A

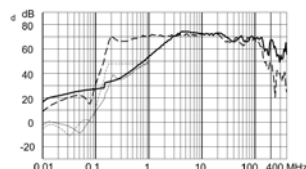

30 A

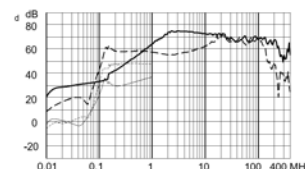

36 A

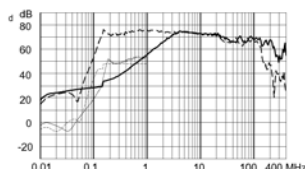

All Variants

Rated current	Filter-Type	Terminal	Lea- kage	Ri	Power Loss	Weight	Housing	Packa- ging	Order Number
[A]			[mA]	[mΩ]	[W]	[g]		[ST]	
1	Standard version	Quick connect terminal 6.3 x 0.8 mm	1.47	600	1.2	125 g	09	15	3-123-509
3	Standard version	Quick connect terminal 6.3 x 0.8 mm	1.47	168	3	128 g	09	15	3-123-510
6	Standard version	Quick connect terminal 6.3 x 0.8 mm	1.47	40	2.88	133 g	09	15	3-123-511
10	Standard version	Quick connect terminal 6.3 x 0.8 mm	6.91	8.6	4.4	198 g	MC	10	3-123-522
12	Standard version	Quick connect terminal 6.3 x 0.8 mm	3.14	6.2	4.15	201 g	MC	10	3-123-523
16	Standard version	Quick connect terminal 6.3 x 0.8 mm	3.14	8.0	4.1	265 g	UB	10	3-123-524
20	Standard version	Quick connect terminal 6.3 x 0.8 mm	3.14	6	4.8	390 g	ME	5	3-123-525
30	Standard version	Bolt and nut M4	3.14	6	10.8	855 g	MF	3	3-123-526
36	Standard version	Bolt and nut M4	3.14	4.2	10.4	890 g	MB	4	3-123-527
1	Low leakage current	Quick connect terminal 6.3 x 0.8 mm	0.15	600	1.2	125 g	09	15	3-123-537
3	Low leakage current	Quick connect terminal 6.3 x 0.8 mm	0.15	168	3	128 g	09	15	3-123-538
6	Low leakage current	Quick connect terminal 6.3 x 0.8 mm	0.15	40	2.88	133 g	09	15	3-123-539
10	Low leakage current	Quick connect terminal 6.3 x 0.8 mm	0.15	8.6	4.4	198 g	MC	10	3-123-540
12	Low leakage current	Quick connect terminal 6.3 x 0.8 mm	0.15	6.2	4.15	201 g	MC	10	3-123-541
16	Low leakage current	Quick connect terminal 6.3 x 0.8 mm	0.15	8.0	4.1	265 g	UB	10	3-123-542
20	Low leakage current	Quick connect terminal 6.3 x 0.8 mm	0.15	6	4.8	390 g	ME	5	3-123-543
30	Low leakage current	Bolt and nut M4	0.15	6	10.8	855 g	MF	3	3-123-544
36	Low leakage current	Bolt and nut M4	0.15	4.2	10.4	890 g	MB	4	3-123-545
1	Medical Version (M5)	Quick connect terminal 6.3 x 0.8 mm	0.005	600	1.2	125 g	09	15	3-123-528
3	Medical Version (M5)	Quick connect terminal 6.3 x 0.8 mm	0.005	168	3	128 g	09	15	3-123-529
6	Medical Version (M5)	Quick connect terminal 6.3 x 0.8 mm	0.005	40	2.88	133 g	09	15	3-123-530
10	Medical Version (M5)	Quick connect terminal 6.3 x 0.8 mm	0.005	8.6	4.4	198 g	MC	10	3-123-531
12	Medical Version (M5)	Quick connect terminal 6.3 x 0.8 mm	0.005	6.2	4.15	201 g	MC	10	3-123-532
16	Medical Version (M5)	Quick connect terminal 6.3 x 0.8 mm	0.005	8.0	4.1	265 g	UB	10	3-123-533
20	Medical Version (M5)	Quick connect terminal 6.3 x 0.8 mm	0.005	6	4.8	390 g	ME	5	3-123-534



Rated current [A]	Filter-Type	Terminal	Leakage [mA]	Ri [mΩ]	Power Loss [W]	Weight [g]	Housing	Packaging [ST]	Order Number
30	Medical Version (M5)	Bolt and nut M4	0.005	6	10.8	855 g	MF	3	3-123-535
36	Medical Version (M5)	Bolt and nut M4	0.005	4.2	10.4	890 g	MB	4	3-123-536
1	Medical Version (M80)	Quick connect terminal 6.3 x 0.8 mm	0.073	600	1.2	125 g	09	15	3-142-126
3	Medical Version (M80)	Quick connect terminal 6.3 x 0.8 mm	0.073	168	3	128 g	09	15	3-142-127
6	Medical Version (M80)	Quick connect terminal 6.3 x 0.8 mm	0.073	40	2.88	133 g	09	15	3-142-128
10	Medical Version (M80)	Quick connect terminal 6.3 x 0.8 mm	0.073	8.6	4.4	198 g	MC	10	3-142-129
12	Medical Version (M80)	Quick connect terminal 6.3 x 0.8 mm	0.073	6.2	4.15	201 g	MC	10	3-142-130
16	Medical Version (M80)	Quick connect terminal 6.3 x 0.8 mm	0.073	8.0	4.1	265 g	UB	10	3-142-131
20	Medical Version (M80)	Quick connect terminal 6.3 x 0.8 mm	0.073	6	4.8	390 g	ME	5	3-142-132
30	Medical Version (M80)	Bolt and nut M4	0.073	6	10.8	855 g	MF	3	3-142-133
36	Medical Version (M80)	Bolt and nut M4	0.073	4.2	10.4	890 g	MB	4	3-142-134

Availability for all products can be searched real-time: <https://www.schurter.com/en/info-center/support-tools/stock-check-distributors>

Leakage current according IEC 60939-1

20A, 30A and 36A medical filter M5 and M80, are only suitable for medical equipment intended for permanently connection to the mains.

## Accessories

### Description



#### DIN\_Rail\_Kit

Mounting accessory for compact 1- and 3-phase filters