

Selection Guide

Part No.	Dice	Lens Type	Iv (mcd) [2] @ 10mA		Viewing Angle [1]
			Min.	Typ.	2θ1/2
L-934EW/1YD	Yellow (GaAsP/GaP)	Yellow Diffused	8	15	40°

Notes:

1. θ1/2 is the angle from optical centerline where the luminous intensity is 1/2 of the optical peak value.
2. Luminous intensity/ luminous Flux: +/-15%.

Electrical / Optical Characteristics at TA=25°C

Symbol	Parameter	Device	Typ.	Max.	Units	Test Conditions
λ _{peak}	Peak Wavelength	Yellow	590		nm	I _F =20mA
λ _D [1]	Dominant Wavelength	Yellow	588		nm	I _F =20mA
Δλ _{1/2}	Spectral Line Half-width	Yellow	35		nm	I _F =20mA
C	Capacitance	Yellow	20		pF	V _F =0V;f=1MHz
V _F [2]	Forward Voltage	Yellow	2.1	2.5	V	I _F =20mA
I _R	Reverse Current	Yellow		10	uA	V _R = 5V

Notes:

1. Wavelength: +/-1nm.
2. Forward Voltage: +/-0.1V.

Absolute Maximum Ratings at TA=25°C

Parameter	Yellow	Units
Power dissipation	75	mW
DC Forward Current	30	mA
Peak Forward Current [1]	140	mA
Reverse Voltage	5	V
Operating/Storage Temperature	-40°C To +85°C	
Lead Solder Temperature [2]	260°C For 3 Seconds	
Lead Solder Temperature [3]	260°C For 5 Seconds	

Notes:

1. 1/10 Duty Cycle, 0.1ms Pulse Width.
2. 2mm below package base.
3. 5mm below package base.

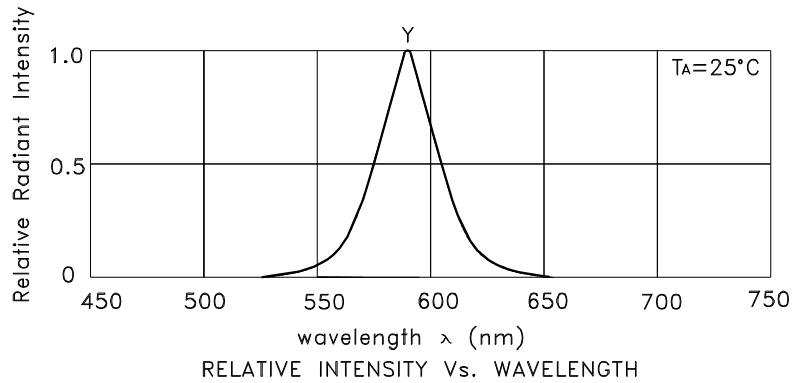

Yellow

L-934EW/1YD

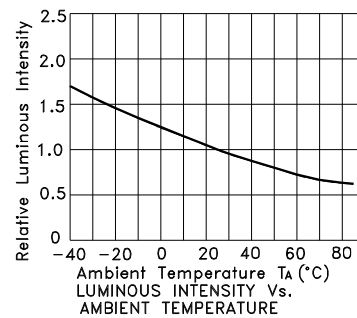
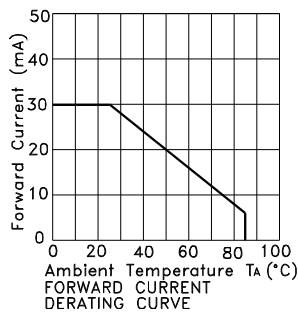
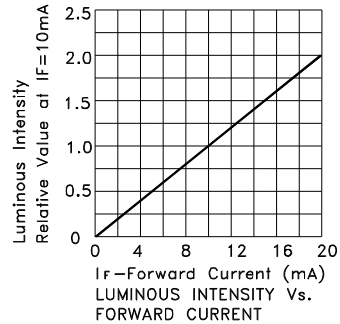
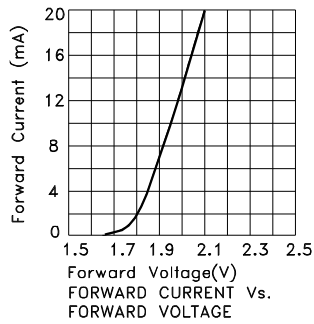

Kingbright

PACKING & LABEL SPECIFICATIONS

L-934EW/1YD

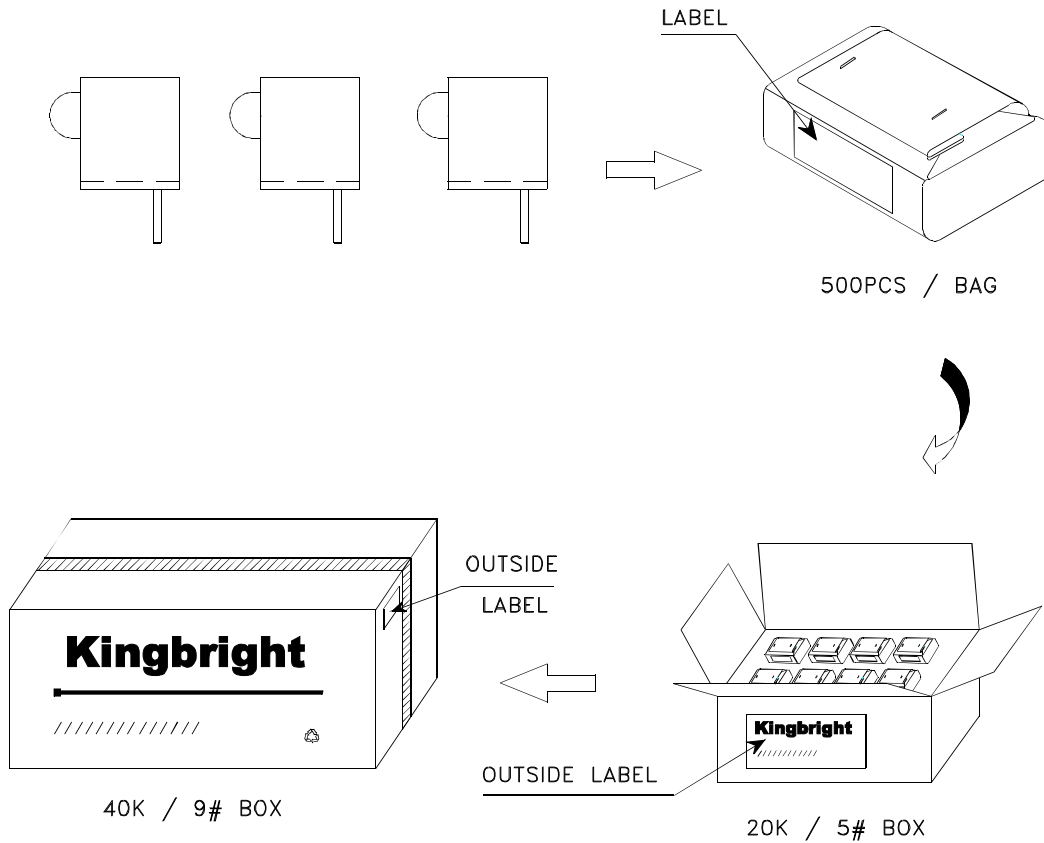

<h1>Kingbright</h1>	
P/NO: L-934EWxxx	
QTY: 500 pcs	Q.C. Q C xx xx xxxx PASSED
S/N: XXXX	
CODE: XXX	
LOT NO:	
 xxxxxxxxxxxxxxxxxxxxxxxxxxxx	
RoHS Compliant	

PRECAUTIONS

- The lead pitch of the LED must match the pitch of the mounting holes on the PCB during component placement. Lead-forming may be required to insure the lead pitch matches the hole pitch. Refer to the figure below for proper lead forming procedures.

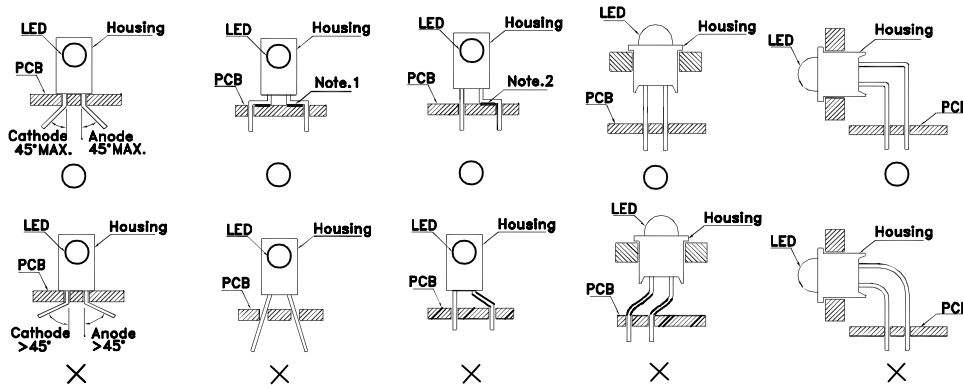

”O” Correct mounting method ”X” Incorrect mounting method

- During soldering, component covers and holders should leave clearance to avoid placing damaging stress on the LED during soldering.

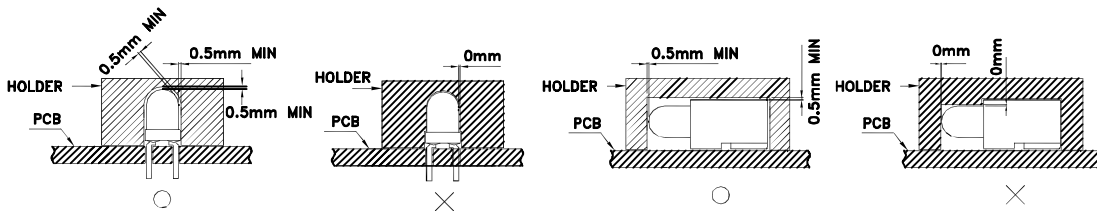

- The tip of the soldering iron should never touch the lens epoxy.
- Through-hole LEDs are incompatible with reflow soldering.
- If the LED will undergo multiple soldering passes or face other processes where the part may be subjected to intense heat, please check with Kingbright for compatibility.
- Recommended Wave Soldering Profile for Kingbright Thru-Hole Products

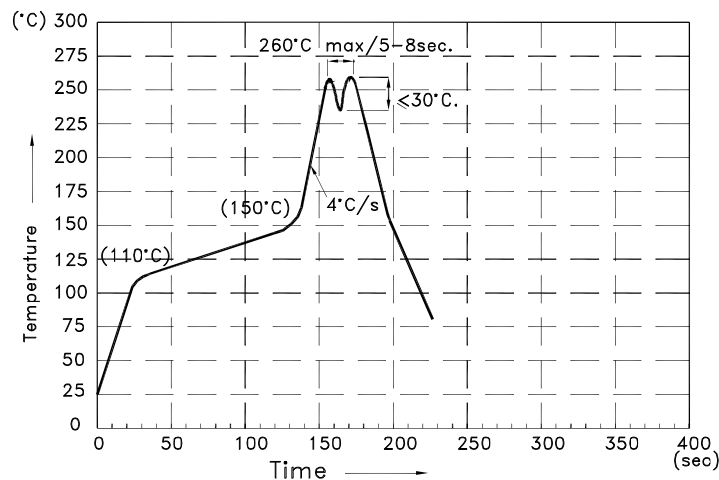

NOTES:

- Recommend the wave temperature 245°C~260°C. The maximum soldering temperature should be less than 260°C.
- Do not apply stress on epoxy resins when temperature is over 85°C.
- The soldering profile apply to the lead free soldering (Sn/Cu/Ag alloy).
- During wave soldering, the PCB top-surface temperature should be kept below 105°C.
- No more than once.