

2J7024Ma

CELLULAR/LTE MIMO Magnetic Mount

Key Features

- Cable 1 and 2: CELLULAR / LTE
- Magnetic Mount
- Heavy Duty antenna
- High Performance
- Ground Plane Independent
- Customizable Cable and Connector
- Dimensions: Ø 96 × 102 mm
- Certificates: IP67, IP69, IK09



1. Antenna and electrical specifications

Cable 1

Parameters	CELLULAR / LTE Antenna		
Standards	2G,3G and 4G		
Band (MHz)	700/850/900	1700/1800/1900/2100	2600
Frequency (MHz)	698-960	1710-2170	2500-2700
Return Loss (dB)	~-12.0	~-14.2	~-14.7
VSWR	~1.7:1	~1.7:1	~1.5:1
Efficiency (%)	~50.7	~52.6	~50.6
Peak Gain (dBi)	~1.3	~4.8	~5.0
Average Gain (dB)	~-3.0	~-2.8	~-3.2
Impedance (Ohm)	50		
Polarisation	Linear		
Radiation Pattern	Omni-Directional		
Max. Input Power (W)	25		
Connector Type	SMA-Male Standard (Other Connectors Available)		
Cable Length	300 cm Standard (Any Cable Length Available)		
Cable Type	LL195 Standard (Other Cables Available)		

Cable 2

Parameters	CELLULAR / LTE Antenna		
Standards	2G,3G and 4G		
Band (MHz)	700/850/900	1700/1800/1900/2100	2600
Frequency (MHz)	698-960	1710-2170	2500-2700
Return Loss (dB)	~-12.5	~-14.1	~-16.4
VSWR	~1.7:1	~1.7:1	~1.4:1
Efficiency (%)	~50.7	~52.7	~58.4
Peak Gain (dBi)	~-0.9	~4.4	~5.5
Average Gain (dB)	~-3.2	~-2.8	~-2.3
Impedance (Ohm)	50		
Polarisation	Linear		
Radiation Pattern	Omni-Directional		
Max. Input Power (W)	25		
Connector Type	SMA-Male Standard (Other Connectors Available)		
Cable Length	300 cm Standard (Any Cable Length Available)		
Cable Type	LL195 Standard (Other Cables Available)		

Antenna Measurement Conditions:

Mounted on Metal Plate of 30 × 30 cm

200 cm of LL195 Cable

Measured in Certified CTIA 3D Anechoic Chamber

2. Mechanical and environmental specifications

Specifications	2J7024Ma
Mounting Type	Magnetic Mount
Dimensions (mm)	Ø 96 × 102
Radome	ASA
Radome color	White, Black
Antenna Base	Alluminium alloy
Operating Temperature (C)	-40 to +85
Storage Temperature (C)	-40 to +85
Substance Compliance	RoHS
Certificates	IP67, IP69, IK09

3. Antenna parameters

Table 1: CELLULAR/LTE

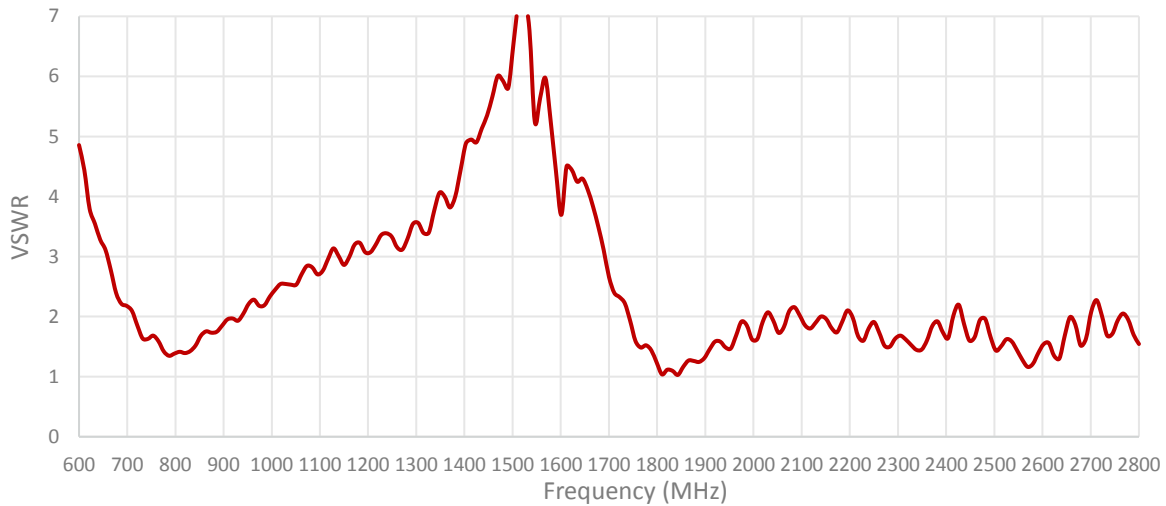
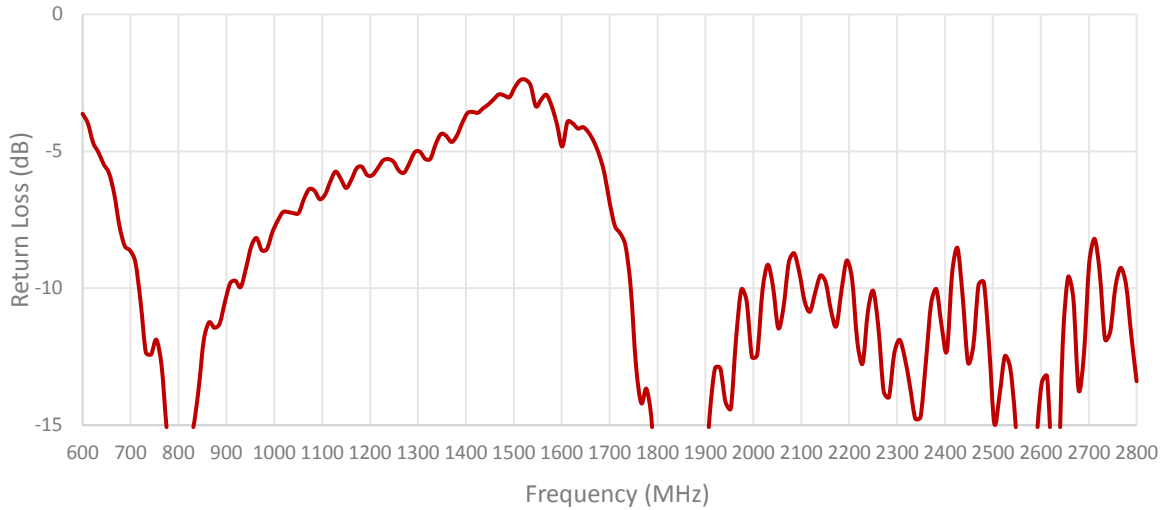

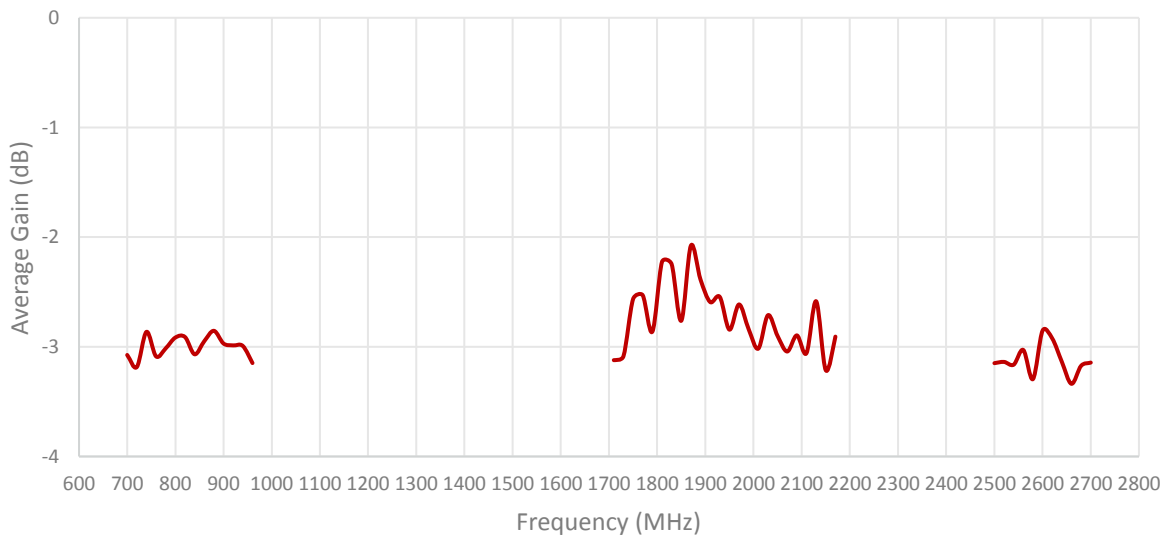
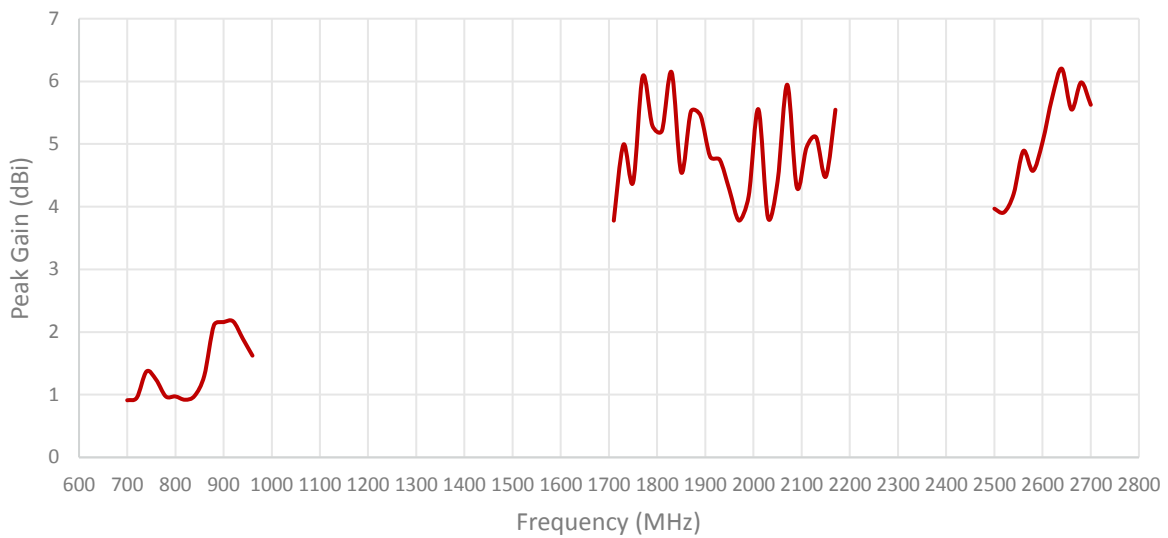
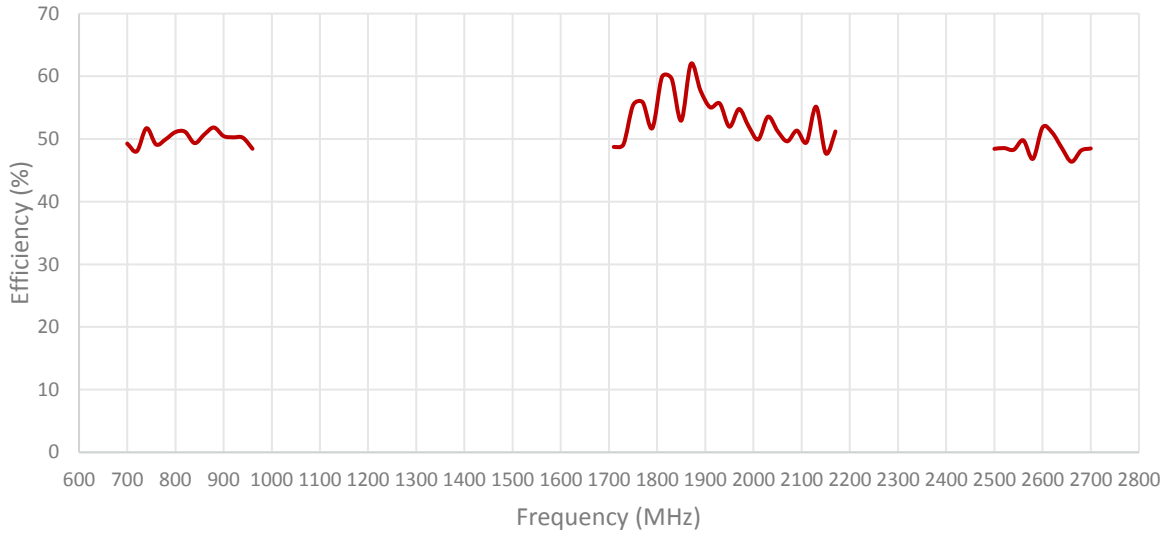
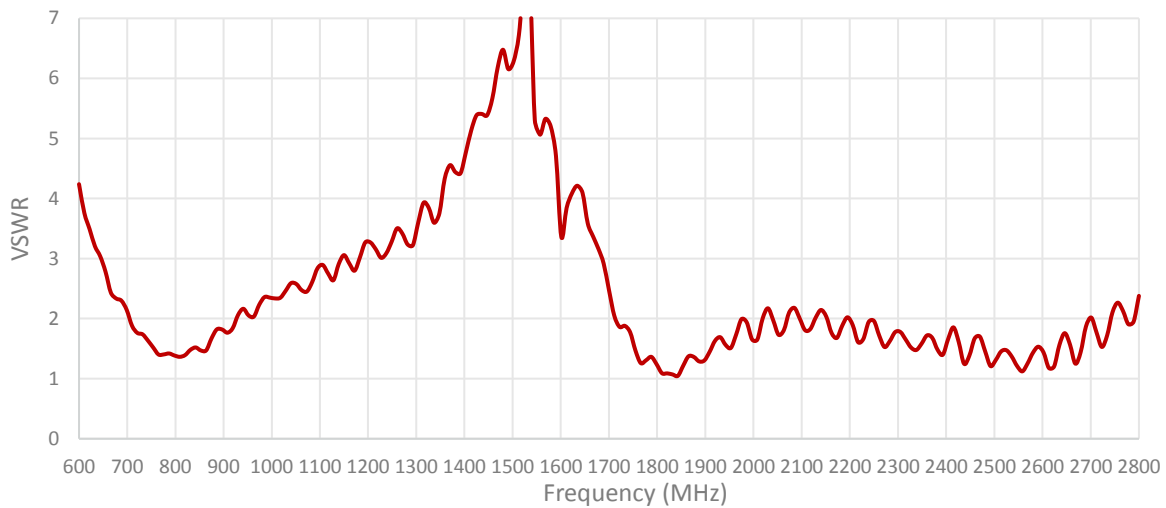
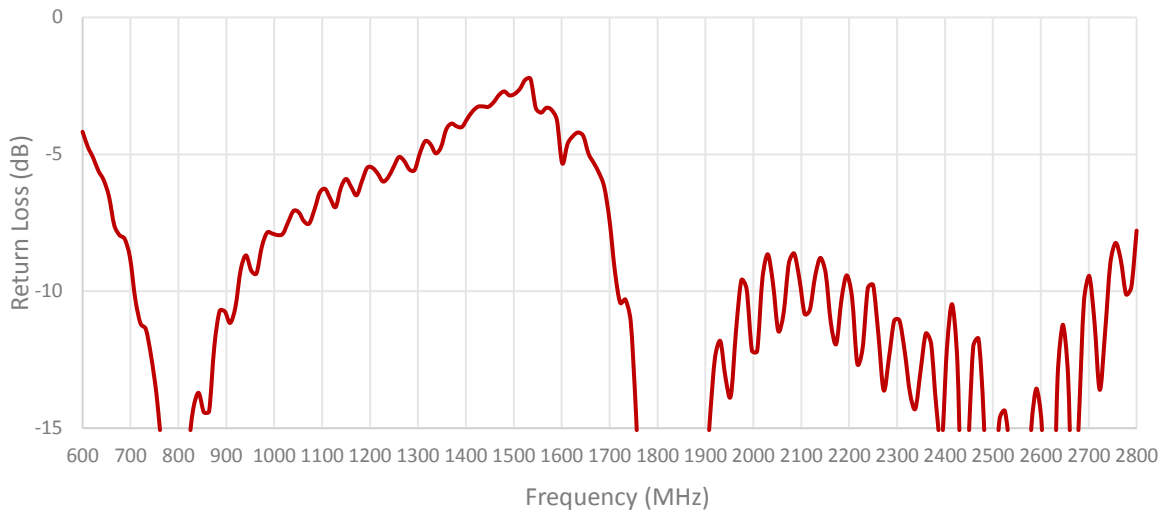
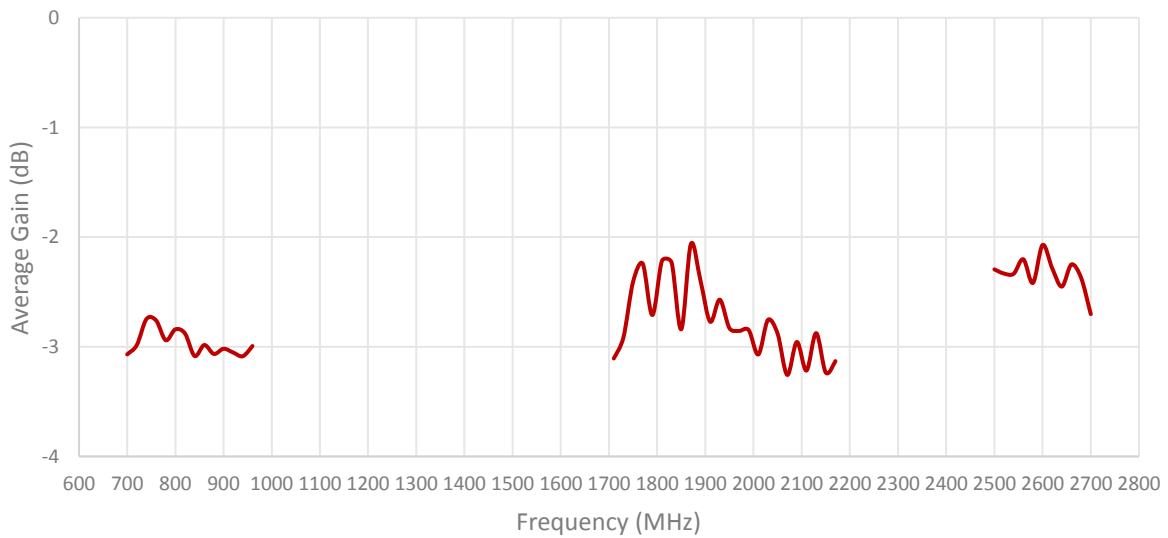
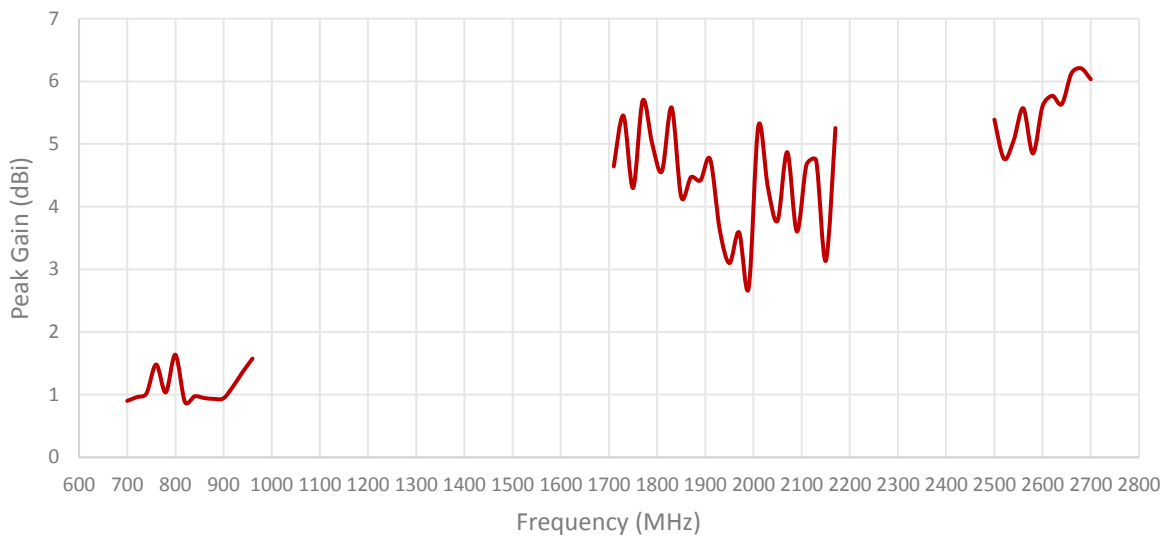
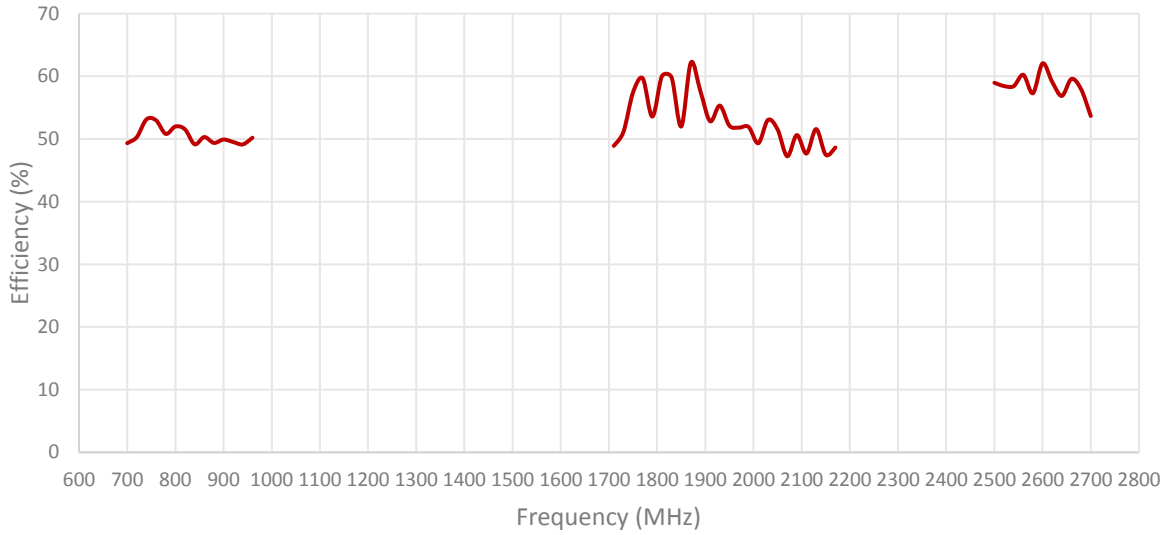
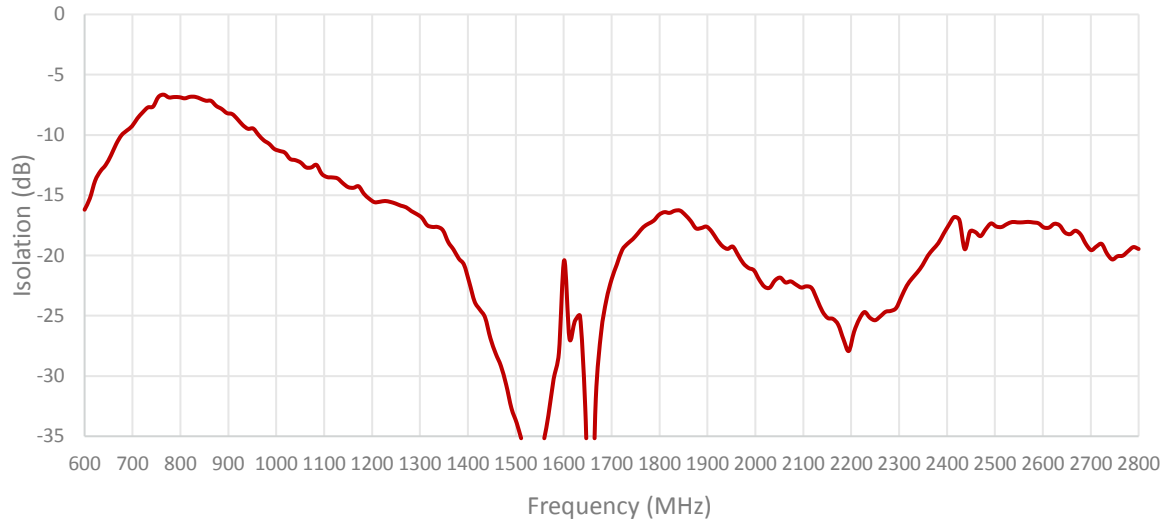

Table 2: CELLULAR/LTE





ISOLATION FOR CABLES 1 AND 2



ENVELOPE CORRELATION COEFFICIENT FOR CABLES 1 AND 2

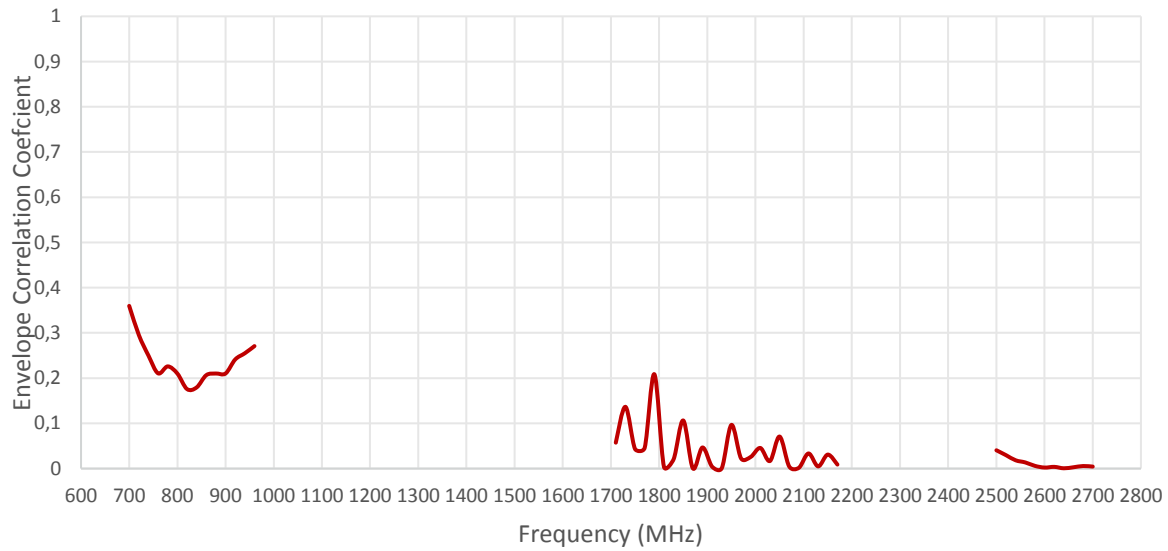

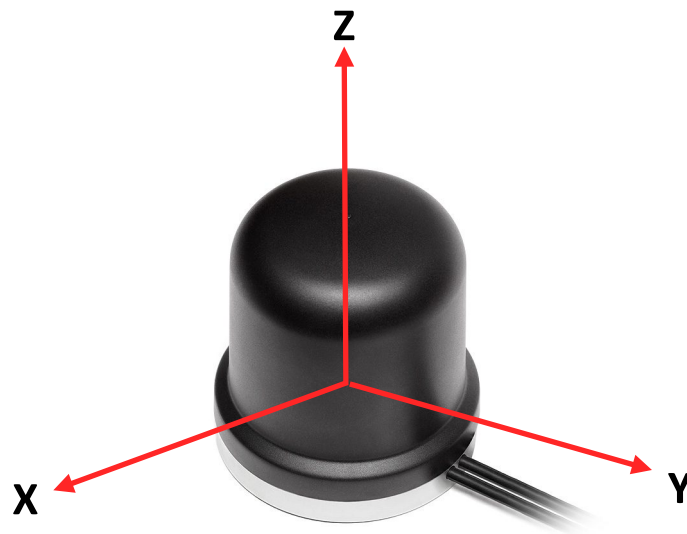

Radiation pattern reference

Cable 1: CELLULAR/LTE

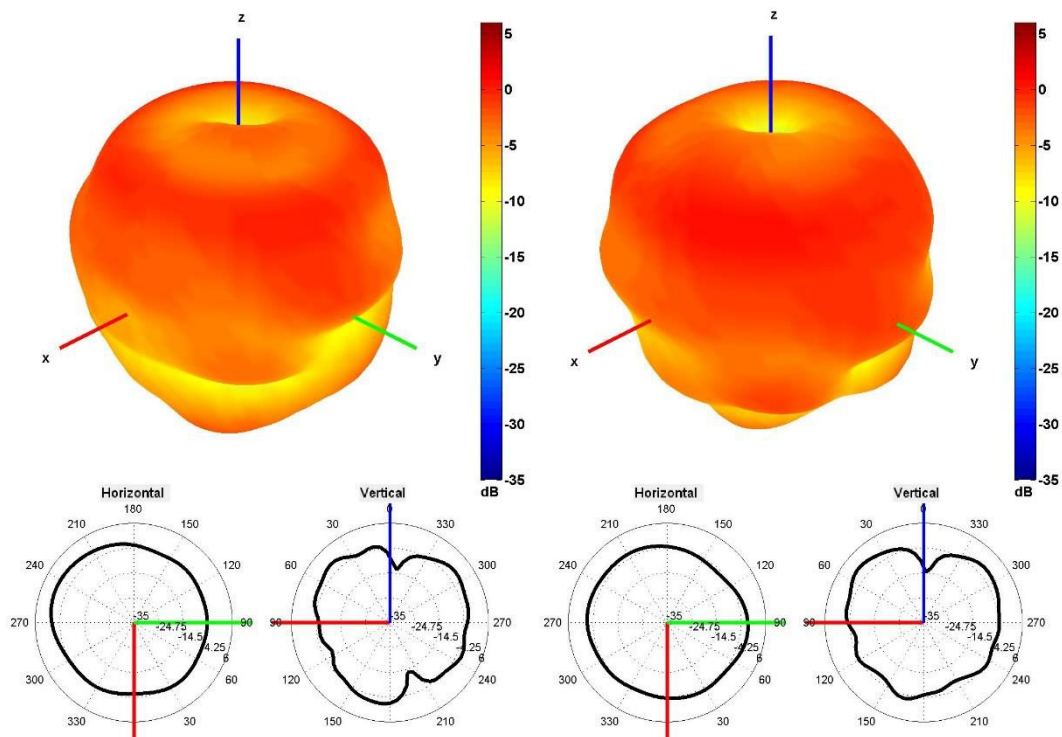

750 and 850 MHz Radiation pattern

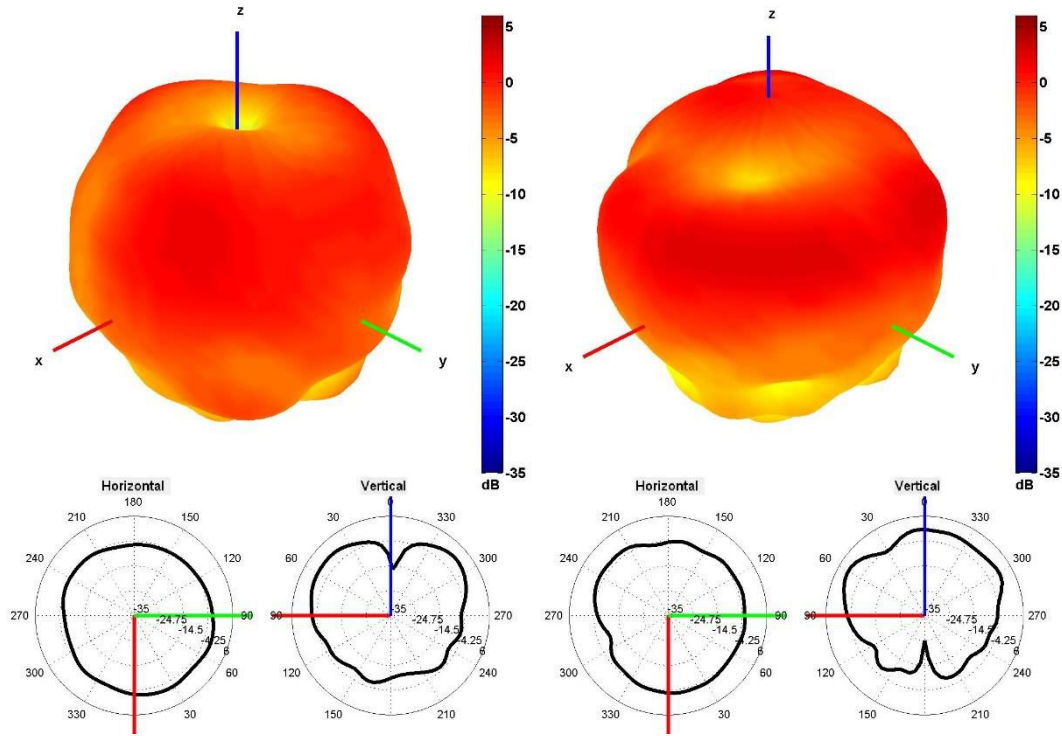

940 and 1750 MHz Radiation pattern

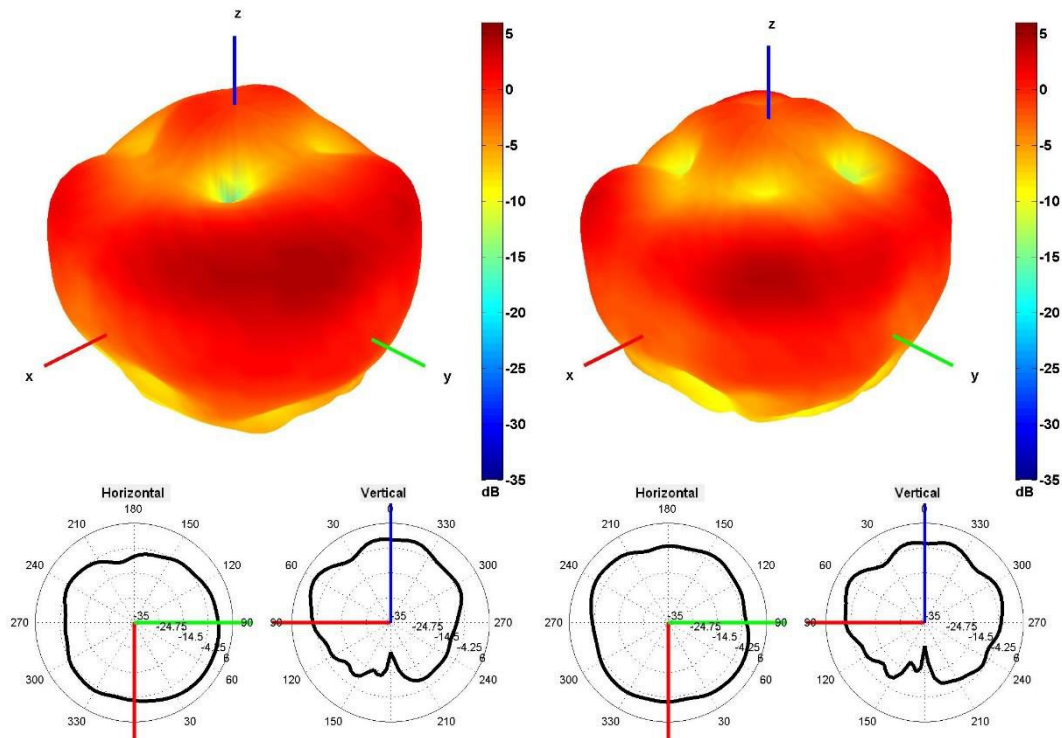

1850 and 1950 MHz Radiation pattern

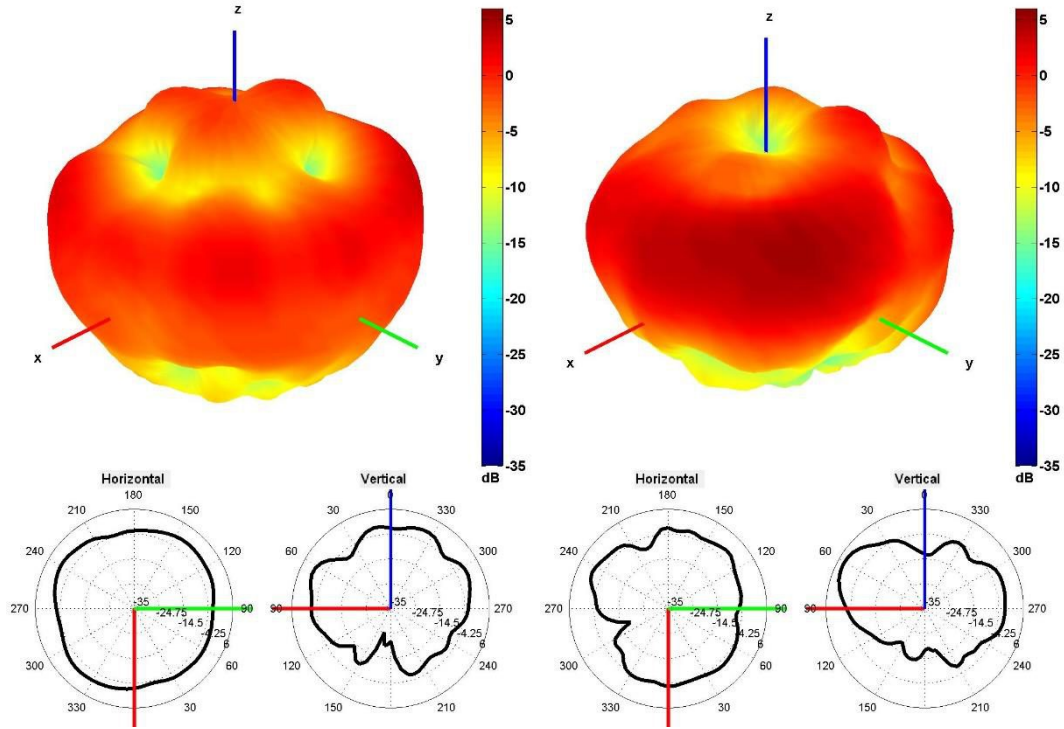

2100 and 2600 MHz Radiation pattern

Table 2: CELLULAR/LTE

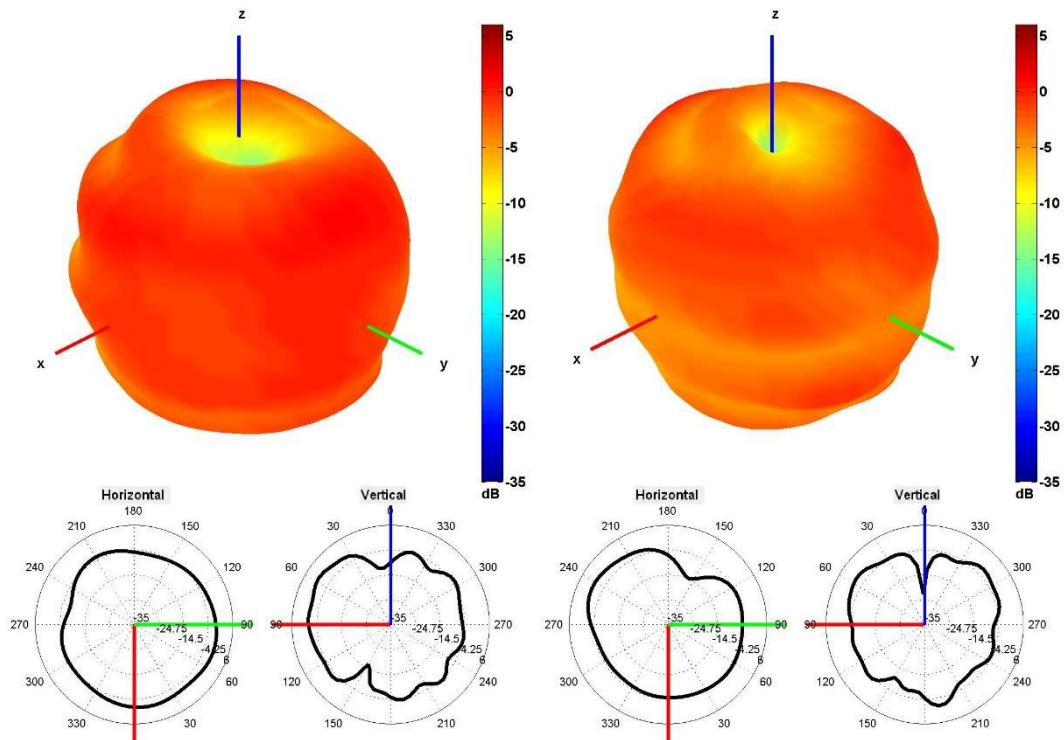

750 and 850 MHz Radiation pattern

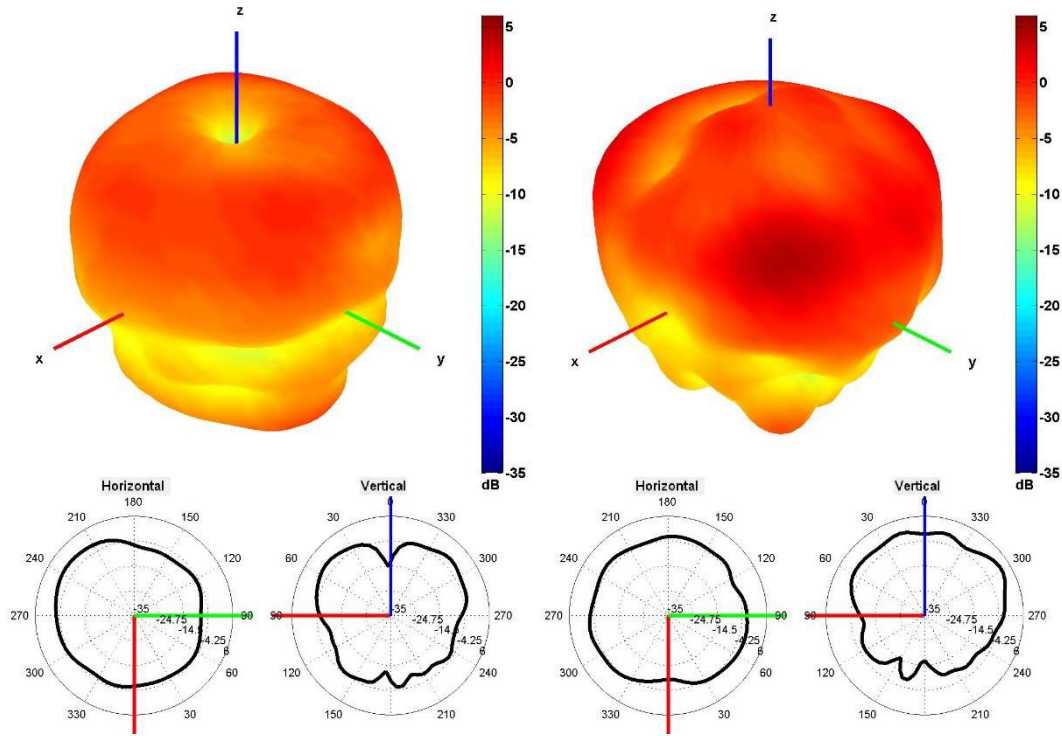

940 and 1750 MHz Radiation pattern

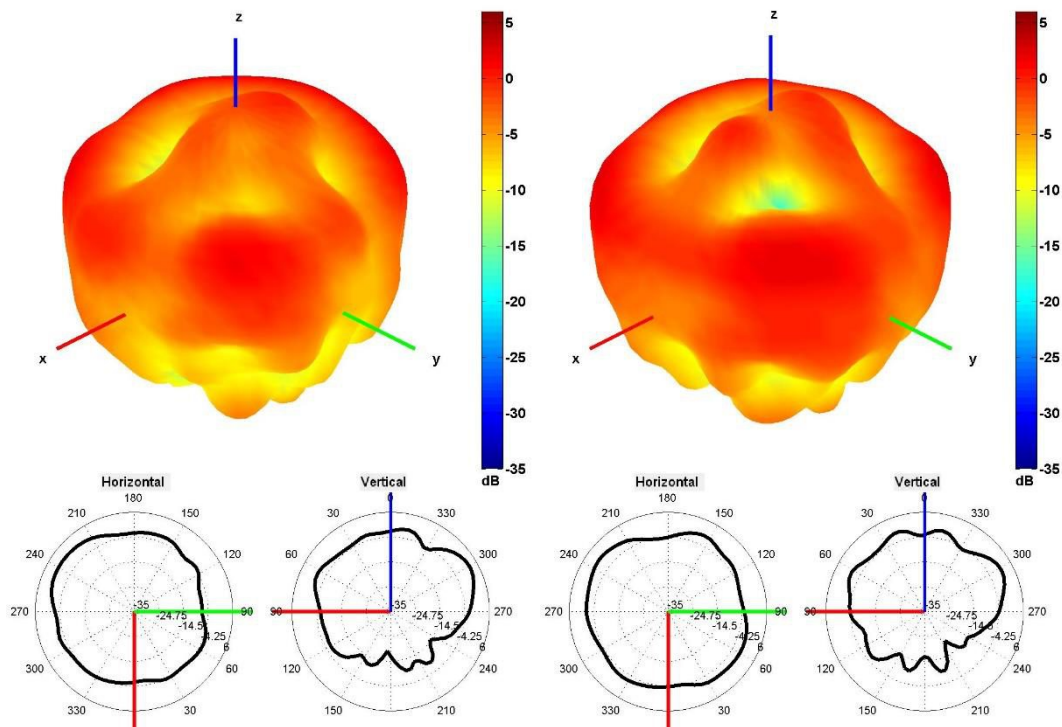

1850 and 1950 MHz Radiation pattern

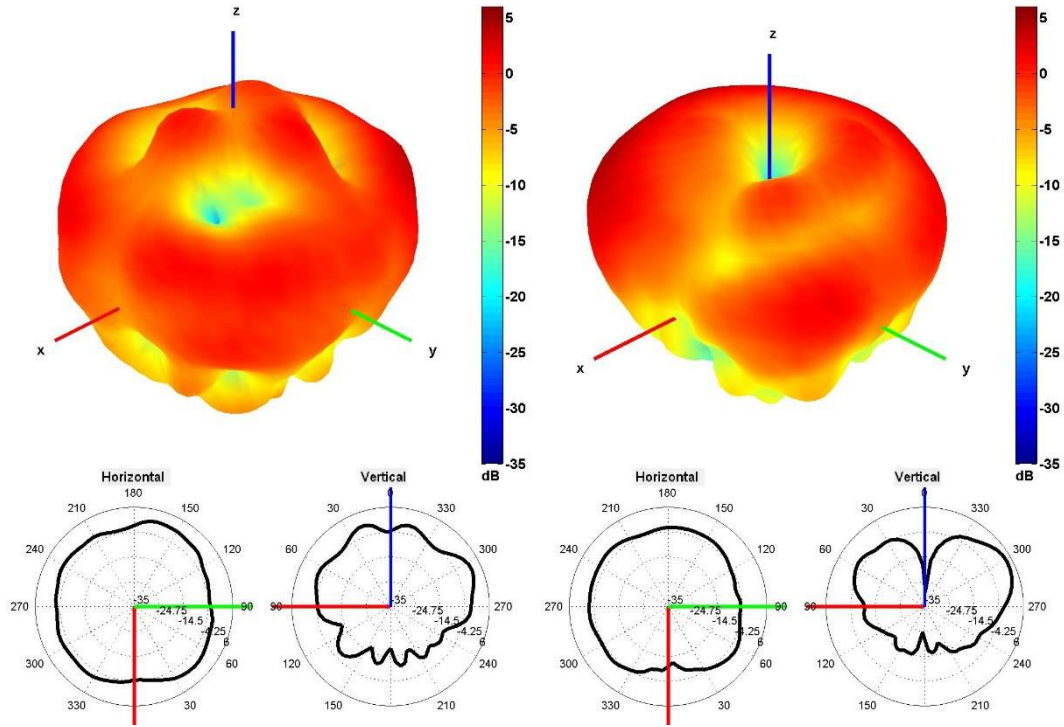

2100 and 2600 MHz Radiation pattern

4. Antenna drawings

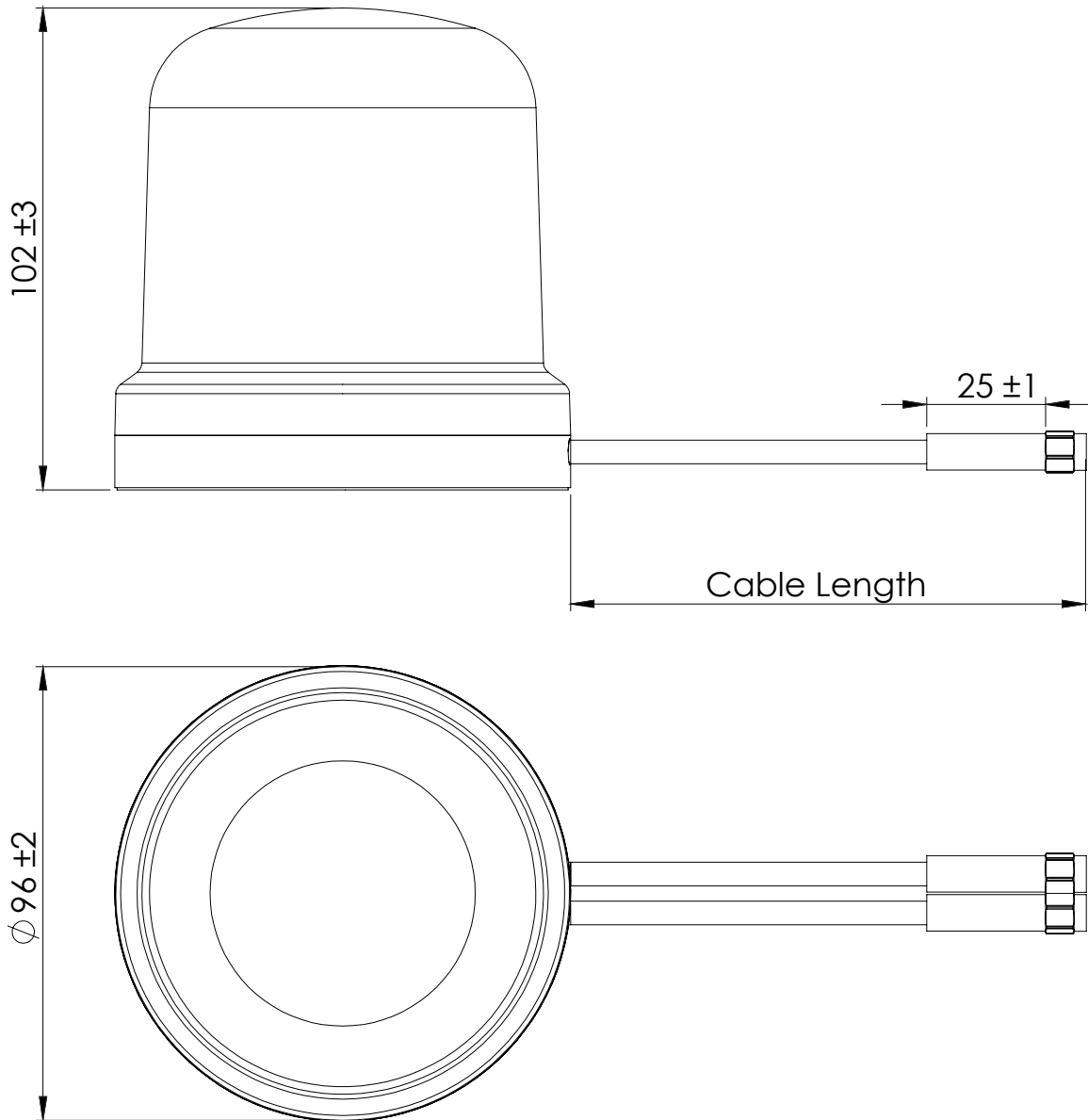

Note: Dimensions are in millimeters

5. Jumper cables drawings - Optional

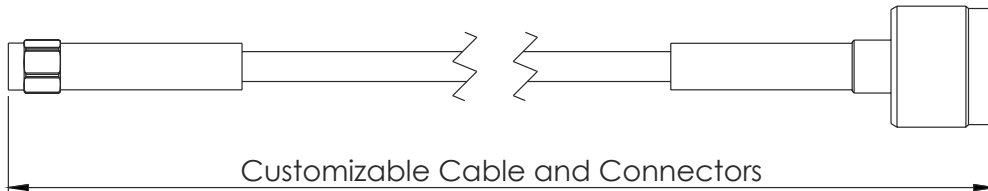

C318N-LMR195-C91N OST - 2x

Cable 1 and 2: CELLULAR/LTE - Shrink tube Orange d6,4

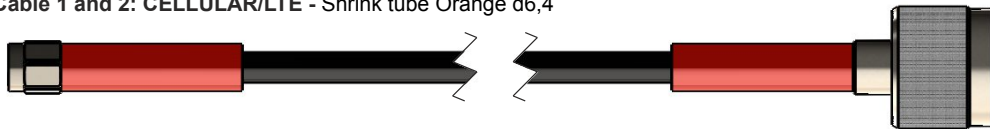

6. Antenna Images

