

Data sheet | Item number: 787-1668/000-080

Electronic circuit breaker; 8-channel; 24 VDC input voltage; adjustable 1 ... 10 A; IO-Link

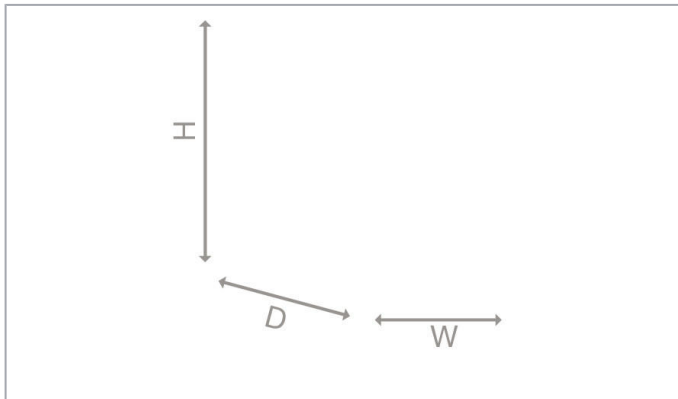

www.wago.com/787-1668/000-080

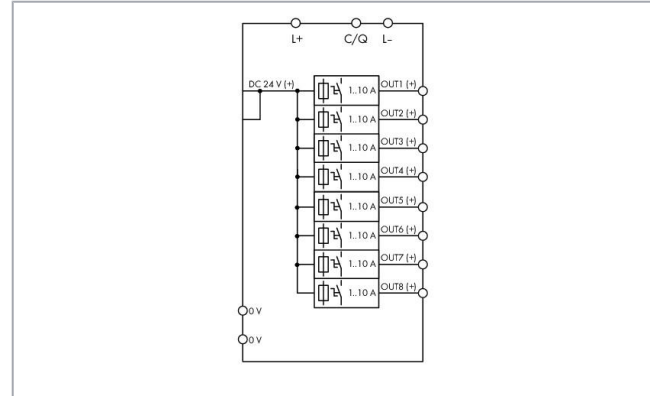
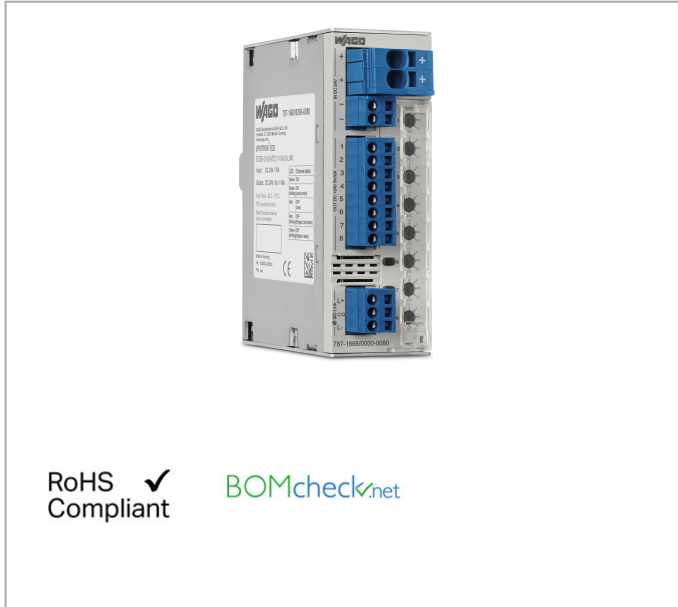

Item description

Features:

- Space-saving ECB with eight channels
- Nominal current: 1 ... 10 A (adjustable for each channel via sealable selector switch or IO-Link interface)
- Switch-on capacity > 50000 μ F per channel
- One illuminated, three-colored button per channel simplifies switching (on/off), resetting, and on-site diagnostics
- Time-delayed switching of channels

Subject to changes. Please also observe the further product documentation!

WAGO Kontakttechnik GmbH & Co. KG
Hansastr. 27
32423 Minden
Phone: +49571 887-0 | Fax: +49571 887-169
Email: info.de@wago.com | Web: www.wago.com

Do you have any questions about our products?
We are always happy to take your call at +49 (571) 887-44222.



- Status message and current measurement of each individual channel via IO-Link interface
- Switch on/off each channel separately via IO-Link interface

Data

Technical data

Input

Nominal input voltage $U_{i\text{ nom}}$	DC 24 V
Input voltage range	DC 18 ... 30 V

Output

Total number of channels (module)	8
Nominal output voltage $U_{o\text{ nom}}$	8 x DC 24 V
Output voltage range	DC 18 ... 30 V (U_e - voltage drop)
Voltage drop	≤ 200 mV (Input (+))
Nominal output current $I_{o\text{ nom}}$	8 x 1 / 2 / 3 / 4 / 6 / 8 / 10 A (Adjustable for each channel via IO-Link interface; 1, 2, 4, 6, 10 A adjustable for each channel via selector switch)
Default setting	DC 10 A; switched off
Trip time	16 ms ... 100 s (Load-dependent)
Switch-on capacity	> 50000 μ F per channel
Switch-on behavior	Time-delayed channel switching (load-dependent, min. 50 ms / max. 5 s)
Active current limitation	no

Signaling and communication

Signaling	8 x LED (green/red/orange) 1 x IO-Link interface
Operation status indicator	Green LED (channel OK) Red LED (tripped channel)
Remote input	Switching on/off any number of channels via IO-Link interface

Efficiency/power losses

Power loss P_l	≤ 1.3 W (No load); ≤ 20 W (8 x 10 A)
Efficiency (typ.)	99 %

Subject to changes. Please also observe the further product documentation!

Circuit protection

Internal fuse	T 15 A per channel
---------------	--------------------

Safety and protection

Isolation voltage (connectors – housing)	DC 0.5 kV
Protection class	III
Protection type	IP20 (per EN 60529)
Reverse voltage protection	No
Resistance to reverse feed	≤ DC 35 V
Pollution degree	2
Transient suppression (primary)	Suppressor diode (33 V)
Parallel operation of single channels	Not permitted
Series operation	No
MTBF	> 500,000 h (per IEC 61709)

Connection data

Connection type (1)	Input (+)
Connection technology	Push-in CAGE CLAMP®
WAGO Connector	WAGO 831 Series
Solid conductor	0.5 ... 10 mm ² / 20 ... 8 AWG
Fine-stranded conductor	0.5 ... 10 mm ² / 20 ... 8 AWG
Strip length	13 ... 15 mm / 0.51 ... 0.59 inch
Connection type 2	Input (-); Output; Signaling
Connection technology 2	CAGE CLAMP®
WAGO Connector 2	WAGO 721 Series
Solid conductor 2	0.08 ... 2.5 mm ² / 28 ... 12 AWG
Fine-stranded conductor 2	0.08 ... 2.5 mm ² / 28 ... 12 AWG
Strip length 2	8 ... 9 mm / 0.31 ... 0.35 inch

Physical data

Width	42 mm / 1.654 inch
Height	127 mm / 5 inch
Depth from upper edge of DIN-rail	142.5 mm / 5.61 inch

Subject to changes. Please also observe the further product documentation!

Mechanical data

Mounting type	DIN-35 rail
---------------	-------------

Material data

Weight	440 g
--------	-------

Environmental requirements

Surrounding air temperature (operation)	-25 ... 70 °C
Surrounding air temperature (storage)	-25 ... 85 °C
Relative humidity	5 ... 96 % (no condensation permissible)
Derating	≥ 50 °C (see instruction manual)
Pollution degree	2

Standards and specifications

Conformity marking	CE
Standards/Specifications	EN 60950; EN 61000-6-2; EN 61000-6-3; UL 508; UL 2367; DNV GL

Commercial data

Packaging type	BOX
Country of origin	DE
GTIN	4055143899345
Customs tariff number	85363010900

Approvals / Certificates

Country specific Approvals

Logo	Approval	Additional Approval Text	Certificate name
	EAC ROSTEST-Moskau	TP TC 020/2011	EAC_Certificate_RU_C- DE.AM02.B.00115_19



Ship Approvals

Logo	Approval	Additional Approval Text	Certificate name
	DNV GL Det Norske Veritas, Germanischer Lloyd	-	TAA0000281

Subject to changes. Please also observe the further product documentation!





UL-Approvals

Logo	Approval	Additional Approval Text	Certificate name
	UL Underwriters Laboratories Inc.	UL 2367	E363438
	UL Underwriters Laboratories Inc.	UL 508	E255817

Compatible products

tools

	Item no.: 210-720 Operating tool; Blade: 3.5 x 0.5 mm; with a partially insulated shaft; multicoloured	www.wago.com/210-720
	Item no.: 210-721 Operating tool; Blade: 5.5 x 0.8 mm; with a partially insulated shaft; multicoloured	www.wago.com/210-721
	Item no.: 210-769 SCREWDRIVER; green	www.wago.com/210-769













ferrule

	Item no.: 216-201 Ferrule; Sleeve for 0.5 mm ² / 20 AWG; insulated; electro-tin plated; white	www.wago.com/216-201
	Item no.: 216-202 Ferrule; Sleeve for 0.75 mm ² / 18 AWG; insulated; electro-tin plated; gray	www.wago.com/216-202
	Item no.: 216-203 Ferrule; Sleeve for 1 mm ² / AWG 18; insulated; electro-tin plated; red	www.wago.com/216-203
	Item no.: 216-204 Ferrule; Sleeve for 1.5 mm ² / AWG 16; insulated; electro-tin plated; black	www.wago.com/216-204
	Item no.: 216-205 Ferrule; Sleeve for 2.08 mm ² / AWG 14; insulated; electro-tin plated; yellow	www.wago.com/216-205
	Item no.: 216-206 Ferrule; Sleeve for 2.5 mm ² / AWG 14; insulated; electro-tin plated; blue	www.wago.com/216-206















Subject to changes. Please also observe the further product documentation!

	Item no.: 216-207 Ferrule; Sleeve for 4 mm ² / AWG 12; insulated; electro-tin plated; gray	www.wago.com/216-207
	Item no.: 216-208 Ferrule; Sleeve for 6 mm ² / AWG 10; insulated; electro-tin plated; electrolytic copper; gastight crimped; acc. to DIN 46228, Part 4/09.90; yellow	www.wago.com/216-208
	Item no.: 216-221 Ferrule; Sleeve for 0.5 mm ² / 20 AWG; insulated; electro-tin plated; white	www.wago.com/216-221
	Item no.: 216-222 Ferrule; Sleeve for 0.75 mm ² / 18 AWG; insulated; electro-tin plated; gray	www.wago.com/216-222
	Item no.: 216-223 Ferrule; Sleeve for 1 mm ² / AWG 18; insulated; electro-tin plated; red	www.wago.com/216-223
	Item no.: 216-224 Ferrule; Sleeve for 1.5 mm ² / AWG 16; insulated; electro-tin plated; black	www.wago.com/216-224
	Item no.: 216-241 Ferrule; Sleeve for 0.5 mm ² / 20 AWG; insulated; electro-tin plated; electrolytic copper; gastight crimped; acc. to DIN 46228, Part 4/09.90; white	www.wago.com/216-241
	Item no.: 216-242 Ferrule; Sleeve for 0.75 mm ² / 18 AWG; insulated; electro-tin plated; electrolytic copper; gastight crimped; acc. to DIN 46228, Part 4/09.90; gray	www.wago.com/216-242
	Item no.: 216-243 Ferrule; Sleeve for 1 mm ² / AWG 18; insulated; electro-tin plated; electrolytic copper; gastight crimped; acc. to DIN 46228, Part 4/09.90; red	www.wago.com/216-243
	Item no.: 216-244 Ferrule; Sleeve for 1.5 mm ² / AWG 16; insulated; electro-tin plated; electrolytic copper; gastight crimped; acc. to DIN 46228, Part 4/09.90; black	www.wago.com/216-244
	Item no.: 216-246 Ferrule; Sleeve for 2.5 mm ² / AWG 14; insulated; electro-tin plated; electrolytic copper; gastight crimped; acc. to DIN 46228, Part 4/09.90; blue	www.wago.com/216-246
	Item no.: 216-262 Ferrule; Sleeve for 0.75 mm ² / 18 AWG; insulated; electro-tin plated; electrolytic copper; gastight crimped; acc. to DIN 46228, Part 4/09.90; gray	www.wago.com/216-262
	Item no.: 216-263 Ferrule; Sleeve for 1 mm ² / AWG 18; insulated; electro-tin plated; electrolytic copper; gastight crimped; acc. to DIN 46228, Part 4/09.90; red	www.wago.com/216-263
	Item no.: 216-264 Ferrule; Sleeve for 1.5 mm ² / AWG 16; insulated; electro-tin plated; electrolytic copper; gastight crimped; acc. to DIN 46228, Part 4/09.90; black	www.wago.com/216-264
	Item no.: 216-266 Ferrule; Sleeve for 2.5 mm ² / AWG 14; insulated; electro-tin plated; electrolytic copper; gastight crimped; acc. to DIN 46228, Part 4/09.90; blue	www.wago.com/216-266
	Item no.: 216-267 Ferrule; Sleeve for 4 mm ² / AWG 12; insulated; electro-tin plated; electrolytic copper; gastight crimped; acc. to DIN 46228, Part 4/09.90; gray	www.wago.com/216-267
	Item no.: 216-284	

Subject to changes. Please also observe the further product documentation!

	Ferrule; Sleeve for 1.5 mm ² / AWG 16; insulated; electro-tin plated; electrolytic copper; gastight crimped; acc. to DIN 46228, Part 4/09.90; black	www.wago.com/216-284
	Item no.: 216-286 Ferrule; Sleeve for 2.5 mm ² / AWG 14; insulated; electro-tin plated; electrolytic copper; gastight crimped; acc. to DIN 46228, Part 4/09.90; blue	www.wago.com/216-286
	Item no.: 216-287 Ferrule; Sleeve for 4 mm ² / AWG 12; insulated; electro-tin plated; electrolytic copper; gastight crimped; acc. to DIN 46228, Part 4/09.90; gray	www.wago.com/216-287
	Item no.: 216-288 Ferrule; Sleeve for 6 mm ² / AWG 10; insulated; electro-tin plated; electrolytic copper; gastight crimped; acc. to DIN 46228, Part 4/09.90; yellow	www.wago.com/216-288
	Item no.: 216-301 Ferrule; Sleeve for 0.25 mm ² / AWG 24; insulated; electro-tin plated; yellow	www.wago.com/216-301
	Item no.: 216-302 Ferrule; Sleeve for 0.34 mm ² / 22 AWG; insulated; electro-tin plated; green	www.wago.com/216-302
	Item no.: 216-321 Ferrule; Sleeve for 0.25 mm ² / AWG 24; insulated; electro-tin plated; yellow	www.wago.com/216-321
	Item no.: 216-322 Ferrule; Sleeve for 0.34 mm ² / 22 AWG; insulated; electro-tin plated; green	www.wago.com/216-322
Marking accessories		
	Item no.: 2009-110 Marking strips; for Smart Printer; on reel; not stretchable; plain; snap-on type; white	www.wago.com/2009-110
	Item no.: 2009-115 WMB-Inline; for Smart Printer; 1500 pieces on roll; stretchable 5 - 5.2 mm; plain; snap-on type; white	www.wago.com/2009-115
	Item no.: 2009-115/000-002 WMB-Inline; for Smart Printer; 1500 pieces on roll; stretchable 5 - 5.2 mm; plain; snap-on type; yellow	www.wago.com/2009-115/000-002
	Item no.: 2009-115/000-006 WMB-Inline; for Smart Printer; 1500 pieces on roll; stretchable 5 - 5.2 mm; plain; snap-on type; blue	www.wago.com/2009-115/000-006
	Item no.: 2009-115/000-007 WMB-Inline; for Smart Printer; 1500 pieces on roll; stretchable 5 - 5.2 mm; plain; snap-on type; gray	www.wago.com/2009-115/000-007
	Item no.: 2009-115/000-012 WMB-Inline; for Smart Printer; 1500 pieces on roll; stretchable 5 - 5.2 mm; plain; snap-on type; orange	www.wago.com/2009-115/000-012
	Item no.: 2009-115/000-017 WMB-Inline; for Smart Printer; 1500 pieces on roll; stretchable 5 - 5.2 mm; plain; snap-on type; light green	www.wago.com/2009-115/000-017

Subject to changes. Please also observe the further product documentation!

	Item no.: 2009-115/000-023 WMB-Inline; for Smart Printer; 1500 pieces on roll; stretchable 5 - 5.2 mm; plain; snap-on type; green	www.wago.com/2009-115/000-023
	Item no.: 2009-115/000-024 WMB-Inline; for Smart Printer; 1500 pieces on roll; stretchable 5 - 5.2 mm; plain; snap-on type; violet	www.wago.com/2009-115/000-024
	Item no.: 2009-145 Mini-WSB Inline; for Smart Printer; 1700 pieces on roll; stretchable 5 - 5.2 mm; plain; snap-on type; white	www.wago.com/2009-145
	Item no.: 2009-145/000-002 Mini-WSB Inline; for Smart Printer; 1700 pieces on roll; stretchable 5 - 5.2 mm; plain; snap-on type; yellow	www.wago.com/2009-145/000-002
	Item no.: 2009-145/000-005 Mini-WSB Inline; for Smart Printer; 1700 pieces on roll; stretchable 5 - 5.2 mm; plain; snap-on type; red	www.wago.com/2009-145/000-005
	Item no.: 2009-145/000-006 Mini-WSB Inline; for Smart Printer; 1700 pieces on roll; stretchable 5 - 5.2 mm; plain; snap-on type; blue	www.wago.com/2009-145/000-006
	Item no.: 2009-145/000-007 Mini-WSB Inline; for Smart Printer; 1700 pieces on roll; stretchable 5 - 5.2 mm; plain; snap-on type; gray	www.wago.com/2009-145/000-007
	Item no.: 2009-145/000-012 Mini-WSB Inline; for Smart Printer; 1700 pieces on roll; stretchable 5 - 5.2 mm; plain; snap-on type; orange	www.wago.com/2009-145/000-012
	Item no.: 2009-145/000-023 Mini-WSB Inline; for Smart Printer; 1700 pieces on roll; stretchable 5 - 5.2 mm; plain; snap-on type; green	www.wago.com/2009-145/000-023
	Item no.: 2009-145/000-024 Mini-WSB Inline; for Smart Printer; 1700 pieces on roll; stretchable 5 - 5.2 mm; plain; snap-on type; violet	www.wago.com/2009-145/000-024
	Item no.: 210-831 Marking strips; on reel; 2.3 mm wide; plain; Self-adhesive; white	www.wago.com/210-831
	Item no.: 210-832 Marking strips; on reel; 3 mm wide; plain; Self-adhesive; white	www.wago.com/210-832
	Item no.: 248-501 Miniature WSB Quick marking system; plain; Marker width 5 mm; 10 strips with 10 markers per card	www.wago.com/248-501
	Item no.: 248-501/000-002 Mini-WSB marking card; as card; not stretchable; plain; snap-on type; yellow	www.wago.com/248-501/000-002

Subject to changes. Please also observe the further product documentation!



Item no.: 248-501/000-005
Mini-WSB marking card; as card; not stretchable; plain; snap-on type; red

www.wago.com/248-501/000-005



Item no.: 248-501/000-006
Mini-WSB marking card; as card; not stretchable; plain; snap-on type; blue

www.wago.com/248-501/000-006



Item no.: 248-501/000-007
Mini-WSB marking card; as card; not stretchable; plain; snap-on type; gray

www.wago.com/248-501/000-007



Item no.: 248-501/000-012
Mini-WSB marking card; as card; not stretchable; plain; snap-on type; orange

www.wago.com/248-501/000-012



Item no.: 248-501/000-017
Mini-WSB marking card; as card; not stretchable; plain; snap-on type; light green

www.wago.com/248-501/000-017



Item no.: 248-501/000-023
Mini-WSB marking card; as card; not stretchable; plain; snap-on type; green

www.wago.com/248-501/000-023



Item no.: 793-501
WMB marking card; as card; not stretchable; plain; snap-on type; white

www.wago.com/793-501



Item no.: 793-501/000-002
WMB marking card; as card; not stretchable; plain; snap-on type; yellow

www.wago.com/793-501/000-002



Item no.: 793-501/000-005
WMB marking card; as card; not stretchable; plain; snap-on type; red

www.wago.com/793-501/000-005



Item no.: 793-501/000-006
WMB marking card; as card; not stretchable; plain; snap-on type; blue

www.wago.com/793-501/000-006



Item no.: 793-501/000-007
WMB marking card; as card; not stretchable; plain; snap-on type; gray

www.wago.com/793-501/000-007



Item no.: 793-501/000-012
WMB marking card; as card; not stretchable; plain; snap-on type; orange

www.wago.com/793-501/000-012



Item no.: 793-501/000-017
WMB marking card; as card; not stretchable; plain; snap-on type; light green

www.wago.com/793-501/000-017

Subject to changes. Please also observe the further product documentation!



Item no.: 793-501/000-023

WMB marking card; as card; not stretchable; plain; snap-on type; green

www.wago.com/793-501/000-023



Item no.: 793-501/000-024

WMB marking card; as card; not stretchable; plain; snap-on type; violet

www.wago.com/793-501/000-024



Item no.: 793-5501

WMB marking card; as card; for terminal block width 5 - 17.5 mm; stretchable 5 - 5.2 mm; plain; snap-on type; white

www.wago.com/793-5501



Item no.: 793-5501/000-002

WMB marking card; as card; for terminal block width 5 - 17.5 mm; stretchable 5 - 5.2 mm; plain; snap-on type; yellow

www.wago.com/793-5501/000-002



Item no.: 793-5501/000-005

WMB marking card; as card; for terminal block width 5 - 17.5 mm; stretchable 5 - 5.2 mm; plain; snap-on type; red

www.wago.com/793-5501/000-005



Item no.: 793-5501/000-006

WMB marking card; as card; for terminal block width 5 - 17.5 mm; stretchable 5 - 5.2 mm; plain; snap-on type; blue

www.wago.com/793-5501/000-006



Item no.: 793-5501/000-007

WMB marking card; as card; for terminal block width 5 - 17.5 mm; stretchable 5 - 5.2 mm; plain; snap-on type; gray

www.wago.com/793-5501/000-007



Item no.: 793-5501/000-012

WMB marking card; as card; for terminal block width 5 - 17.5 mm; stretchable 5 - 5.2 mm; plain; snap-on type; orange

www.wago.com/793-5501/000-012



Item no.: 793-5501/000-014

WMB marking card; as card; for terminal block width 5 - 17.5 mm; stretchable 5 - 5.2 mm; plain; snap-on type; brown

www.wago.com/793-5501/000-014



Item no.: 793-5501/000-017

WMB marking card; as card; for terminal block width 5 - 17.5 mm; stretchable 5 - 5.2 mm; plain; snap-on type; green

www.wago.com/793-5501/000-017



Item no.: 793-5501/000-023

WMB marking card; as card; for terminal block width 5 - 17.5 mm; stretchable 5 - 5.2 mm; plain; snap-on type; light green

www.wago.com/793-5501/000-023



Item no.: 793-5501/000-024

WMB marking card; as card; for terminal block width 5 - 17.5 mm; stretchable 5 - 5.2 mm; plain; snap-on type; violet

www.wago.com/793-5501/000-024

Downloads

Documentation

Manual

Subject to changes. Please also observe the further product documentation!

WAGO Kontakttechnik GmbH & Co. KG

Hansastr. 27

32423 Minden

Phone: +49571 887-0 | Fax: +49571 887-169

Email: info.de@wago.com | Web: www.wago.com

Do you have any questions about our products?

We are always happy to take your call at +49 (571) 887-44222.



Electronic Circuit Breaker 24 VDC / 8 × 1...10 A	V 1.1.0 26. 8. 2019	pdf 5.5 MB	Download
---	------------------------	---------------	----------

Bid Text

787-1668/000-080 X81 - Datei	3. 7. 2019	xml 7.1 kB	Download
---------------------------------	------------	---------------	----------

787-1668/000-080 docx - Datei	3. 7. 2019	docx 20.9 kB	Download
----------------------------------	------------	-----------------	----------

Additional Information

Disposal; Electrical and electronic equipment, Packaging	V 1.0.0	pdf 265.8 kB	Download
--	---------	-----------------	----------

Application Notes

Application note SIEMENS

Application note Electronic fuse 787-166x/0000-0080 with I/O-Link Interface (a2019004)	2019-06-06 6. 6. 2019	zip 7.4 MB	Download
--	--------------------------	---------------	----------

This application note describes how the WAGO electronic fuses (787-1668 / 0000-0080 or 787-1664 / 0000-0080) with I/O-Link interface are integrated in the TIA Portal V15. The fuse is operated either on a Wago I/O-Link master or on a Siemens I/O-Link master.

Application note Electronic fuse 787-166x/0000-0080 with I/O-Link Interface (a2019005)	2019-06-06 6. 6. 2019	zip 11.0 MB	Download
--	--------------------------	----------------	----------

This Application Note explains how the WAGO electronic fuses (787-1668/0000-0080 and 787-1664/0000-0080) with I/O link interface are integrated into the SIMATIC Manager V5.5.

Application Note e!COCKPIT

e!COCKPIT application note WagoAppFuse (a2019001)	2019-09-17 17. 9. 2019	pdf 863.9 kB	Download
---	---------------------------	-----------------	----------

In this Application Note, an example project for the library "WagoAppFuse" is delivered. The electronic circuit breaker (ECB) is connected to an IO-Link master module 750-657.

Engineering-Software

WAGO IO-Link Configurator

WAGO IO-Link Configurator	V5.1.1	ZIP	Download
---------------------------	--------	-----	----------

Subject to changes. Please also observe the further product documentation!

WAGO Kontakttechnik GmbH & Co. KG

Hansastr. 27

32423 Minden

Phone: +49571 887-0 | Fax: +49571 887-169

Email: info.de@wago.com | Web: www.wago.com

Do you have any questions about our products?

We are always happy to take your call at +49 (571) 887-44222.



The WAGO IO-Link Configurator is standalone commissioning, configuration and management software for the WAGO Field I/O System's IO-Link Master and Hubs.

17. 12. 2020

25.2 MB

It supports all IO-Link devices per the IO-Link specification and allows automatic download of IO-DDs via integrated IO-DD Finder.

Register now and test our engineering software for 30 days at no cost.

CAD/CAE-Data

CAD data

2D/3D Models 787-1668/000-080	URL	Download
-------------------------------	---------------------	--------------------------

CAE data

ZUKEN Portal 787-1668/000-080	URL	Download
-------------------------------	---------------------	--------------------------

EPLAN Data Portal 787-1668/000-080	URL	Download
------------------------------------	---------------------	--------------------------

Device Files

Device Description File

Device description files 787-1668/000-080 for firmware until version 2.38	1.1 19. 3. 2018	zip 156.0 kB	Download
--	--------------------	-----------------	--------------------------

Device description files 787-1668/000-080 for firmware version 2.39 and higher	1.4.1 10. 9. 2019	zip 156.2 kB	Download
---	----------------------	-----------------	--------------------------

Environmental Product Compliance

Compliance Search

Environmental Product Compliance 787-1668/000-080 Electronic circuit breaker; 8-channel; 24 VDC input voltage; adjustable 1 ... 10 A; IO-Link	URL	Download
--	---------------------	--------------------------

Installation Notes

Subject to changes. Please also observe the further product documentation!