

Data sheet | Item number: 2202-1661

2-conductor carrier terminal block; with push-button; for DIN-rail 35 x 15 and 35 x 7.5; 2.5 mm²; Push-in CAGE CLAMP®; 2,50 mm²; gray

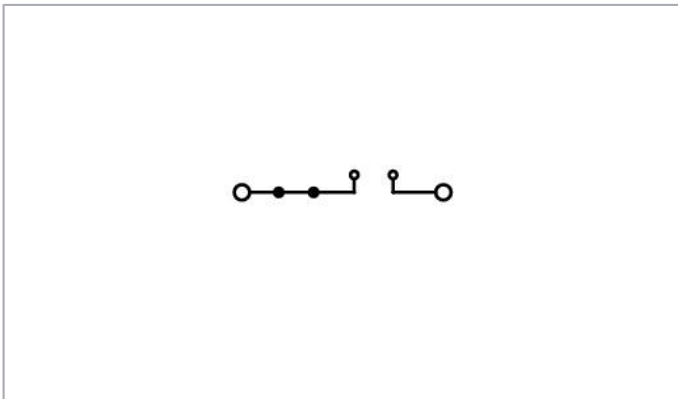

www.wago.com/2202-1661

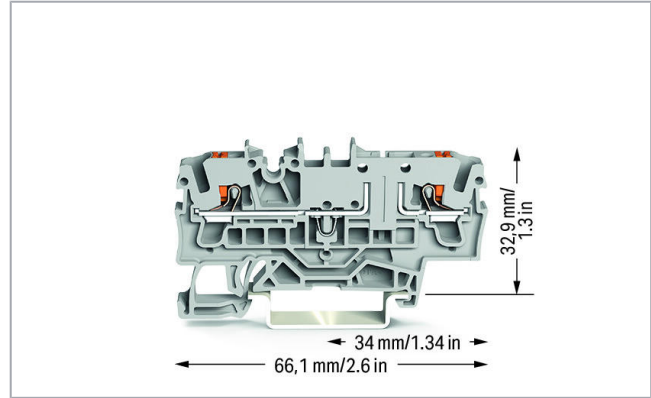
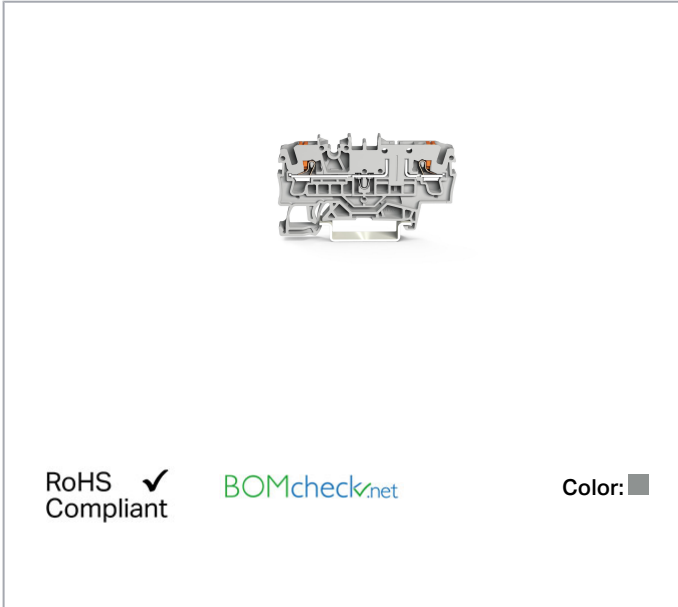

Data

Electrical data

Ratings per IEC/EN

Ratings per	IEC/EN 60947-7-1
Nominal voltage (III/3)	400 V
Rated surge voltage (III/3)	6 kV
Rated current	16 A

Subject to changes. Please also observe the further product documentation!

WAGO Kontakttechnik GmbH & Co. KG
Hansastr. 27
32423 Minden
Phone: +49571 887-0 | Fax: +49571 887-169
Email: info.de@wago.com | Web: www.wago.com

Do you have any questions about our products?
We are always happy to take your call at 01788 568 008.

Legend (ratings)

(III / 3) ≙ Overvoltage category III / Pollution degree 3

Ratings per UL

Approvals per	UL 1059
Rated voltage UL (Use Group B)	300 V
Rated current UL (Use Group B)	15 A
Rated voltage UL (Use Group C)	300 V
Rated current UL (Use Group C)	15 A

Ratings per CSA

Approvals per	C22.2 No 158
Rated voltage CSA (Use Group B)	300 V
Rated current CSA (Use Group B)	15 A
Rated voltage CSA (Use Group C)	300 V
Rated current CSA (Use Group C)	15 A

Connection data

Connection technology	Push-in CAGE CLAMP®
Actuation type	Push-in Push-button Operating tool
Connectable conductor materials	Copper
Nominal cross-section	2.5 mm ²
Solid conductor	0.25 ... 4 mm ² / 22 ... 12 AWG
Solid conductor; push-in termination	0.75 ... 4 mm ² / 18 ... 12 AWG
Fine-stranded conductor	0.25 ... 4 mm ² / 22 ... 12 AWG
Fine-stranded conductor; with insulated ferrule	1 ... 2.5 mm ² / 18 ... 14 AWG
Fine-stranded conductor; with ferrule; push-in termination	1 ... 2.5 mm ² / 18 ... 14 AWG
Note (conductor cross-section)	Depending on the conductor characteristic, a conductor with a smaller cross-section can also be inserted via push-in termination.
Strip length	10 ... 12 mm / 0.39 ... 0.47 inch
Total number of connection points	2
Total number of potentials	2
Number of levels	1
Wiring type	Front-entry wiring
Number of jumper slots	2

Subject to changes. Please also observe the further product documentation!

Physical data

Width	5.2 mm / 0.205 inch
Height	66.1 mm / 2.602 inch
Height from upper-edge of DIN-rail	32.9 mm / 1.295 inch
Depth	66.1 mm / 2.602 inch

Mechanical data

Design	horizontal type
Mounting type	DIN-35 rail
Marking level	Center/side marking

Material data



Color	gray
Insulation material	Polyamide (PA66)
Weight	7.3 g

Commercial data

Packaging type	BOX
Country of origin	DE
GTIN	4055143907729
Customs tariff number	85369010000

Approvals / Certificates

Ex-Approvals

Logo	Approval	Additional Approval Text	Certificate name
 	AEx Underwriters Laboratories Inc.	UL 60079	E185892
 Ex nA IIC Gc	CCCEX CQST/CNEX	CNCA-C23-01	2020312313000288

UL-Approvals

Logo	Approval	Additional Approval Text	Certificate name
	UL	UL 1059	E45172

Subject to changes. Please also observe the further product documentation!

Underwriters Laboratories Inc.



Required accessories

End plate



Item no.: 2002-1691

End and intermediate plate; 1 mm thick; gray

www.wago.com/2002-1691



Item no.: 2002-1692

End and intermediate plate; 1 mm thick; orange

www.wago.com/2002-1692

Compatible products

Jumper



Item no.: 2002-400

Continuous jumper; 2-way; insulated; light gray

www.wago.com/2002-400



Item no.: 2002-402

Jumper; 2-way; insulated; light gray

www.wago.com/2002-402



Item no.: 2002-402/000-005

Jumper; 2-way; insulated; red

www.wago.com/2002-402/000-005



Item no.: 2002-402/000-006

Jumper; 2-way; insulated; blue

www.wago.com/2002-402/000-006



Item no.: 2002-403

Jumper; 3-way; insulated; light gray

www.wago.com/2002-403



Item no.: 2002-403/000-005

Jumper; 3-way; insulated; red

www.wago.com/2002-403/000-005



Item no.: 2002-403/000-006

Jumper; 3-way; insulated; blue

www.wago.com/2002-403/000-006



Item no.: 2002-404

Jumper; 4-way; insulated; light gray

www.wago.com/2002-404



Item no.: 2002-404/000-005

Jumper; 4-way; insulated; red

www.wago.com/2002-404/000-005

Subject to changes. Please also observe the further product documentation!

WAGO Kontakttechnik GmbH & Co. KG

Hansastr. 27















32423 Minden

Phone: +49571 887-0 | Fax: +49571 887-169

Email: info.de@wago.com | Web: www.wago.com

Do you have any questions about our products?

We are always happy to take your call at 01788 568 008.

	Item no.: 2002-404/000-006 Jumper; 4-way; insulated; blue	www.wago.com/2002-404/000-006
	Item no.: 2002-405 Jumper; 5-way; insulated; light gray	www.wago.com/2002-405
	Item no.: 2002-405/000-005 Jumper; 5-way; insulated; red	www.wago.com/2002-405/000-005
	Item no.: 2002-405/000-006 Jumper; 5-way; insulated; blue	www.wago.com/2002-405/000-006
	Item no.: 2002-405/011-000 Star point jumper; 3-way; insulated; light gray	www.wago.com/2002-405/011-000
	Item no.: 2002-406 Jumper; 6-way; insulated; light gray	www.wago.com/2002-406
	Item no.: 2002-406/000-005 Jumper; 6-way; insulated; red	www.wago.com/2002-406/000-005
	Item no.: 2002-406/000-006 Jumper; 6-way; insulated; blue	www.wago.com/2002-406/000-006
	Item no.: 2002-406/020-000 Delta jumper; insulated; light gray	www.wago.com/2002-406/020-000
	Item no.: 2002-407 Jumper; 7-way; insulated; light gray	www.wago.com/2002-407
	Item no.: 2002-407/000-005 Jumper; 7-way; insulated; red	www.wago.com/2002-407/000-005
	Item no.: 2002-407/000-006 Jumper; 7-way; insulated; blue	www.wago.com/2002-407/000-006
	Item no.: 2002-408 Jumper; 8-way; insulated; light gray	www.wago.com/2002-408
	Item no.: 2002-408/000-005 Jumper; 8-way; insulated; red	www.wago.com/2002-408/000-005
	Item no.: 2002-408/000-006 Jumper; 8-way; insulated; blue	www.wago.com/2002-408/000-006

Subject to changes. Please also observe the further product documentation!



Item no.: 2002-409
Jumper; 9-way; insulated; light gray

www.wago.com/2002-409



Item no.: 2002-409/000-005
Jumper; 9-way; insulated; red

www.wago.com/2002-409/000-005



Item no.: 2002-409/000-006
Jumper; 9-way; insulated; blue

www.wago.com/2002-409/000-006



Item no.: 2002-410
Jumper; 10-way; insulated; light gray

www.wago.com/2002-410



Item no.: 2002-410/000-005
Jumper; 10-way; insulated; red

www.wago.com/2002-410/000-005



Item no.: 2002-410/000-006
Jumper; 10-way; insulated; blue

www.wago.com/2002-410/000-006



Item no.: 2002-423
Continuous jumper; from 1 to 3; insulated; light gray

www.wago.com/2002-423



Item no.: 2002-423/000-005
Continuous jumper; from 1 to 3; insulated; red

www.wago.com/2002-423/000-005



Item no.: 2002-423/000-006
Continuous jumper; from 1 to 3; insulated; blue

www.wago.com/2002-423/000-006



Item no.: 2002-433
Jumper; from 1 to 3; insulated; light gray

www.wago.com/2002-433



Item no.: 2002-434
Jumper; from 1 to 4; insulated; light gray

www.wago.com/2002-434



Item no.: 2002-435
Jumper; from 1 to 5; insulated; light gray

www.wago.com/2002-435



Item no.: 2002-436
Jumper; from 1 to 6; insulated; light gray

www.wago.com/2002-436



Item no.: 2002-437
Jumper; from 1 to 7; insulated; light gray













www.wago.com/2002-437



















Item no.: 2002-438
Jumper; from 1 to 8; insulated; light gray

www.wago.com/2002-438

Subject to changes. Please also observe the further product documentation!

	Item no.: 2002-439 Jumper; from 1 to 9; insulated; light gray	www.wago.com/2002-439
	Item no.: 2002-440 Jumper; from 1 to 10; insulated; light gray	www.wago.com/2002-440
	Item no.: 2002-472 Staggered jumper; 2-way; insulated; light gray	www.wago.com/2002-472
	Item no.: 2002-473 Staggered jumper; 3-way; insulated; light gray	www.wago.com/2002-473
	Item no.: 2002-473/011-000 Staggered jumper; 2-way; from 1 to 3; insulated; light gray	www.wago.com/2002-473/011-000
	Item no.: 2002-474 Staggered jumper; 4-way; insulated; light gray	www.wago.com/2002-474
	Item no.: 2002-475 Staggered jumper; 5-way; insulated; light gray	www.wago.com/2002-475
	Item no.: 2002-475/011-000 Staggered jumper; 3-way; insulated; light gray	www.wago.com/2002-475/011-000
	Item no.: 2002-476 Staggered jumper; 6-way; insulated; light gray	www.wago.com/2002-476
	Item no.: 2002-477 Staggered jumper; 7-way; insulated; light gray	www.wago.com/2002-477
	Item no.: 2002-477/011-000 Staggered jumper; insulated; light gray	www.wago.com/2002-477/011-000
	Item no.: 2002-478 Staggered jumper; 8-way; insulated; light gray	www.wago.com/2002-478
	Item no.: 2002-479 Staggered jumper; 9-way; insulated; light gray	www.wago.com/2002-479
	Item no.: 2002-479/011-000 Staggered jumper; insulated; light gray	www.wago.com/2002-479/011-000
	Item no.: 2002-480 Staggered jumper; 10-way; insulated; light gray	www.wago.com/2002-480
	Item no.: 2002-481 Staggered jumper; 11-way; insulated; light gray	www.wago.com/2002-481
	Item no.: 2002-481/011-000 Staggered jumper; insulated; light gray	www.wago.com/2002-481/011-000

Subject to changes. Please also observe the further product documentation!

	Item no.: 2002-482 Staggered jumper; 12-way; insulated; light gray	www.wago.com/2002-482
	Item no.: 210-103 Wire commoning chain; insulated; black	www.wago.com/210-103
	Item no.: 210-123 Wire commoning chain; insulated; blue	www.wago.com/210-123
Carrier rail		
	Item no.: 210-112 Steel carrier rail; 35 x 7.5 mm; 1 mm thick; 2 m long; slotted; according to EN 60715; "Hole width 25 mm; silver-colored	www.wago.com/210-112
	Item no.: 210-113 Steel carrier rail; 35 x 7.5 mm; 1 mm thick; 2 m long; unslotted; according to EN 60715; silver-colored	www.wago.com/210-113
	Item no.: 210-114 Steel carrier rail; 35 x 15 mm; 1.5 mm thick; 2 m long; unslotted; similar to EN 60715; silver-colored	www.wago.com/210-114
	Item no.: 210-115 Steel carrier rail; 35 x 7.5 mm; 1 mm thick; 2 m long; slotted; according to EN 60715; "Hole width 18 mm; silver-colored	www.wago.com/210-115
	Item no.: 210-118 Steel carrier rail; 35 x 15 mm; 2.3 mm thick; 2 m long; unslotted; according to EN 60715; silver-colored	www.wago.com/210-118
	Item no.: 210-196 Aluminum carrier rail; 35 x 8.2 mm; 1.6 mm thick; 2 m long; unslotted; similar to EN 60715; silver-colored	www.wago.com/210-196
	Item no.: 210-197 Steel carrier rail; 35 x 15 mm; 1.5 mm thick; 2 m long; slotted; similar to EN 60715; silver-colored	www.wago.com/210-197
	Item no.: 210-198 Copper carrier rail; 35 x 15 mm; 2.3 mm thick; 2 m long; unslotted; according to EN 60715; copper-colored	www.wago.com/210-198
	Item no.: 210-504 Steel carrier rail; 35 x 7.5 mm; 1 mm thick; 2 m long; slotted; galvanized; according to EN 60715; silver-colored	www.wago.com/210-504
	Item no.: 210-505 Steel carrier rail; 35 x 7.5 mm; 1 mm thick; 2 m long; unslotted; galvanized; according to EN 60715; silver-colored	www.wago.com/210-505
	Item no.: 210-506 Steel carrier rail; 35 x 15 mm; 1.5 mm thick; 2 m long; unslotted; galvanized; similar to EN 60715; silver-colored	www.wago.com/210-506
	Item no.: 210-508 Steel carrier rail; 35 x 15 mm; 1.5 mm thick; 2 m long; slotted; galvanized; similar to EN 60715; silver-colored	www.wago.com/210-508
Insulation stop		
	Item no.: 2002-171 Insulation stop; 0.25 - 0.5 mm ² ; 5 pieces/strip; light gray	www.wago.com/2002-171

Subject to changes. Please also observe the further product documentation!



Item no.: 2002-172
Insulation stop; 0.75 - 1 mm²; 5 pieces/strip; dark gray

www.wago.com/2002-172

ferrule



Item no.: 216-241
Ferrule; Sleeve for 0.5 mm² / 20 AWG; insulated; electro-tin plated; electrolytic copper; gastight crimped; acc. to DIN 46228, Part 4/09.90; white

www.wago.com/216-241



Item no.: 216-242
Ferrule; Sleeve for 0.75 mm² / 18 AWG; insulated; electro-tin plated; electrolytic copper; gastight crimped; acc. to DIN 46228, Part 4/09.90; gray

www.wago.com/216-242



Item no.: 216-243
Ferrule; Sleeve for 1 mm² / AWG 18; insulated; electro-tin plated; electrolytic copper; gastight crimped; acc. to DIN 46228, Part 4/09.90; red

www.wago.com/216-243



Item no.: 216-244
Ferrule; Sleeve for 1.5 mm² / AWG 16; insulated; electro-tin plated; electrolytic copper; gastight crimped; acc. to DIN 46228, Part 4/09.90; black

www.wago.com/216-244



Item no.: 216-246
Ferrule; Sleeve for 2.5 mm² / AWG 14; insulated; electro-tin plated; electrolytic copper; gastight crimped; acc. to DIN 46228, Part 4/09.90; blue

www.wago.com/216-246



Item no.: 216-262
Ferrule; Sleeve for 0.75 mm² / 18 AWG; insulated; electro-tin plated; electrolytic copper; gastight crimped; acc. to DIN 46228, Part 4/09.90; gray

www.wago.com/216-262



Item no.: 216-263
Ferrule; Sleeve for 1 mm² / AWG 18; insulated; electro-tin plated; electrolytic copper; gastight crimped; acc. to DIN 46228, Part 4/09.90; red

www.wago.com/216-263



Item no.: 216-264
Ferrule; Sleeve for 1.5 mm² / AWG 16; insulated; electro-tin plated; electrolytic copper; gastight crimped; acc. to DIN 46228, Part 4/09.90; black

www.wago.com/216-264



Item no.: 216-266
Ferrule; Sleeve for 2.5 mm² / AWG 14; insulated; electro-tin plated; electrolytic copper; gastight crimped; acc. to DIN 46228, Part 4/09.90; blue

www.wago.com/216-266

tools



Item no.: 210-658
Operating tool; Blade: 3.5 x 0.5 mm; with a partially insulated shaft; angled; short; multicoloured

www.wago.com/210-658



Item no.: 210-720
Operating tool; Blade: 3.5 x 0.5 mm; with a partially insulated shaft; multicoloured

www.wago.com/210-720

Push-In type wire jumper



Item no.: 2009-412
Push-in type wire jumper; insulated; 60 mm long; black

www.wago.com/2009-412



Item no.: 2009-414
Push-in type wire jumper; 1.5 mm²; insulated; 110 mm long; black















www.wago.com/2009-414

















Item no.: 2009-414/000-005
Push-in type wire jumper; 1.5 mm²; insulated; 110 mm long; black

www.wago.com/2009-414/000-005

Subject to changes. Please also observe the further product documentation!

	Item no.: 2009-414/000-006 Push-in type wire jumper; insulated; 110 mm long; black	www.wago.com/2009-414/000-006
	Item no.: 2009-416 Push-in type wire jumper; 1.5 mm ² ; insulated; 250 mm long; black	www.wago.com/2009-416
check		
	Item no.: 210-136 Test plug; 2 mm Ø; with 500 mm cable; red	www.wago.com/210-136
General accessories		
	Item no.: 2002-401 Disconnect plug for carrier terminal blocks; for using a receptacle terminal block as a disconnect terminal block; orange	www.wago.com/2002-401
Marking accessories		
	Item no.: 2002-121 Adaptor; gray	www.wago.com/2002-121
	Item no.: 2002-161 Adaptor; gray	www.wago.com/2002-161
	Item no.: 2009-110 Marking strips; for Smart Printer; on reel; not stretchable; plain; snap-on type; white	www.wago.com/2009-110
	Item no.: 2009-115 WMB-Inline; for Smart Printer; 1500 pieces on roll; stretchable 5 - 5.2 mm; plain; snap-on type; white	www.wago.com/2009-115
	Item no.: 2009-115/000-002 WMB-Inline; for Smart Printer; 1500 pieces on roll; stretchable 5 - 5.2 mm; plain; snap-on type; yellow	www.wago.com/2009-115/000-002
	Item no.: 2009-115/000-005 WMB-Inline; for Smart Printer; 1500 pieces on roll; stretchable 5 - 5.2 mm; plain; snap-on type; red	www.wago.com/2009-115/000-005
	Item no.: 2009-115/000-006 WMB-Inline; for Smart Printer; 1500 pieces on roll; stretchable 5 - 5.2 mm; plain; snap-on type; blue	www.wago.com/2009-115/000-006
	Item no.: 2009-115/000-007 WMB-Inline; for Smart Printer; 1500 pieces on roll; stretchable 5 - 5.2 mm; plain; snap-on type; gray	www.wago.com/2009-115/000-007
	Item no.: 2009-115/000-012 WMB-Inline; for Smart Printer; 1500 pieces on roll; stretchable 5 - 5.2 mm; plain; snap-on type; orange	www.wago.com/2009-115/000-012
	Item no.: 2009-115/000-017 WMB-Inline; for Smart Printer; 1500 pieces on roll; stretchable 5 - 5.2 mm; plain; snap-on type; light green	www.wago.com/2009-115/000-017

Subject to changes. Please also observe the further product documentation!

	Item no.: 2009-115/000-023 WMB-Inline; for Smart Printer; 1500 pieces on roll; stretchable 5 - 5.2 mm; plain; snap-on type; green	www.wago.com/2009-115/000-023
	Item no.: 2009-115/000-024 WMB-Inline; for Smart Printer; 1500 pieces on roll; stretchable 5 - 5.2 mm; plain; snap-on type; violet	www.wago.com/2009-115/000-024
	Item no.: 2009-145 Mini-WSB Inline; for Smart Printer; 1700 pieces on roll; stretchable 5 - 5.2 mm; plain; snap-on type; white	www.wago.com/2009-145
	Item no.: 2009-145/000-002 Mini-WSB Inline; for Smart Printer; 1700 pieces on roll; stretchable 5 - 5.2 mm; plain; snap-on type; yellow	www.wago.com/2009-145/000-002
	Item no.: 2009-145/000-005 Mini-WSB Inline; for Smart Printer; 1700 pieces on roll; stretchable 5 - 5.2 mm; plain; snap-on type; red	www.wago.com/2009-145/000-005
	Item no.: 2009-145/000-006 Mini-WSB Inline; for Smart Printer; 1700 pieces on roll; stretchable 5 - 5.2 mm; plain; snap-on type; blue	www.wago.com/2009-145/000-006
	Item no.: 2009-145/000-007 Mini-WSB Inline; for Smart Printer; 1700 pieces on roll; stretchable 5 - 5.2 mm; plain; snap-on type; gray	www.wago.com/2009-145/000-007
	Item no.: 2009-145/000-012 Mini-WSB Inline; for Smart Printer; 1700 pieces on roll; stretchable 5 - 5.2 mm; plain; snap-on type; orange	www.wago.com/2009-145/000-012
	Item no.: 2009-145/000-023 Mini-WSB Inline; for Smart Printer; 1700 pieces on roll; stretchable 5 - 5.2 mm; plain; snap-on type; green	www.wago.com/2009-145/000-023
	Item no.: 2009-145/000-024 Mini-WSB Inline; for Smart Printer; 1700 pieces on roll; stretchable 5 - 5.2 mm; plain; snap-on type; violet	www.wago.com/2009-145/000-024
	Item no.: 248-501 Miniature WSB Quick marking system; plain; Marker width 5 mm; 10 strips with 10 markers per card	www.wago.com/248-501
	Item no.: 248-501/000-002 Mini-WSB marking card; as card; not stretchable; plain; snap-on type; yellow	www.wago.com/248-501/000-002
	Item no.: 248-501/000-005 Mini-WSB marking card; as card; not stretchable; plain; snap-on type; red	www.wago.com/248-501/000-005
	Item no.: 248-501/000-006 Mini-WSB marking card; as card; not stretchable; plain; snap-on type; blue	www.wago.com/248-501/000-006

Subject to changes. Please also observe the further product documentation!



Item no.: 248-501/000-007
Mini-WSB marking card; as card; not stretchable; plain; snap-on type; gray

www.wago.com/248-501/000-007



Item no.: 248-501/000-012
Mini-WSB marking card; as card; not stretchable; plain; snap-on type; orange

www.wago.com/248-501/000-012



Item no.: 248-501/000-017
Mini-WSB marking card; as card; not stretchable; plain; snap-on type; light green

www.wago.com/248-501/000-017



Item no.: 248-501/000-023
Mini-WSB marking card; as card; not stretchable; plain; snap-on type; green

www.wago.com/248-501/000-023



Item no.: 248-501/000-024
Mini-WSB marking card; as card; not stretchable; plain; snap-on type; violet

www.wago.com/248-501/000-024



Item no.: 793-501
WMB marking card; as card; not stretchable; plain; snap-on type; white

www.wago.com/793-501



Item no.: 793-501/000-002
WMB marking card; as card; not stretchable; plain; snap-on type; yellow

www.wago.com/793-501/000-002



Item no.: 793-501/000-005
WMB marking card; as card; not stretchable; plain; snap-on type; red

www.wago.com/793-501/000-005



Item no.: 793-501/000-006
WMB marking card; as card; not stretchable; plain; snap-on type; blue

www.wago.com/793-501/000-006



Item no.: 793-501/000-007
WMB marking card; as card; not stretchable; plain; snap-on type; gray

www.wago.com/793-501/000-007



Item no.: 793-501/000-012
WMB marking card; as card; not stretchable; plain; snap-on type; orange

www.wago.com/793-501/000-012



Item no.: 793-501/000-017
WMB marking card; as card; not stretchable; plain; snap-on type; light green

www.wago.com/793-501/000-017



Item no.: 793-501/000-023
WMB marking card; as card; not stretchable; plain; snap-on type; green

www.wago.com/793-501/000-023

Subject to changes. Please also observe the further product documentation!



Item no.: 793-501/000-024

WMB marking card; as card; not stretchable; plain; snap-on type; violet

www.wago.com/793-501/000-024



Item no.: 793-5501

WMB marking card; as card; for terminal block width 5 - 17.5 mm; stretchable 5 - 5.2 mm; plain; snap-on type; white

www.wago.com/793-5501



Item no.: 793-5501/000-002

WMB marking card; as card; for terminal block width 5 - 17.5 mm; stretchable 5 - 5.2 mm; plain; snap-on type; yellow

www.wago.com/793-5501/000-002



Item no.: 793-5501/000-005

WMB marking card; as card; for terminal block width 5 - 17.5 mm; stretchable 5 - 5.2 mm; plain; snap-on type; red

www.wago.com/793-5501/000-005



Item no.: 793-5501/000-006

WMB marking card; as card; for terminal block width 5 - 17.5 mm; stretchable 5 - 5.2 mm; plain; snap-on type; blue

www.wago.com/793-5501/000-006



Item no.: 793-5501/000-007

WMB marking card; as card; for terminal block width 5 - 17.5 mm; stretchable 5 - 5.2 mm; plain; snap-on type; gray

www.wago.com/793-5501/000-007



Item no.: 793-5501/000-012

WMB marking card; as card; for terminal block width 5 - 17.5 mm; stretchable 5 - 5.2 mm; plain; snap-on type; orange

www.wago.com/793-5501/000-012



Item no.: 793-5501/000-014

WMB marking card; as card; for terminal block width 5 - 17.5 mm; stretchable 5 - 5.2 mm; plain; snap-on type; brown

www.wago.com/793-5501/000-014



Item no.: 793-5501/000-017

WMB marking card; as card; for terminal block width 5 - 17.5 mm; stretchable 5 - 5.2 mm; plain; snap-on type; green

www.wago.com/793-5501/000-017



Item no.: 793-5501/000-023

WMB marking card; as card; for terminal block width 5 - 17.5 mm; stretchable 5 - 5.2 mm; plain; snap-on type; light green

www.wago.com/793-5501/000-023



Item no.: 793-5501/000-024

WMB marking card; as card; for terminal block width 5 - 17.5 mm; stretchable 5 - 5.2 mm; plain; snap-on type; violet

www.wago.com/793-5501/000-024

plug



Item no.: 2002-800

Empty component plug housing; 5.2 mm wide; 2-pole; Type 1; gray

www.wago.com/2002-800















Item no.: 2002-800/1000-410

Component plug; for carrier terminal blocks; 2-pole; with diode 1N4007; anode, left side; 5.2 mm wide; Operating temperature 85°C max.; gray

www.wago.com/2002-800/1000-410

Subject to changes. Please also observe the further product documentation!

	Item no.: 2002-800/1000-411 Component plug; for carrier terminal blocks; 2-pole; with diode 1N4007; 5.2 mm wide; Operating temperature 85°C max.; gray	www.wago.com/2002-800/1000-411
	Item no.: 2002-800/1000-541 Component plug; for carrier terminal blocks; 1-pole; LED (red); 5.2 mm wide; Operating temperature 85°C max.; gray	www.wago.com/2002-800/1000-541
	Item no.: 2002-800/1000-542 Component plug; for carrier terminal blocks; 1-pole; LED (red); 5.2 mm wide; Operating temperature 85°C max.; gray	www.wago.com/2002-800/1000-542
	Item no.: 2002-800/1000-836 Component plug; for carrier terminal blocks; 1-pole; LED (red); 5.2 mm wide; Operating temperature 85°C max.; gray	www.wago.com/2002-800/1000-836
	Item no.: 2002-810 Empty component plug housing; 10.4 mm wide; 2-pole; Type 2; gray	www.wago.com/2002-810
	Item no.: 2002-820 Empty component plug housing; 10.4 mm wide; 4-pole; Type 3; gray	www.wago.com/2002-820
	Item no.: 2003-911 Double fuse plug; for 5 x 20 mm miniature metric fuse; without blown fuse indication; 10.4 mm wide; gray	www.wago.com/2003-911
	Item no.: 2003-911/1000-923 Double fuse plug; for 5 x 20 mm miniature metric fuse; with indicator lamp; 230 V; 10.4 mm wide; gray	www.wago.com/2003-911/1000-923
	Item no.: 2004-911 Fuse plug; with pull-tab; for miniature metric fuses 5 x 20 mm and 5 x 25 mm; without blown fuse indication; 6.1 mm wide; gray	www.wago.com/2004-911
	Item no.: 2004-911/1000-541 Fuse plug; with pull-tab; for 5 x 20 mm miniature metric fuse; with indicator lamp; 12 - 30 V; 6.1 mm wide; gray	www.wago.com/2004-911/1000-541
	Item no.: 2004-911/1000-542 Fuse plug; with pull-tab; for 5 x 20 mm miniature metric fuse; with indicator lamp; 30 - 65 V; 6.1 mm wide; gray	www.wago.com/2004-911/1000-542
	Item no.: 2004-911/1000-836 Fuse plug; with pull-tab; for 5 x 20 mm miniature metric fuse; with indicator lamp; 230 V; 6.1 mm wide; gray	www.wago.com/2004-911/1000-836
	Item no.: 2004-911/1000-867 Fuse plug; with pull-tab; for 5 x 20 mm miniature metric fuse; with indicator lamp; 120 V; 6.1 mm wide; gray	www.wago.com/2004-911/1000-867

Subject to changes. Please also observe the further product documentation!

Downloads

Documentation

Additional Information

Technical explanations

3. 4. 2019

pdf
2.2 MB

Download

Installation Notes

Conductor termination

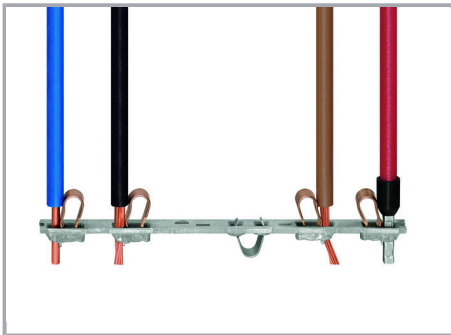

All conductor types at a glance

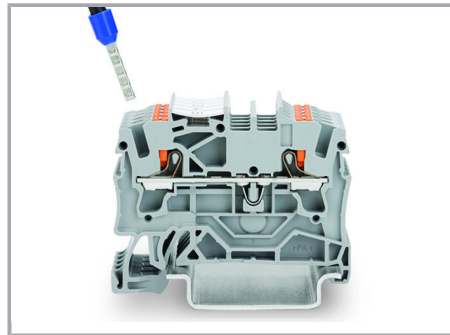

Push-in termination of solid and ferruled conductors

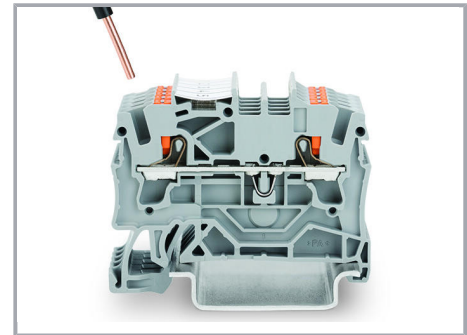

Push-in termination of solid and ferruled conductors



Insert fine-stranded conductors via operating tool.

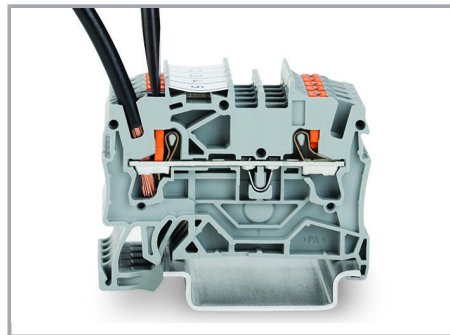

Removing all conductors via operating tool.

Commoning

Subject to changes. Please also observe the further product documentation!

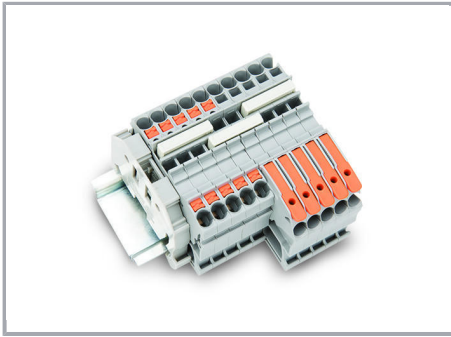

Insert a push-in type jumper bar and push down until it hits the backstop.

Marking

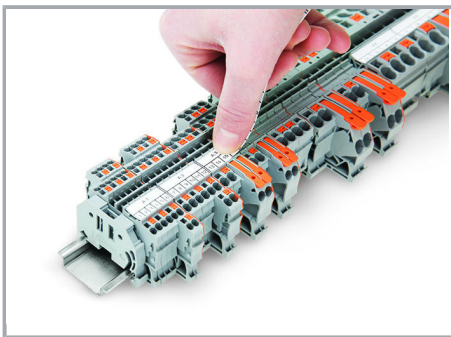

Snapping a marking strip into a marker slot.

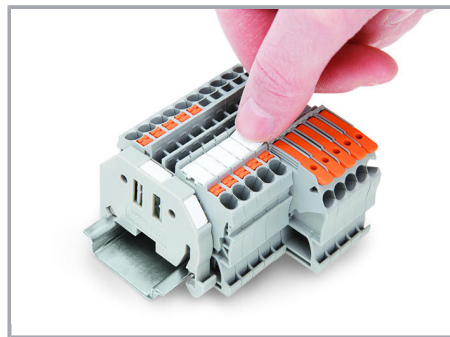

Snapping a marking strip into the marker slot.

Product family

TOPJOB® S

TOPJOB® S: In various industrial applications and modern building installations, WAGO's wide and versatile range of rail-mount terminal blocks provides more than just reliable electrical connections.

[Show all products from the family](#)

Subject to changes. Please also observe the further product documentation!